



# Basic Guide

## Hitachi Inverter

### Communication Option for the PROFIBUS

#### P1-PB

NT2561X

## 1. Introduction

---

Thank you for purchasing the P1-PB: communication option for Hitachi SJ series P1 (afterward, "Hitachi SJ series P1" referred as SJ-P1). This basic guide describes how to handle and maintain the P1-PB. Please read this guide carefully before using the P1-PB, and keep it handy for those who operate, maintain and inspect it.

For the purpose of reducing paper consumption and provision of the latest information, we enclose the Basic Guide only, while providing the User's Guide for more detailed description through electronic data instead of CD or printed document.

### ■About the Basic Guide (this document)

The Basic Guide provides the minimum information necessary for handling the product. Please make sure to read the Basic Guide as well as the User's Guide for more detailed information.

### ■About the User's Guide

The User's Guide provides detailed information necessary for handling the product. Please make sure to read User's Guide for proper use.

If future updated descriptions differ from the Basic Guide, the description in the User's Guide will have higher priority. Always use the P1-PB strictly within the range described in the User's Guide and perform proper inspection and maintenance to prevent failures or accidents.

The latest version of the User's guide can be obtained through our website. In case it is not available or cannot be downloaded, please contact the nearest sales office.

### ■Handling the inverter

For handling the inverter, please make sure to read its Basic Guide and User's Guide.

## 2. Cautions

---

### ■For a proper use

Before using the inverter, please read carefully the inverter's Basic and User's Guide, the P1-PB User's Guide and this guide.

In Addition any personnel handling or performing maintenance of the product must read carefully the inverter's Basic and User's Guide, the P1-PB User's Guide and this guide.

Before any attempt to install, operate, maintain or inspect this equipment, a complete understanding of the equipment specifications, safety instructions, precautions, handling and operation instructions is required. Please follow all the specifications and instructions for a proper use. Additionally, periodically review the inverter's Basic and User's Guide, the P1-PB User's Guide and this guide.

### ■Precautions

It is prohibited to reproduce or reform this document partially or totally in any form without the publisher's permission.

The contents of the document are subject to change without prior notice.

Any handling, maintenance or operation method NOT described on the inverter's Basic and User's Guide, the P1-PB User's Guide or this guide is not covered by the product warranty. Please DO NOT perform any procedure NOT described on the SJ-P1 or the P1-PB guides since it can be the cause of unexpected failures or accidents.

We are not responsible for any impact from operations regardless of unexpected failure or accident due to operation or handling of the product in a manner not specified on the inverter's Basic and User's Guide, the P1-PB User's Guide or this guide. We appreciate your understanding.

If you find any unclear or incorrect description, missing description or misplaced or missing pages, Please inform the Hitachi inverter technical service office.

Note that, in case the inverter's Basic and User's Guide, the P1-PB User's Guide and this guide are enclosed, they should be delivered to the end user of the inverter. Also make sure to download and keep accessible any other related guides or instructions for the end user.

### 3. Product Warranty and Inquiry

#### ■ About Product Inquiry

- For an inquiry about product damage or faults or a question about the product, notify your supplier or Hitachi inverter technical service office.

When contacting the technical service, please provide the following information.

- Model: P1-PB
- Manufacture Number (MFG No.): It shows on the name plate. (Please refer to the chapter 8-9, for more information)
- Date of Purchase: Purchase date by the customer
- Inquiry contents:
  - Inform us the defective point and its condition.
  - Inform us the suspicious content and its details.

#### ■ Product Warranty

- The product P1-PB will be warranted by Hitachi Industrial Equipment Systems Co., Ltd. (afterwards referred as "Hitachi") during the warranty period from your date of purchase only under proper usage of product.
- However, the warranty expressed here is covered only for products delivered from Hitachi, and will not be responsible for others damage or loss of products like a motor or any equipment or systems damage caused by improper usage of the product. We recommend applying safety design which is able to provide a hazard notice to the user in case of malfunction or damage of the delivered product to minimize the consequences on other equipment or system. We advise that the selection of the delivered product is done with sufficient margin for performance, as well as using redundant design for other equipment or systems. Also, the compatibility of the product with the customer's intended use is not warranted, hence the customer has the responsibility to perform validation tests before any operation.
- In case a defective product is delivered, or quality failure during the manufacturing process are detected, Hitachi will repair or exchange the product free of charge, only during the product warranty period (afterward, we call "warranty service" ).

- The product will be warranted for one year from the date of purchase. However, depending on the case, actual expenses for sending technical assistance will be charged to the customer. Also, Hitachi will not be responsible of any readjustment or testing on site.
- After a warranty service, the exchanged or repaired part will be warranted for 6 months from the date of the warranty service. Hitachi will be responsible for repairing or exchanging the previously exchanged or repaired part only during this warranty period
- Please verify that the inverter settings are adequate for operation, before operating it remotely through the network.
- In order to receive warranty service, you should present the receipt issued by the product supplier or any other document that allow us to check the purchase date. However, any defects, damage, malfunction or any other failure caused by one of the following facts will not be covered by warranty service.

- (1) Cannot confirm the purchase date.
- (2) The damage or fault resulted from improper usage or inadequate handling of the product or usage that does not comply with the instructions described in the user's guide or basic guide.
- (3) Incorrect usage of the product and/or the inverter, inadequate setting of the product and/or the inverter, remodeling or inadequate repair or repair carried out by an unqualified repair center.
- (4) Deterioration and wear as result of normal operation.
- (5) Fault resulted from natural disaster, such as earthquake, fire disaster, lightning strike, pollution, salt pollution, or abnormal voltage or any others external factors.
- (6) Shock, falling, or Vibration resulted during transportation or displacement after purchase.
- (7) Damage or fault resulted from remodeling firmware by unqualified personal not belonging to Hitachi.
- (8) Damage or fault resulted from using a function program (EzSQ).
- (9) For overseas use.

## ■ Liability Limitation

- In this product warranty, all warranties offered to the customer are stipulated, and neither Hitachi, affiliated companies or related dealers are liable to any express warranties or implied warranties including, but not limited to, product merchantability or specific application fitness.
- Also, Hitachi, affiliated companies or related dealers are not responsible of any incidental damage, special damage, direct loss, or indirect loss (even predictable or not) sustained by the customer as a result of a faulty product.

## ■ Using the Warranty Service

- The customer is able to receive a warranty service during the warranty period from the product supplier or service station, if the product does not meet the specifications described in user's guide or this guide. However, the user's guide will have priority in case of content mismatch between this and the user's guide.
- A fare-paying service can also be obtained by contacting your supplier, local Hitachi distributor or service station.

## ■ Change on Product Specifications

- Please be aware that the information described in Brochure, Basic Guide, User's Guide or Technical Document might be modified without notice.

## ■ Precautions for Product Operation

- The product should be operated following the working conditions, handling methods and precautions described in User's Guide.
- Please verify that the inverter settings are adequate for operation, before operating it remotely through the network.
- Please verify that the Hitachi inverter is correctly configured and installed for the intended purpose in the designed system.
- When using the Hitachi inverter please implement the following actions.
  - (1) Select an inverter with sufficient capacity for the rated current and performance.
  - (2) Implement safety design such as redundant system design.
  - (3) Implement safety design which minimizes risks in case of an inverter failure.
  - (4) Design the system in a way it can warn the operator about any danger.
  - (5) Carry out periodic maintenance to the customer's equipment as well as the inverter.

- For applications that involve human life, or have risk of an important loss, make sure to avoid a critical accident by installing a fail-safe device, protecting device, detecting device, alarm device, and/or spare device, etc.

## ■ Operation Warranty

- Even though the P1-PB complies with the PROFIBUS standard, we do not guarantee that it will operate properly with all types of master devices.

## ■ Supplement

- This warranty term will not restrict the legal right of customer who has purchased the product.
- This warranty is valid only in Japan(excluding special types of contracts).
- Contact your sales agent for warranty of products purchased overseas.

## 4. Precautions

### 4.1. Please be Careful!



· If handled incorrectly or improperly, it might cause death, serious physical injuries, or damage to the inverter, motor or even the entire system.



· Before installation, wiring, operation, inspection, or usage please read and fully understand this guide.



· In order to explain this device details the illustrations in this guide might show this device without covers.



· Before operating this device please return all the covers to the original position, and follow all the necessary regulations and instructions written in this guide.



· There will be additional warnings about hazards and failure causes in other chapters.



· Before installation, wiring, operation, inspection, or usage please read and fully understand this guide.

### 4.2. Precautions during the installation!



#### ● Risk of Fire !

· DO NOT place inflammable objects nearby.



· DO NOT let scraps of wire, welding sputtering, irons scraps or other objects get inside the device.



· Avoid installing this device in places with high temperature, high humidity, Condensation-prone conditions, dusty conditions, corrosive gas, explosive gas, flammable gas, grinding fluid mist, hydrogen sulfide or salt damage prone conditions. Additionally, it is recommended to install this device in ventilated room not exposed to direct sunlight.



#### ● Risk of an Inverter failure !

· This device is a precision equipment, do not drop it, or give it a strong shock.

· DO NOT get on (step on) or place heavy objects on this device.

· When handling the object, avoid places prone to static electricity(like carpets).



· Since the human body can get charged with static electricity, as a safety measure please touch a safe metallic surface before handling this device.



#### ● Risk of Injury !

· DO NOT install or operate products with damage or missing parts.



### 4.3. Precautions during the wiring!

## Danger

 ● **Risk of an electric shock and/or fire !**

**Electric shock and Fire hazard**

- Be sure to ground the inverter.
- Entrust the wiring work only to a qualified electrician.
- Before the wiring work make sure to turn off the power supply and wait for more than 10 or 15 minutes depending on the inverter model \*). (Confirm that the charge lamp is OFF and the DC voltage between terminals P and N is 45 V or less.)

 Do

 ● **Risk of inverter failure !**

**Failure**

- DO NOT pull any wire after wiring.

 Prohibited

 ● **Risk of an electric shock and/or injury !**

**Electric shock and injury**

- Perform the wiring only after installing the inverter.

 Do

\*) For P1-00044-L to P1-01240-L (P1-004L to P1-220L), P1-00041-H to P1-00620-H (P1-007H to P1-220H) models the wait time is 10 minutes.  
For P1-01530-L to P1-02950-L (P1-300L to P1-550L), P1-00770-H to P1-03160-H (P1-300H to P1-1320H) models the wait time is 15 minutes.

## Warning

● **Risk of an electric shock and/or injury !**

**Electric shock and injury**

- DO NOT operate/switch any of the switches from the 4 pole DIP switch on this device. When this device is shipped all switches are turned off.
- If any of the switches from the 4 pole DIP switch is operated/switched, this device will not work as intended and it might be the cause of failure.
- Please handle the cables properly and do not let them get damaged. Using damaged cables will not only interfere with the correct operation of this device but also might be the cause of a system failure.

 Do

● **Risk of Fire !**

**Fire hazard**

- Please tighten the screws and bolts with the specified torque. (Please refer to the inverter user's guide.)
- Verify that none of the screws and bolts are loose.
- Make sure that the inverter and this device are fixed together with the securing screw.
- Make sure that the connectors are properly fixed.

 Do

4.4. Precautions during operation!

 **Danger**

 ● **Risk of an electric shock or fire !**

**Electric shock and Fire hazard**

- DO NOT touch the inside of this device, check the signal, do any wiring or plug/unplug the connectors while it energized.
- DO NOT insert any sick or rod like objects inside this device while it is energized.

 **Prohibited**

 ● **Risk of an injury and/or fire !**

**Injury and Fire hazard**

- DO NOT touch the inside of this device or the inverter while they are energized

 **Prohibited**

 ● **Risk of an electric shock !**

**Electric shock**

- Make sure to fasten all the screws of this device before turning it on. DO NOT detach this device while it is energized or the inverter capacitors are still charged. Additionally, do not touch the inverter while the inverter capacitors are still charged.
- DO NOT touch this device with wet hands.

 **Prohibited**

 **Do**

 **Warning**

 ● **Risk of an injury and/or device damage !**

**Injury or device Damage**

- By using this device it becomes easier to change the settings and the output frequency of the inverter. When changing the settings or the output frequency of the inverter please make sure that it is within the supported range by the motor and/or the equipment.
- In case this device is being used to make the inverter produce high frequency outputs for a motor or other equipment, make sure with the respective manufacturer that the motor or the equipment can tolerate the high frequency output given by the inverter.
- During operation verify the motor rotation direction, and that there are no irregular sounds or vibrations

 **Do**

#### 4.5. Precautions during Maintenance / Inspection!

### ⚠ Danger

 ● **Risk of an electric shock !**

· Before any maintenance or inspection make sure to turn off the power supply and wait for more than 10 or 15 minutes depending on the inverter model \*). (Confirm that the charge lamp is OFF and the DC voltage between terminals P and N is 45 V or less.)

 Do

 · Entrust the maintenance, inspection and/or part replacement only to a specialized personnel. (Be sure to remove wristwatches and metal accessories, e.g., bracelets, before maintenance and inspection work and use insulated tools for the work.)

\*) For P1-00044-L to P1-01240-L (P1-004L to P1-220L), P1-00041-H to P1-00620-H (P1-007H to P1-220H) models the wait time is 10 minutes.

For P1-01530-L to P1-02950-L (P1-300L to P1-550L), P1-00770-H to P1-03160-H (P1-300H to P1-1320H) models the wait time is 15 minutes.

#### 4.6. Precautions for disposal !

### ⚠ Danger

 ● **Risk of an injury and/or an explosion !**

· Outsource to a qualified industrial waste disposal contractor when discarding this device. Disposing of this device on your own may result in the production of poisonous gas

 Do

· Contact Hitachi technical service or your sales agent if you need to get this device fixed.

 · A qualified waste disposer includes industrial waste collector/transporter and industrial waste disposal operator. Follow all laws and decrees related to procedures of waste management and public cleansing when disposing of this device.

#### 4.7. Other Precautions

### ⚠ Danger

 ● **Risk of an injury, an electric shock and/or fire !**

· DO NOT modify this device

 Prohibited

※In addition to the precautions described above, there are other precautions described in the chapter 8 of the inverter user's guide. Please read and follow those precautions as well.

## 5. About the enclosed items

---

### · Enclosed items

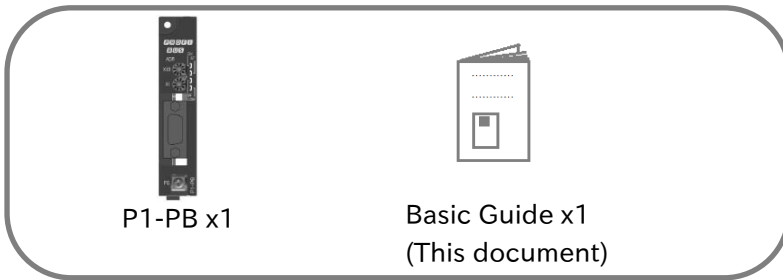

## 6. Verification after the purchase

---

- Please verify the following items when unpacking.
- In case there is any doubt or trouble with the product, please contact your sales agent as soon as possible.

✓ Check that the items were not smashed or damaged during the delivery

✓ Check that there is a P1-PB, there is a Basic Guide, when unpacking.

✓ Please check again that your order match with the name plate of the device

## 7. About Product Inquiry

---

For an inquiry about product damage or faults or a question about the product, notify your supplier or Hitachi inverter technical service office.

When contacting the technical service, please provide the following information

- (1) Inverter model,
- (2) Inverter manufacture number (MFG No.),
- (3) Option device model (P1-PB),
- (4) P1-PB manufacture number (MFG No.),
- (5) Date of purchase,
- (6) Inquiry contents,

For information about how to check the inverter model and the manufacture number (MFG No.) please refer to the inverter user's manual.

For information about how to check the P1-PB model and the manufacture number (MFG No.) please refer to the section 9.

Furthermore, if the inquiry is about a P1-PB communication problem please provide us with the following additional information.

- (7) Current problem or abnormality
- (8) Frequency of occurrence
- (9) The PROFIBUS master being used
- (10) The PROFIBUS network configuration
- (11) A communication log when the problem occurs (if possible)

For further information regarding the communication log please refer to the chapter 11 section 3 “P1-PB troubleshooting” of the User's Guide.



## 8. External Features

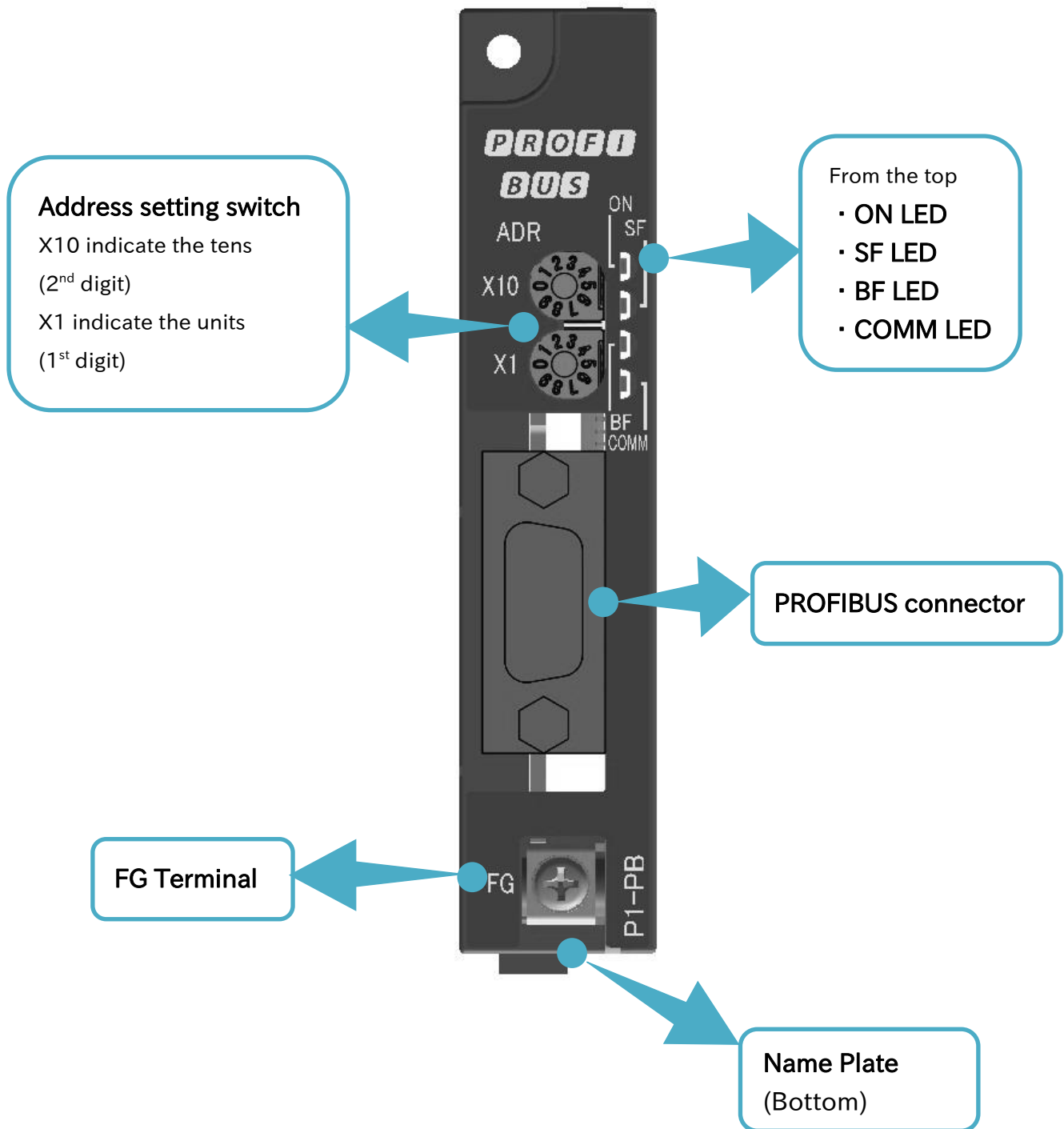

## 9. Name plate

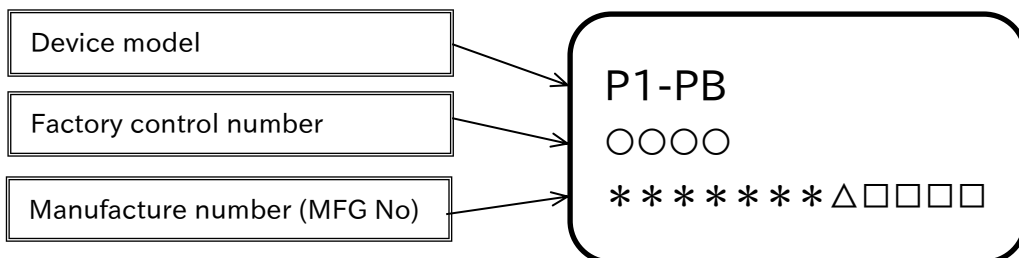

## 10. Supported inverters

The P1-PB can be attached to all types of SJ-P1. However, depending on the SJ-P1 manufacture date, it might not support the P1-PB. Please check the version of the inverter which is written on the name plate of it (the name plate example is shown on the image to the right). If the version is 2.00 or higher it can support the P1-PB

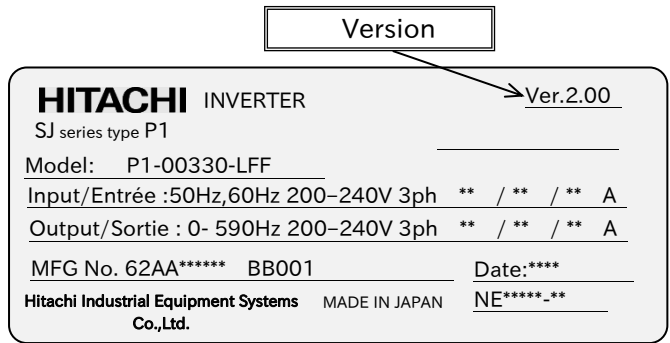

## 11. Installation

### 11.1. About the installation

The P1-PB can be attached to any of the 3 option slots of the SJ-P1 inverter.

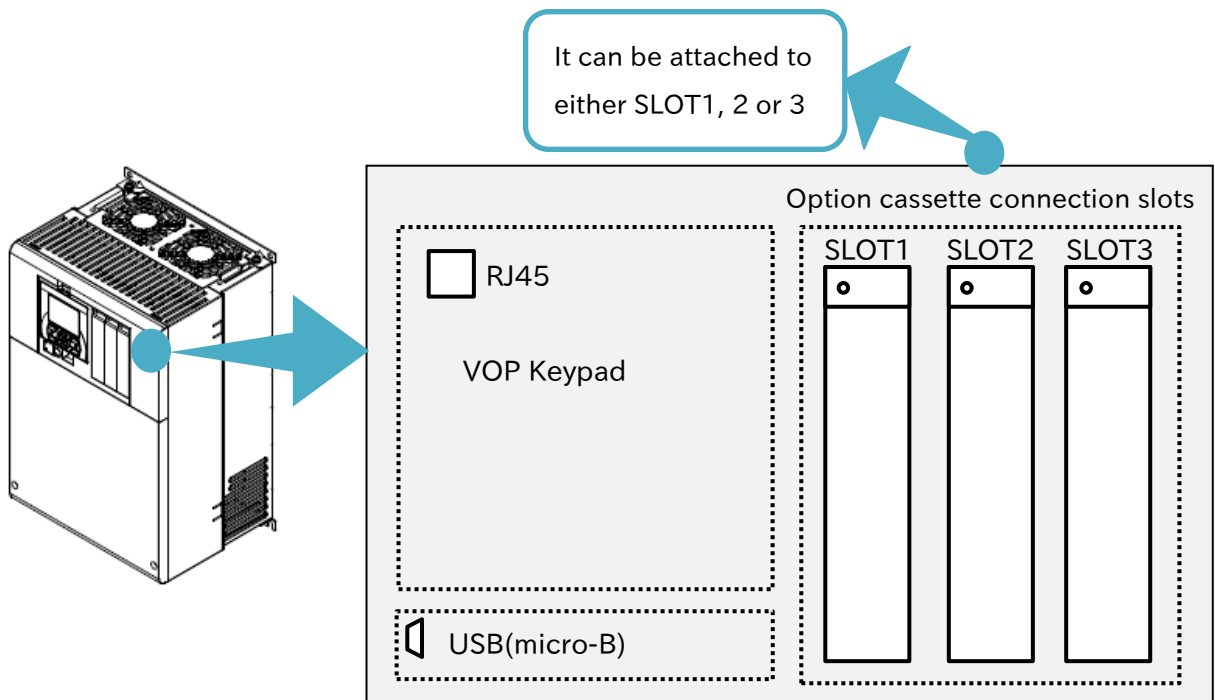

## 11.2. How to install

Before installing the P1-PB, please refer to the chapter 7 “Inverter Setting” of the user's guide and configure the inverter.

For explanation purposes, it will be assumed that the P1-PB is going to be installed in the SLOT1.

- (1) Remove the cover of the option cassette connection slot. Despite the removed cover will no longer be needed, it is recommended to keep it in a safe place. However the screw that secured the cover will be used to secure the P1-PB.

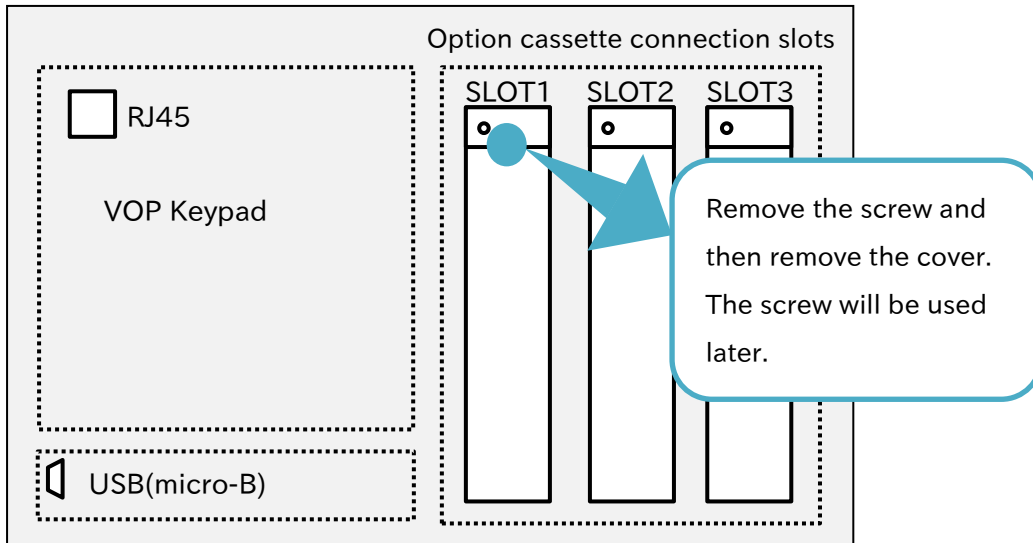

- (2) Attach the P1-PB. The slots 2 and 3 have one more connection in the lower side. However, the P1-PB will not need that connection.

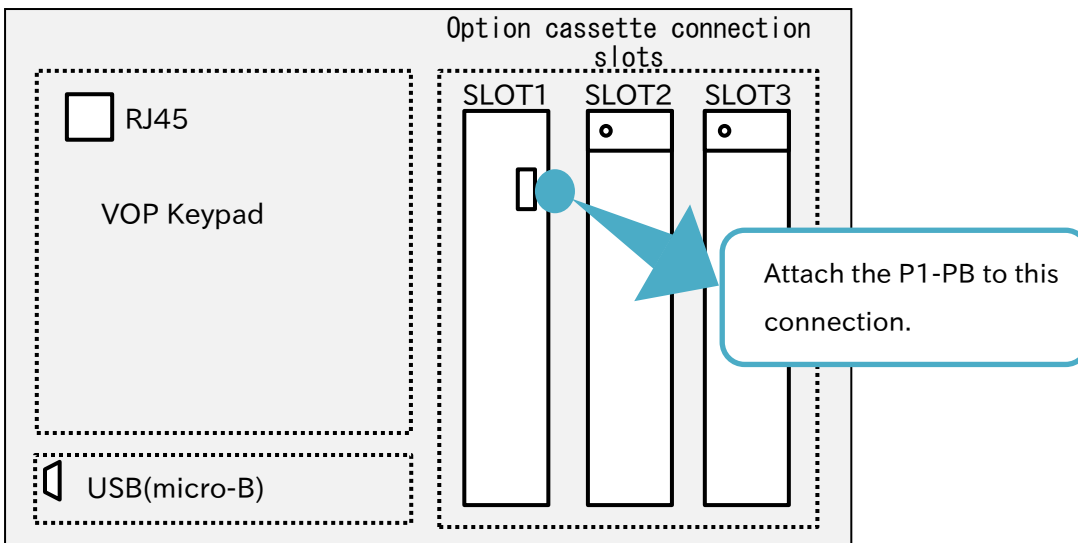

(3) Secure the P1-PB with the screw removed in (1)....

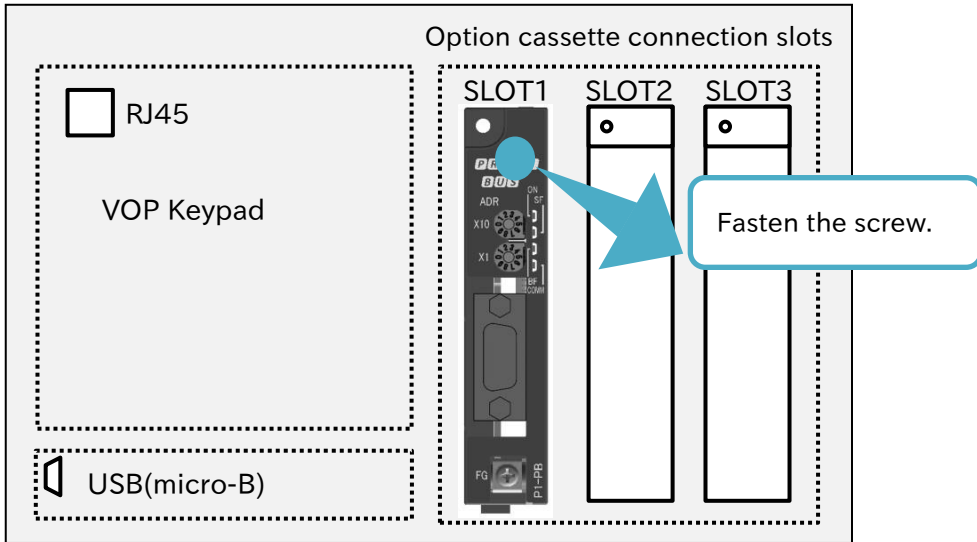

(4) Connect the FG terminal to functional ground.

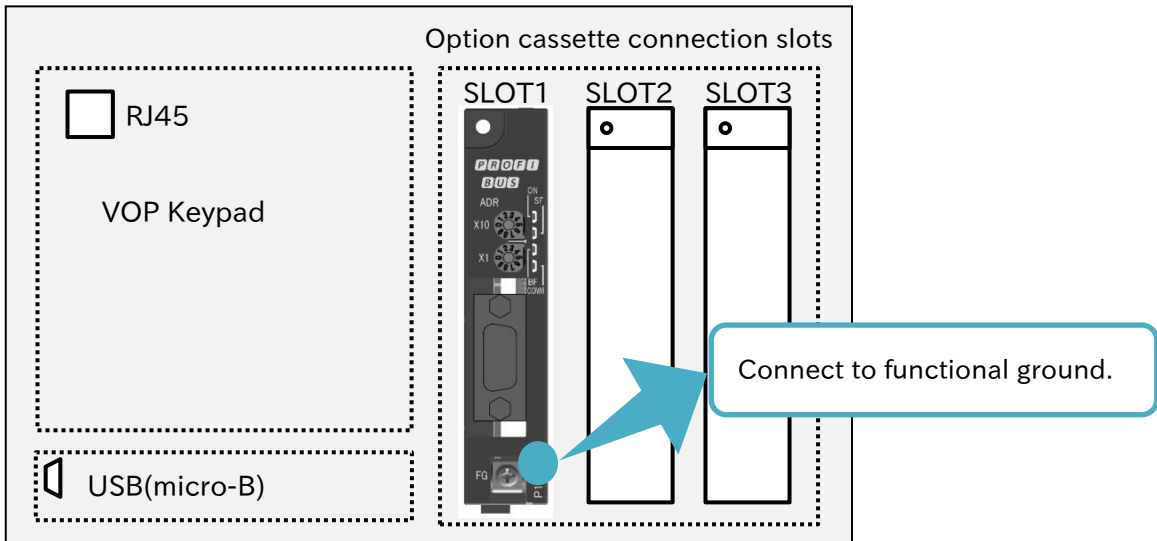

## 12. About the connection

---

- Make sure that the communication line and the power line are placed as far as possible from each other. If they are placed close to each other, the communication line will pick up noise from the power line that can interfere with the transmission.
- Make sure to set up the system, so that in an event of a network failure, the inverter output stops immediately.
  - (1) In case the master detects an abnormality in the connection, shut down the inverter primary power supply.
  - (2) Allocate functions such as “free run” or “reset” to the inverter input terminals. Accordingly, please turn on these terminals when the master detects a connection abnormality.
  - (3) Configure the inverter in a way that it stops, free run stops or trip in case of a connection abnormality. (When the operation command is received through PROFIBUS, the inverter shipment settings are configured so that if there is any abnormality in the connection the inverter will immediately stop)

For other information concerning the installation, please refer to the inverter user's guide.

Connect the communication cable (PROFIBUS cable), so it minimizes the tension and stress over the connector.

## 13. GSD File

---

In order to use the P1-PB, it is necessary to install the P1-PB GSD file into the PROFIBUS master Configuration tool. The GSD file is an xml file that has the specific information of the PROFIBUS slave device.

The GSD file can be obtained through our website. In case is not available or cannot be downloaded please contact the nearest sales office.

## 14. Device specifications

### ■ Specifications

Item		Specification	
Model		P1-PB	
Weight		170g	
Environment	Ambient operating temperature	-10~50°C	No icing or condensation conditions.
	Ambient operating humidity	20~90%RH	
	Storage temperature	-20~65°C	
	Vibration resistance	5.9m/s <sup>2</sup> (0.6G)、10~55Hz	
	Conformance to EMC and electrical safety standards	IEC/EN61800-3 Second environment, Category C3 IEC/EN61800-5-1 SELV	
	Enclosure type	IP00	
PROFIBUS Interface	Communications protocol	PROFIBUS DPV0 PROFIBUS DPV1	
	Connector	D-sub 9 pin	
	Cable	PROFIBUS DP cable	
	Node address *1)	From 0 to 99 : set by rotary switches From 1 to 126 : set by oH-20 of SJ-P1 paramters	
	Profile	PROFdrive	
PROFdrive	PROFdrive version	4.2	
	Application class	AC1 (Standard Drive)	
	Telegram	Standard telegram 1 P1-PB telegram 103 (PPO3 of PROFdrive version 2) P1-PB telegram 104 (PPO4 of PROFdrive version 2) P1-PB telegram 105 (like PPO5 of PROFdrive version 2)	
	Configuring of telegram	oH-24 and From oJ-01 to oJ-60 of SJ-P1 parameters	
	Operating mode	Speed control mode	
	Jogging	Only jogging 1 is supported.	

Note1: When you set the rotary switches within the range from 01 to 99, the value is addressed. When you set the rotary switches 00 and oH-20 is within the range from 1 to 125, the value of oH-20 is addressed. Otherwise 126 is addressed.

## 15. Dimensions after installed

The dimensions of the P1-PB after it is installed on the SJ-P1 are shown in the image below. As shown on the image a part of this device will stand out from the SJ-P1. Please be cautious when installing the device.

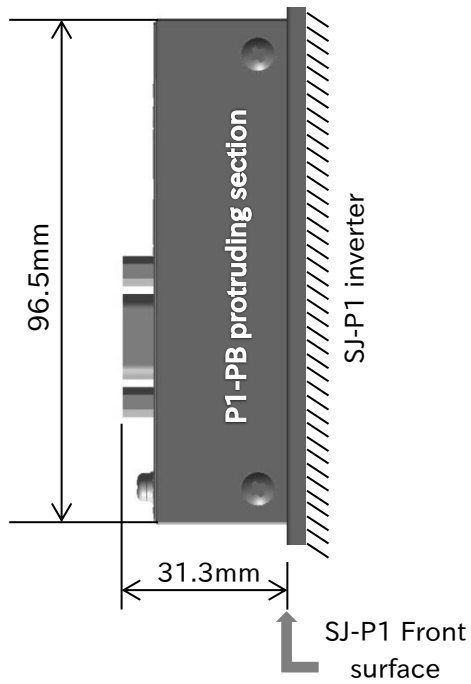

View from the right side of the SJ-P1

## 16. Registered Trademark

PROFIBUS® is trade names of the non-profit organization PROFIBUS Nutzerorganisation e.V.(PNO).

(Memo)