

# H Series PLC **HITACHI**

EH-150 Analog input module  
EH-AXH8M Instruction manual

Thank you for purchasing a Hitachi Programmable Logic Controller. To operate it safely, please read this instruction manual and all the user manuals carefully. Please be sure to use the latest versions of user manuals and keep them at hand of end users for future reference.

**Caution**

1. All rights reserved.
2. The content of this manual may be changed without notice.
3. While efforts have been made on this manual to be accurate, please contact us if any mistakes or unclear part is found.

## ■ Warranty period and coverage

The warranty period is either 18 months after manufacturing date (MFG No) or 12 months after installation. Examination and repair within the warranty period is covered.

However within the warranty period, the warranty will be void if the fault is due to;

- (1) Incorrect use from instructed in this manual and the application manual.
- (2) Malfunction or failure of external other devices than this unit.
- (3) Attempted repair by unauthorized personnel.
- (4) Natural disasters.

The warranty is for the PLC only, any damage caused to third party equipment by malfunction of the PLC is not covered by the warranty.

## ■ Repair

Any examination or repair after the warranty period is not covered. And within the warranty period any repair and examination which results in information showing the fault was caused by any of the items mentioned above, the repair and examination cost are not covered. If you have any questions regarding the warranty or repair cost, please contact your supplier or the local Hitachi Distributor. (Depending on failure part, repair might be impossible.)

## ■ Ordering spare parts and inquiries

Please contact your local suppliers for ordering products/spare parts or any inquiries with providing the following information.

- (1) Product name
- (2) Manufacturing number (MFG No.)
- (3) Details of failure

## Safety precautions

### ■ Definitions and Symbols



**DANGER**

Indicates a potentially hazardous situation which, if not avoided, can result in serious injury or death.



**CAUTION**

Indicates a potentially hazardous situation which, if not avoided, can result in minor to moderate injury, or serious damage of product.





: Indicates prohibition



: Indicates Compulsion

 <b>DANGER</b>
<ul style="list-style-type: none"> <li>- Do not touch terminals while power ON. There is a danger of electric shock and/or injury.</li> <li>- Be sure to install external safety devices outside of the PLC like emergency stop circuit or interlock circuit.</li> </ul>

 <b>CAUTION</b>
<ul style="list-style-type: none"> <li>- Be sure that the rated voltage matches the power supply voltage of the unit. Otherwise, there is a danger of breakdown and/or injury and/or fire.</li> <li>- Only qualified personnel shall carry out wiring work. Otherwise, there is a danger of breakdown and/or injury and/or fire.</li> </ul>

 <b>COMPULSION</b>
<ul style="list-style-type: none"> <li>- Be sure to ground the unit. Otherwise, there is a danger of electric shock and/or malfunction.</li> </ul>

 <b>PROHIBITION</b>
<ul style="list-style-type: none"> <li>- Do not attempt to modify nor disassemble the unit. There is a danger of breakdown and/or injury and/or fire.</li> </ul>

### ■ Mounting

- Mount the PLC on a metal plate and install in a cabinet as follows.
- Be sure to ground the cabinet and the metal plate, otherwise there is a risk of malfunction.
- Install the PLC as described in user manual.
- Take appropriate measures when the PLC system installed in locations :
  - Influenced easily due to noise or static electricity or other forms of noise.
  - Under strong electromagnetic field.
  - Close to power supplies.
- Be sure to tighten mounting screws, terminal screws and connector screws.
- Be sure to check that devices with lock mechanism, such as an expansion cable or terminal blocks, are locked properly.

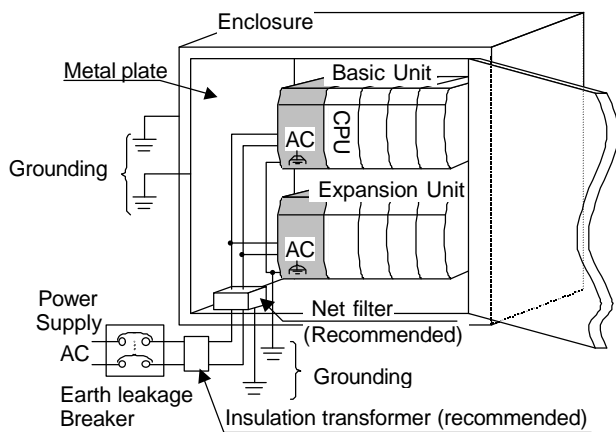

Figure 1 Power wiring example

Table1 Specifications of the net filter

Item		Spec.
Rated voltage		250 VAC
Rated current		5 A
Withstand voltage (V) (between Terminal and case)		1500 V
Insulation resistance (M $\Omega$ ) (500VDC, 1 min., between terminal and case)		min. 100 M
Attenuation Frequency range (MHz)	Differential mode, more than 40dB	0.5 - 30
	Common mode, more than 40dB	0.15 - 30

Reference : EMC filter ZAC2205-00U (TDK)

## ■ Power Wiring

- Appropriate emergency circuitry, interlock circuitry and similar safety measures should be added to the system.
- Appropriate safety measures should be included in the system for unexpected breaking of wire or malsignal caused from instantaneous power failure.
- Applied voltage must be in the range specified in the manual. Otherwise, there is a danger of breakdown and/or injury and/or fire.
- Install an external earth leakage breakers to avoid short circuit accident.
- In case of the following operations, turn off power. Otherwise, there is a danger of breakdown and/or injury and/or fire.
  - Mounting or dismounting CPU and I/O modules.
  - Assembling cabinet or machine including PLC.
  - Wiring.
- Install net filter specified in table-1 or similar. The input and output cable of the net filter should be separated as much as possible. Be sure to ground the net filter.
- A shielded and insulated transformer is recommended.
- The basic and expansion unit should be connected to common power source and powered up together as shown in fig.1.

## ■ I/O Wiring

- Be sure that the input/output voltage matches the specified voltage. Otherwise, there is a danger of breakdown and/or fire.
- Use shielded cable for relay outputs module, and connect shields to a functional ground for one side or both sides depending on applications.
- Route the AC power line and I/O lines separated as much as possible. Do not route both cables in a same duct.
- Route the I/O lines and data lines as close as possible to the grounded surfaces such as cabinet elements, metal bars and cabinets panels.

## ■ Common precautions

- Use proper cable ferrules for terminals. Using improper cable ferrules or connecting bare wires to terminals directly might result in fire.
- Do not turn on power, if the unit appears damaged.
- Be sure to check all the field wiring before PLC power on. Otherwise, there is a risk of fire.
- Do not attempt to disassemble, repair or modify any part of the PLC.
- Do not pull on cables or bend cables beyond their natural limit. Otherwise, there is a risk of breaking of wire.
- Keep PLC modules in their boxes during storage and transport.
- Check carefully your PLC program before operation.

## Installation environment

- Avoid the following locations to install the PLC.
- Excessive dusts, salty air, or conductive materials (iron powder, etc.)
  - Direct sunlight.
  - Temperature less than 0°C or more than 55°C.
  - Humidity less than 20% or more than 90%.
  - Dew condensation.
  - Direct vibration or impact to the unit.
  - Corrosive, explosive or combustible gases.
  - Water, chemicals or oil splashing on the PLC.
  - Close to noise emission devices.

## ■ Reference Manual

Read the following application manual carefully to use the PLC safely and properly. Be sure to keep the latest version.

Manual name	Manual No.
EH-150 APPLICATION MANUAL	NJI-281* (X)

\* : The alphabet between 281 and (X) means version (A,B...).

# 1 Name and function

	Type	EH-AXH8M
	Weight	Approx. 150 g
	Dimension (mm)	

No.	Name	Function	Remarks
1]	Lock button	When dismantling the module from a base unit, press this button and lift up the module. The module can be fixed firmly by a screw (M4, 10 mm (0.39 in.))	
2]	I/O cover	This is the cover attached to the terminal block	
3]	Terminal block	This is the terminal block for connecting input signals. The terminal block is removable.	
4]	Function switch	To configure input range, enable/disable of input filter and resolution.	Refer to 4.Setting switch.
5]	Current / voltage switch	To configure current or voltage input.	Refer to 4.Setting switch.
6]	LED cover	Status of module and input signal indicated. OK LED lights in normal operation. Input LED blinks when input current is less than 2mA in case of 4 - 22mA range. (Mode 10)	For wire breaking detection

Item	Description	Remarks
Operation	The module receives input signals from external devices. The CPU module recognizes the status of the loaded module and when it matches the I/O assignment information included in the user program, input information is received according to the contents of the user program.	
Terminal block	<p>The screws for the terminal block are M3 screws. Use a crimp terminal that fits the screw diameter. The maximum thickness of the cable should be only up to 0.75 mm<sup>2</sup>. (Use 0.5 mm<sup>2</sup> cable when two crimp terminals are attached to the same terminal.)</p> <p>The recommended crimp terminal is indicated below.</p> <p>Unit: mm (in.)</p>	

## 2 Specification

### Function specification

item		Specification
Model name		EH-AXH8M
Input range  (Selected by the switch.)	Voltage input	0 to 10 V DC
		-10 to 10 V DC
	Current input	0 to 22 mA
		4 to 22 mA
Resolution  (Selected by the switch)	0 to 10 V	1 mV or 1/16384 (14 bits)
	-10 to 10 V	1 mV or 1/16384 (14 bits)
	0 to 22 mA	0.002 mA or 1/16384 (14 bits)
	4 to 22 mA	0.002 mA or 1/16384 (14 bits)
Conversion time		8.9 ms / 8 channels
Overall accuracy	Voltage input	±0.5 % or less (Full scale)
	Current input	±0.8 % or less (Full scale)
Linearity		±0.1 % or less (Full scale)
Input filter  (Selected by the switch)	Enable	Approx. 90 ms (to reach 90% after step input)
	Disable	18 ms or less (to reach 90% after step input)
Input impedance	Voltage input	Differential 200 kΩ
	Current input	249 Ω
Isolation	Between channel and internal bus	Photo coupler
	Between channels	Not isolated
Number of input channel		Differential voltage input 8 ch. or Current input 8 ch. (selected per 4 ch.)
Weight		Approx. 0.15 kg
Wiring		Removable terminal block (M3)
Internal current consumption (5VDC)		Max. 70mA
External power supply		24 V DC (+20 %, -15 %) Approx. 0.04 A (Approx. 0.3 A at power on)
Cable		Shielded pair cable (Max. 20m)
I/O assignment		X8W
Operational temperature / humidity		0 - 55 °C / 20 - 90%RH (no condensation)
Storage temperature / humidity		-10 - 75 °C / 10 - 90%RH (no condensation)

### 3 Terminal layout and internal circuit

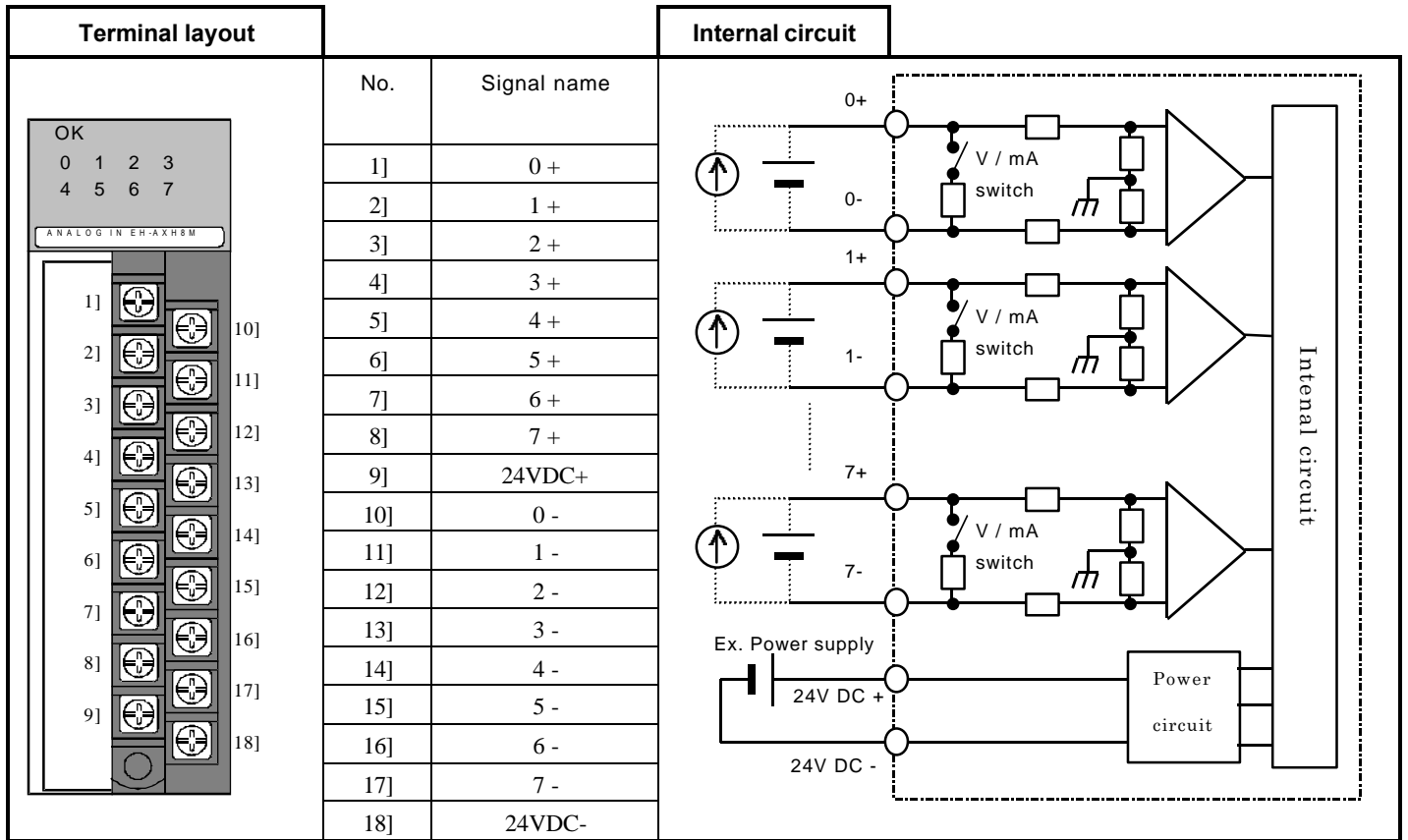

## 4 Setting switch

Be sure to configure the module before operation without power supplied. Switch setting is not effective while power on. If input range is changed, be sure to set current/voltage switch accordingly. [Black part is factory setting.]

Table 4.1 Function switch

Switch No.	Setting		Function
	1	2	
1, 2			Input range for ch.0 to 3
	OFF	OFF	0 to 10 V DC
	ON	OFF	-10 to 10 V DC
	OFF	ON	0 to 22 mA
	ON	ON	4 to 22 mA
3, 4			Input range for ch.4 to 7
	OFF	OFF	0 to 10 V DC
	ON	OFF	-10 to 10 V DC
	OFF	ON	0 to 22 mA
	ON	ON	4 to 22 mA
5	5		Input filter
	OFF		Eable
	ON		Disable
6	6		Resolution mode
	OFF		[Mode 16] Hexa-decimal (1/16384)
	ON		[Mode 10] Decimal (0.001V or 0.002mA)
7	7		For system use
	OFF		Set OFF
8	8		For system use
	OFF		Set OFF

Table 4.2 Voltage/current switch

Switch No.	Setting		Function
	1 to 4	5 to 8	
1 to 8			Current / voltage selecting
	OFF	OFF	Ch.0 to 7 : Voltage input
	ON	OFF	Ch. 0 to 3 : Current input, Ch.4 to 7 : Voltage input
	OFF	ON	Ch. 0 to 3 : Voltage input, Ch.4 to 7 : Current input
	ON	ON	Ch.0 to 7 : Current input

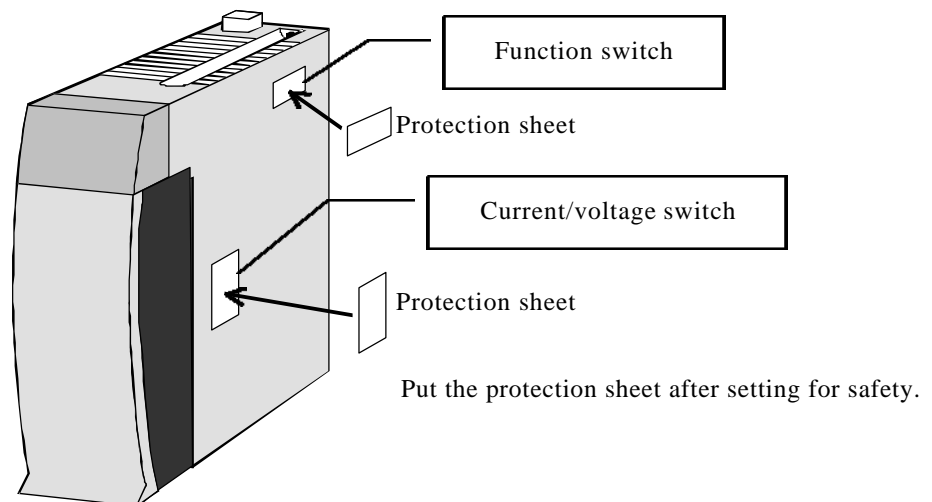

## 5 Input conversion

### 0 to 10V

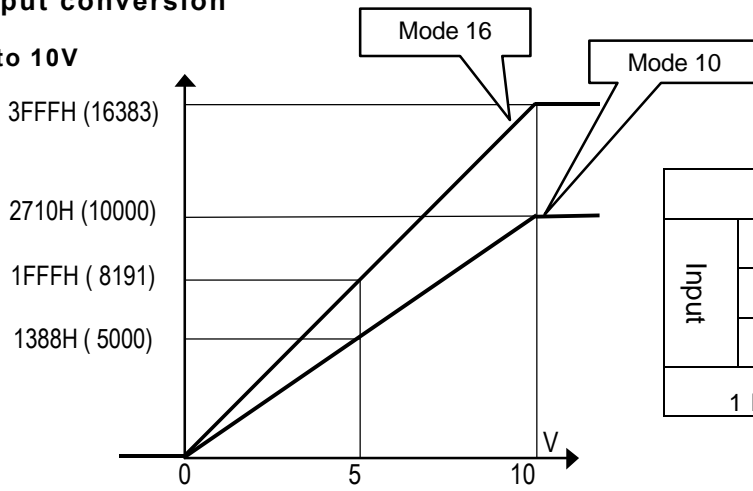

		Mode 10		Mode 16	
Input	10 V	10000	2710H	16383	3FFFH
	5 V	5000	1388H	8191	1FFFH
	0 V	0	0000H	0	0000H
1 bit		1 mV		0.61035 mV	

### ± 10V

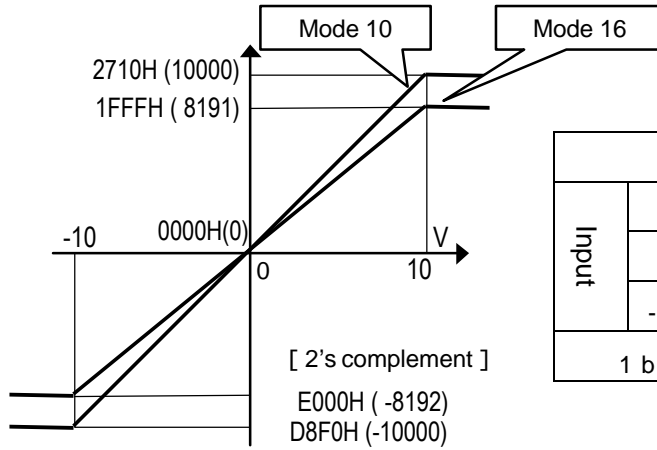

		Mode 10		Mode 16	
Input	10 V	10000	2710H	8191	1FFFH
	0 V	0	0000H	0	0000H
	-10 V	-10000	D8F0H	-8192	E000H
1 bit		1 mV		1.22070 mV	

### 0 to 22 mA

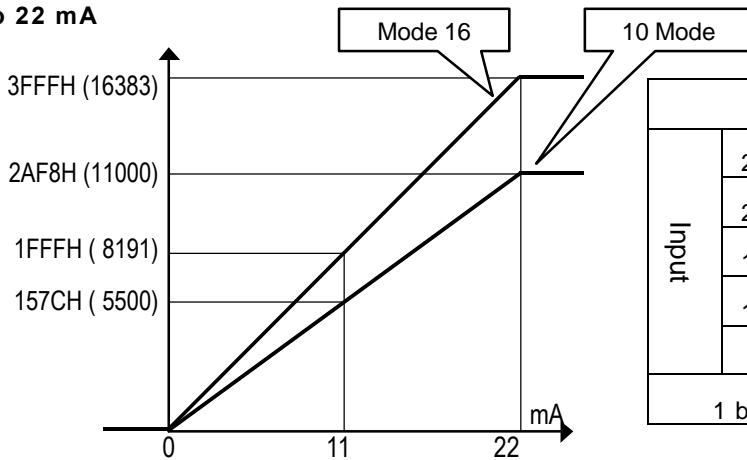

		Mode 10		Mode 16	
Input	22mA	11000	2AF8H	16383	3FFFH
	20mA	10000	2710H	14894	3A2EH
	11mA	5500	157CH	8191	1FFFH
	10mA	5000	1388H	7447	1D17H
	0mA	0	0000H	0	0000H
1 bit		2 μA		1.34277 μA	

### 4 to 22 mA

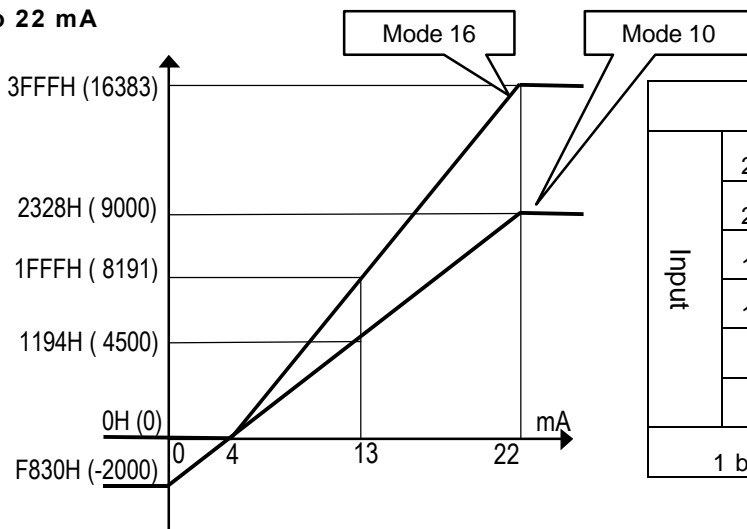

		Mode 10		Mode 16	
Input	22mA	9000	2328H	16383	3FFFH
	20mA	8000	1F40H	14563	38E3H
	13mA	4500	1194H	8191	1FFFH
	10mA	3000	0FA0H	4468	1174H
	4mA	0	0000H	0	0000H
	0mA	-2000	F830H	0	0000H
1 bit		2 μA		1.09863 μA	

## 6 Caution

### (1) Input signal out of the range

Input signal out of the range is converted to the max. or min. value as follows.

Ex. : -11V input for  $\pm 10\text{V}$  range.  $\rightarrow$  -10000 (Mode 10), E000H (Mode 16)

Ex. : 23mA input for 0-22mA range.  $\rightarrow$  11000 (Mode 10), 3FFFH (Mode 16)

Ex. : 1mA input for 4-22mA range.  $\rightarrow$  -1500 (Mode 10), 0000H (Mode 16)

### (2) LED indication

LED	Lighting	Blinking	off
OK	Normal operation *	Module error. (Contact your local supplier if it happens frequently.)	- No power supplied - Module error (Contact your local supplier if it happens frequently.)
0 to 7	-	Wire breaking (2mA input or less in case of 4-22mA range (Mode 10) )	Normal operation

\* OK LED lights without external DC24V.

### (3) Wiring

Since analog signal is very sensitive, be sure to use shielded cable in order to protect from noise, and route the cable apart from other power/signal cables.

Be sure to ground the shield at one end basically. But grounding at both ends or no grounding can be more effective depending on system environment.

