

Analog Input Module (Voltage)

RIO3-AX... User Manual

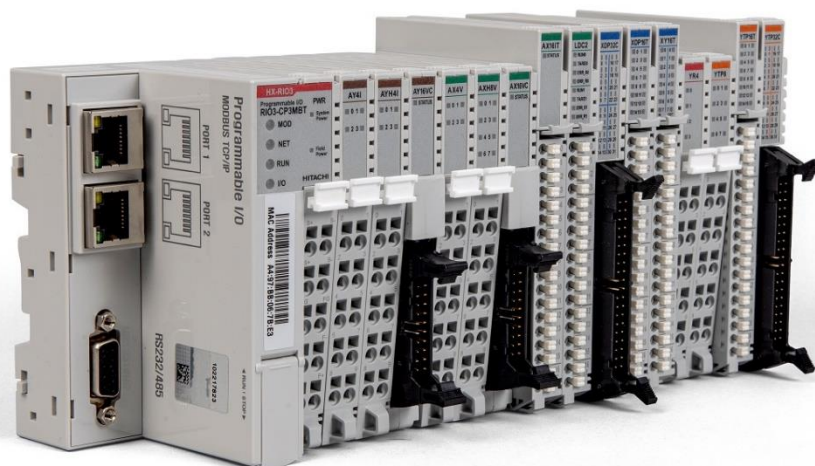

Version 1.02

REVISION HISTORY				
REV	PAGE	REMARKS	DATE	EDITOR
1.02		New Document	05 NOV 2020	(OPR), (PF)

Table of Contents

1	Important Notes	5
1.1	Safety Instruction	6
1.1.1	Symbols	6
1.1.2	Safety Notes	6
1.1.3	Certification	6
2	Analog Input Module List.....	7
3	Specification	8
3.1	RIO3-AX4V	8
3.1.1	Wiring Diagram	8
3.1.2	LED Indicator	9
3.1.3	Channel Status LED	9
3.1.4	Environment Specification	10
3.1.5	Specification.....	11
3.1.6	Data Value / Voltage	12
3.1.7	Mapping Data into the Image Table.....	14
3.1.8	Parameter Data.....	14
3.2	RIO3-AXH4V	15
3.2.1	Wiring Diagram	15
3.2.2	LED Indicator	16
3.2.3	Channel Status LED	16
3.2.4	Environment Specification	17
3.2.5	Specification.....	18
3.2.6	Data Value / Voltage	19
3.2.7	Mapping Data into the Image Table.....	21
3.2.8	Parameter Data.....	21
3.3	RIO3-AX8V	22
3.3.1	Wiring Diagram	22
3.3.2	LED Indicator	23
3.3.3	Channel Status LED	23
3.3.4	Environment Specification	24
3.3.5	Specification.....	25
3.3.6	Data Value / Voltage	26
3.3.7	Mapping Data into the Image Table.....	28
3.3.8	Parameter Data.....	29
3.4	RIO3-AXH8V	30
3.4.1	Wiring Diagram	30
3.4.2	LED Indicator	31
3.4.3	Channel Status LED	31
3.4.4	Environment Specification	32
3.4.5	Specification.....	33
3.4.6	Data Value / Voltage	34
3.4.7	Mapping Data into the Image Table.....	36
3.4.8	Parameter Data.....	37
3.5	RIO3-AX16VC	38
3.5.1	Wiring Diagram	38
3.5.2	LED Indicator	39
3.5.3	Channel Status LED	39
3.5.4	Environment Specification	40

3.5.5	Specification.....	41
3.5.6	Data Value / Voltage	42
3.5.7	Mapping Data into the Image Table.....	44
3.5.8	Parameter Data.....	46
3.6	RIO3-AX16VT	47
3.6.1	Wiring Diagram	47
3.6.2	LED Indicator	48
3.6.3	Channel Status LED	48
3.6.4	Environment Specification	49
3.6.5	Specification.....	50
3.6.6	Data Value / Voltage	51
3.6.7	Mapping Data into the Image Table.....	53
3.6.8	Parameter Data.....	55
4	Dimension.....	56
4.1	10-Pts. Spring Type	56
4.2	20-Pin Connector Type	57
4.3	18-Pts. Spring Type	58
5	Mounting.....	59
5.1	I/O Inserting and Removing Devices	59
5.2	RTB (Removable Terminal Block)	60
6	Bus Pin Description	61
7	APPENDIX	62
7.1	Product List.....	62
7.2	Glossary.....	63

1 Important Notes

Solid state equipment has operational characteristics differing from those of electromechanical equipment.

Safety Guidelines for the Application, Installation and Maintenance of Solid-State Controls describes some important differences between solid state equipment and hard-wired electromechanical devices.

Because of this difference, and because of the wide variety of uses for solid state equipment, all persons responsible for applying this equipment must satisfy themselves that each intended application of this equipment is acceptable.

In no event will HITACHI be responsible or liable for indirect or consequential damages resulting from the use or application of this equipment.

The examples and diagrams in this manual are included solely for illustrative purposes. Because of the many variables and requirements associated with any installation, HITACHI cannot assume responsibility or liability for actual use based on the examples and diagrams.

Warning!



- ✓ **If you don't follow the directions, it could cause a personal injury, damage to the equipment or explosion.**
- ✓ Do not assemble the products and wire with power applied to the system. Else it may cause an electric arc, which can result into unexpected and potentially dangerous action by field devices. Arching is explosion risk in hazardous locations. Be sure that the area is non-hazardous or remove system power appropriately before assembling or wiring the modules.
- ✓ Do not touch any terminal blocks or IO modules when system is running. Else it may cause the unit to an electric shock or malfunction.
- ✓ Keep away from the strange metallic materials not related to the unit and wiring works should be controlled by the electric expert engineer. Else it may cause the unit to a fire, electric shock or malfunction.

Caution!

- ✓ **If you disobey the instructions, there may be possibility of personal injury, damage to equipment or explosion. Please follow below Instructions.**
- ✓ Check the rated voltage and terminal array before wiring. Avoid the circumstances over 50°C of temperature. Avoid placing it directly in the sunlight.
- ✓ Avoid the place under circumstances over 85% of humidity.
- ✓ Do not place Modules near by the inflammable material. Else it may cause a fire.
- ✓ Do not permit any vibration approaching it directly.
- ✓ Go through module specification carefully, ensure inputs, output connections are made with the specifications. Use standard cables for wiring.
- ✓ Use Product under pollution degree 2 environment.

1.1 Safety Instruction

1.1.1 Symbols

<p>DANGER</p> 	<p>Identifies information about practices or circumstances that can cause an explosion in a hazardous environment, which may lead to personal injury or death property damage, or economic loss.</p>
<p>IMPORTANT</p>	<p>Identifies information that is critical for successful application and understanding of the product.</p>
<p>ATTENTION</p> 	<p>Identifies information about practices or circumstances that can lead to personal injury, property damage, or economic loss.</p> <p>Attentions help you to identify a hazard, avoid a hazard, and recognize the Consequences.</p>

1.1.2 Safety Notes

<p>DANGER</p> 	<p>The modules are equipped with electronic components that may be destroyed by electrostatic discharge. When handling the modules, ensure that the environment (persons, workplace and packing) is well grounded. Avoid touching conductive components, G-BUS Pin.</p>
--	---

1.1.3 Certification

UL Listed Industrial Control Equipment, certified for U.S.

See UL File E196687

CE Certificate

EN 61000-6-2; Industrial Immunity

EN 61000-6-4; Industrial Emissions

Reach, RoHS (EU, CHINA), EAC

2 Analog Input Module List

RIO3-Number	Description	ID
RIO3-AX4V	Analog Input, 4 Channels, 0~10, 0~5, 1~5 Vdc, 12Bits, 10RTB	3424
RIO3-AXH4V	Analog Input, 4 Channels, 0~10, 0~5, 1~5 Vdc, 16Bits, 10RTB	3464
RIO3-AX8V	Analog Input, 8 Channels, 0~10, 0~5, 1~5 Vdc, 12Bits, 10RTB	3428
RIO3-AXH8V	Analog Input, 8 Channels, 0~10, 0~5, 1~5 Vdc, 16Bits, 10RTB	3468
RIO3-AX16VC	Analog Input, 16 Channels, 0~10, 0~5, 1~5 Vdc, 12Bits, 20P Connector	342F
RIO3-AX16VT	Analog Input, 16 Channels, 0~10, 0~5, 1~5 Vdc, 12Bits, 18RTB	347F

3 Specification

3.1 RIO3-AX4V

3.1.1 Wiring Diagram

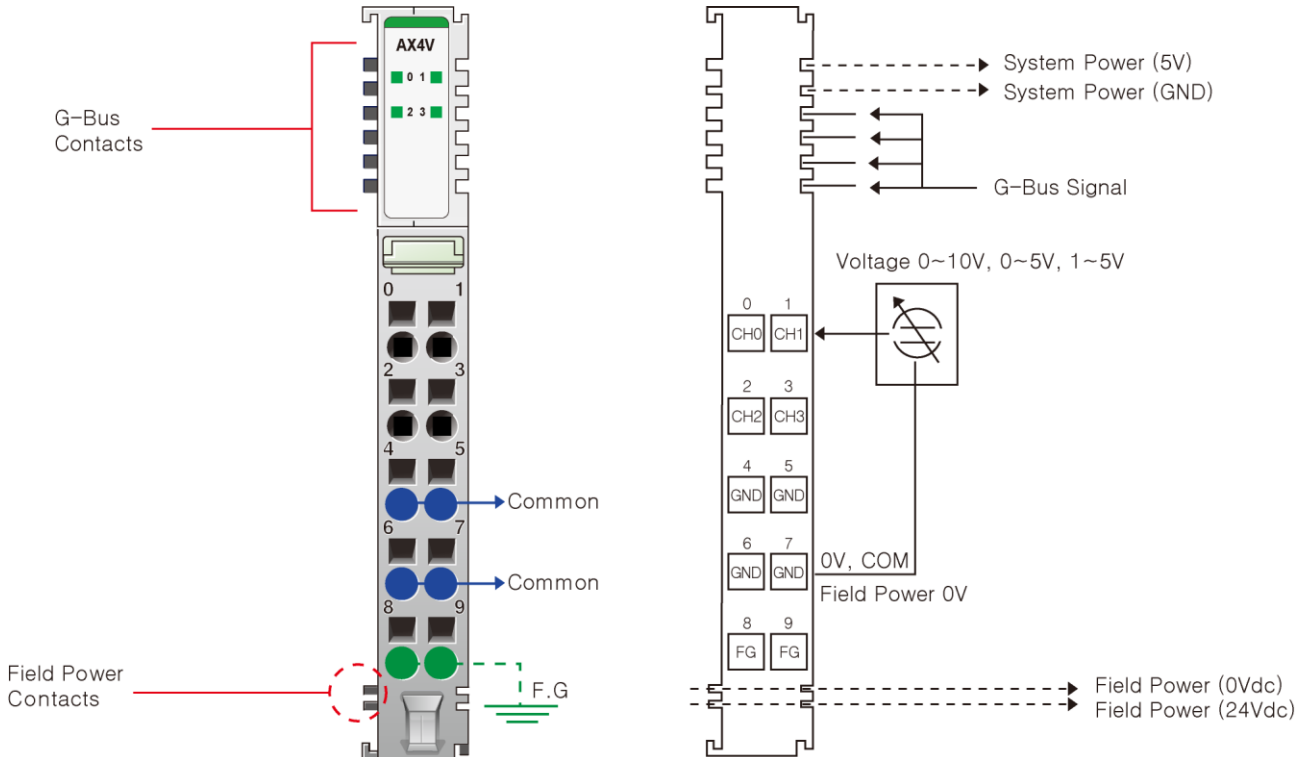

Pin No.	Signal Description	Signal Description	Pin No.
0	Input Channel 0	Input Channel 1	1
2	Input Channel 2	Input Channel 3	3
4	Input Channel Common (AGND)	Input Channel Common (AGND)	5
6	Input Channel Common (AGND)	Input Channel Common (AGND)	7
8	F.G	F.G	9

3.1.2 LED Indicator

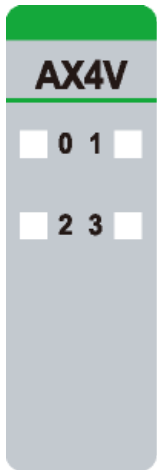

LED No.	LED Function / Description	LED Color
0	Input Channel 0	Green
1	Input Channel 1	Green
2	Input Channel 2	Green
3	Input Channel 3	Green

3.1.3 Channel Status LED

Status	LED	To indicate
Normal Operation	[LED Off < 0.5% (Maximum Input Value)] - Channel OFF [LED On > 0.5% (Maximum Input Value)] - Channel Green	Normal Operation
Field Power Error	All Channel Repeat the Green and Off	Field Power is unconnected

3.1.4 Environment Specification

Environmental Specification	
Operation Temperature	-40°C ~ 70°C
UL Temperature	-20°C ~ 60°C
Storage Temperature	-40°C ~ 85°C
Relative Humidity	5% ~ 90% Non-condensing
Mounting	DIN Rail
General Specification	
Shock Operating	IEC 60068-2-27
Vibration Resistance	Based on IEC 60068-2-6 DNVGL-CG-0039: Vibration Class B, 4g
Industrial Emissions	EN61000-6-4: 2007 +A1: 2011
Industrial Immunity	EN61000-6-2: 2005
Installation Position	Vertical and horizontal installation is possible
Product Certifications	CE, UL, EAC

3.1.5 Specification

Items	Specification
Input Specification	
Inputs Per Module	4 Channels Single Ended, Non-Isolated Between Channel
Indicators (Logic side)	4 Green Input Status
Resolution in Ranges	12 bits: 2.44mV / Bit (0~10V), 1.22mV / Bit (0~5V) 0.977mV/Bit (1~5V)
Input Current Ranges	0 ~ 10Vdc, 0 ~ 5Vdc, 1 ~ 5Vdc
Data Format	16 Bits Integer (2' complement)
Module Error	±0.1% Full Scale @ 25°C ambient ±0.3% Full Scale @ -40°C, 70°C
Input Impedance	500 kΩ
Diagnostic	Diagnostic Field Power Off: LED Blinking Field Power On: LED Off < 0.5% (Maximum Input Value) Field Power On: LED On > 0.5% (Maximum Input Value)
Conversion Time	0.4msec / All Channels
Field Calibration	Not Required
Common Type	4 Common, Field Power 0V is Common (AGND)
General Specification	
Power Dissipation	Max. 25mA @ 5.0Vdc
Isolation	I/O to Logic: Isolation Field Power: Non-Isolation
UL Field Power	Supply Voltage: 24Vdc nominal, Class 2
Field Power	Supply Voltage: 24Vdc nominal Voltage Range: 18 ~ 30Vdc Power Dissipation: Max. 25mA @ 24Vdc
Wiring	I/O Cable Max. 2.0mm ² (AWG 14)
Torque	0.8Nm (7lb-in)
Weight	58g
Module Size	12mm x 99mm x 70mm
Environment Condition	Refer to 'Environment Specification'

3.1.6 Data Value / Voltage

Voltage Range: 0 ~ 10Vdc

Voltage	0.0V	2.5V	5.0V	10.0V
Data (Hex)	H0000	H03FF	H07FF	H0FFF

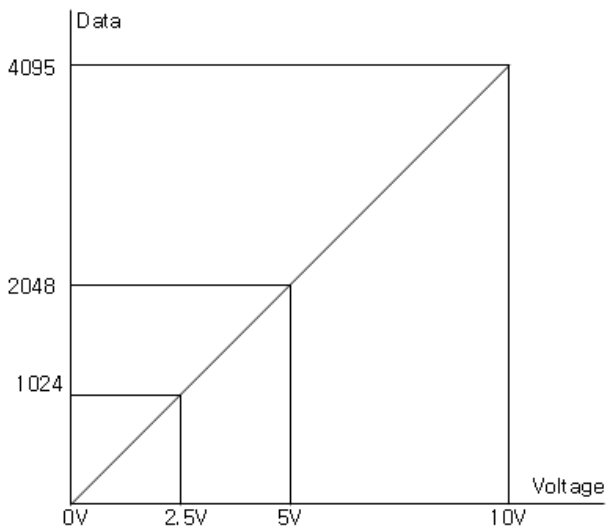

Voltage Range: 0 ~ 5Vdc

Voltage	0.0V	1.25V	2.5V	5.0V
Data (Hex)	H0000	H03FF	H07FF	H0FFF

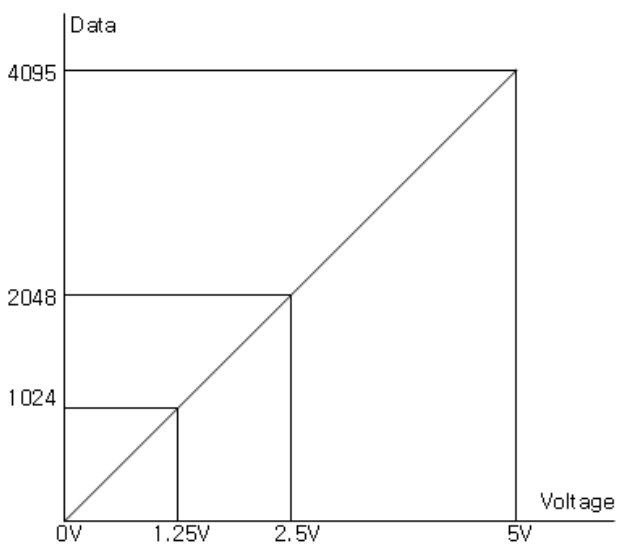

Voltage Range: 1 ~ 5Vdc

Voltage	1.0V	2.0V	3.0V	5.0V
Data (Hex)	H0000	H03FF	H07FF	H0FFF

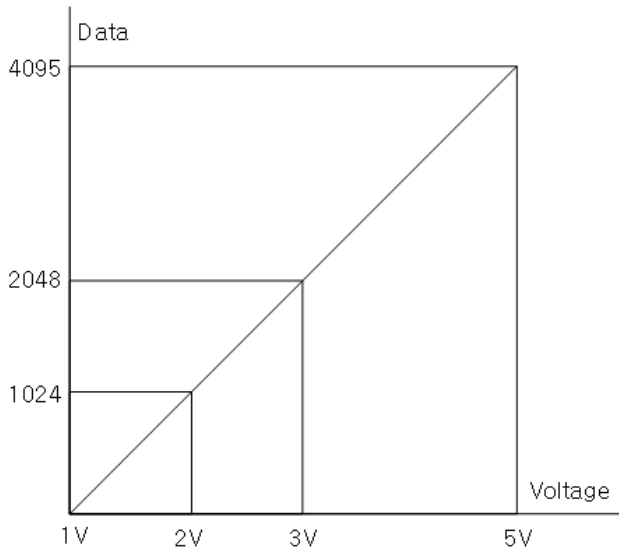

3.1.7 Mapping Data into the Image Table.

Input Module Data

Analog Input Ch0
Analog Input Ch1
Analog Input Ch2
Analog Input Ch3

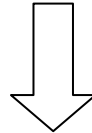

Input Image Value

Bit No	Bit7	Bit6	Bit5	Bit4	Bit3	Bit2	Bit1	Bit0
Byte 0	Analog Input Ch0 Low byte							
Byte 1	Analog Input Ch0 High byte							
Byte 2	Analog Input Ch1 Low byte							
Byte 3	Analog Input Ch1 High byte							
Byte 4	Analog Input Ch2 Low byte							
Byte 5	Analog Input Ch2 High byte							
Byte 6	Analog Input Ch3 Low byte							
Byte 7	Analog Input Ch3 High byte							

3.1.8 Parameter Data

Valid Parameter length: 6 Bytes

Parameter Data

Bit No	Bit7	Bit6	Bit5	Bit4	Bit3	Bit2	Bit1	Bit0
Byte 0	Voltage Range for Channel 0 (H00: 0~10Vdc, H01: 0~5Vdc, H02: 1~5Vdc)							
Byte 1	Voltage Range for Channel 1 (H00: 0~10Vdc, H01: 0~5Vdc, H02: 1~5Vdc)							
Byte 2	Voltage Range for Channel 2 (H00: 0~10Vdc, H01: 0~5Vdc, H02: 1~5Vdc)							
Byte 3	Voltage Range for Channel 3 (H00: 0~10Vdc, H01: 0~5Vdc, H02: 1~5Vdc)							
Byte 4	Filter Time (H00: Default Filter (20) / H01: Fastest ~ / H3E: Slowest)							
Byte 5	Not used (=00)							

3.2 RIO3-AXH4V

3.2.1 Wiring Diagram

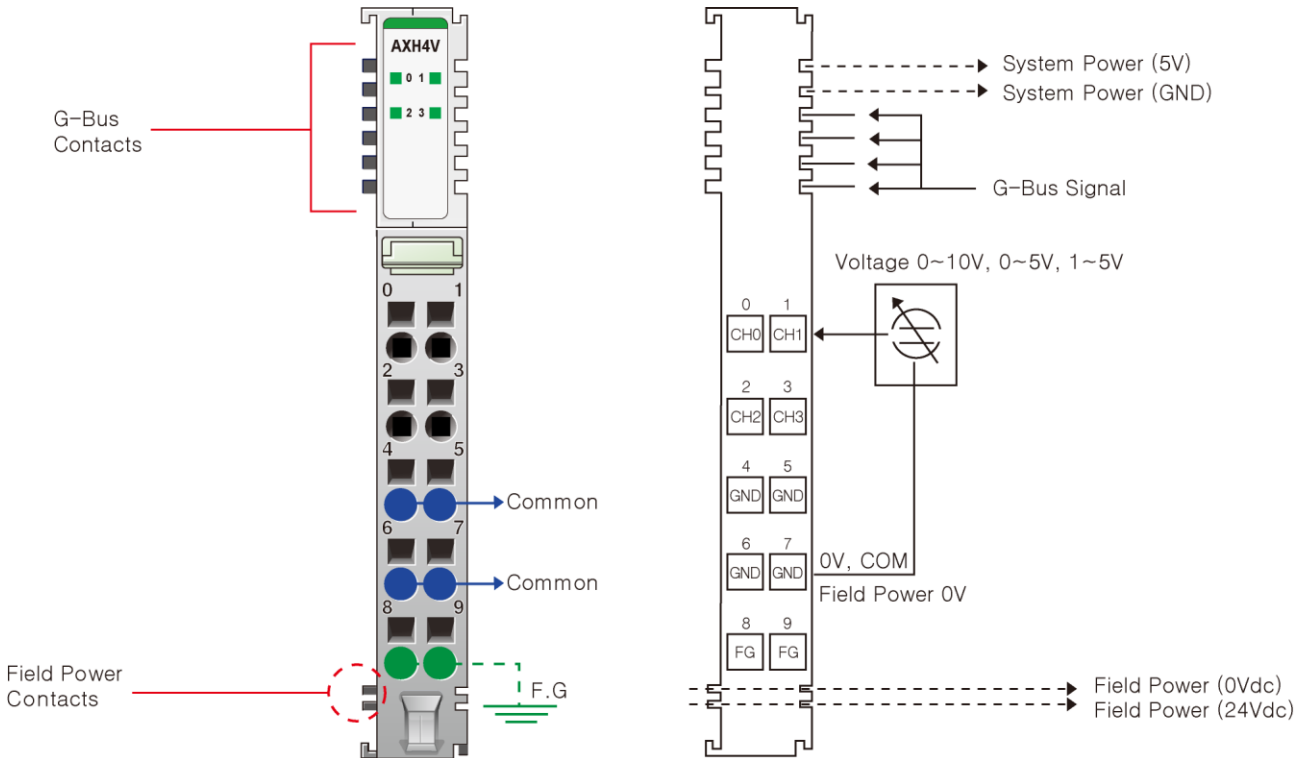

Pin No.	Signal Description	Signal Description	Pin No.
0	Input Channel 0	Input Channel 1	1
2	Input Channel 2	Input Channel 3	3
4	Input Channel Common (AGND)	Input Channel Common (AGND)	5
6	Input Channel Common (AGND)	Input Channel Common (AGND)	7
8	F.G	F.G	9

3.2.2 LED Indicator

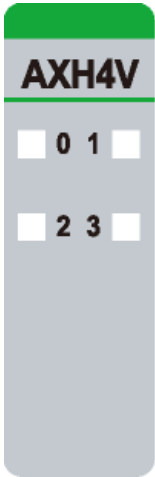

LED No.	LED Function / Description	LED Color
0	Input Channel 0	Green
1	Input Channel 1	Green
2	Input Channel 2	Green
3	Input Channel 3	Green

3.2.3 Channel Status LED

Status	LED	To indicate
Normal Operation	[LED Off < 0.5% (Maximum Input Value)] - Channel OFF [LED On > 0.5% (Maximum Input Value)] - Channel Green	Normal Operation
Field Power Error	All Channel Repeat the Green and Off	Field Power is unconnected

3.2.4 Environment Specification

Environmental Specification	
Operation Temperature	-40°C ~ 70°C
UL Temperature	-20°C ~ 60°C
Storage Temperature	-40°C ~ 85°C
Relative Humidity	5% ~ 90% Non-condensing
Mounting	DIN Rail
General Specification	
Shock Operating	IEC 60068-2-27
Vibration Resistance	Based on IEC 60068-2-6 DNVGL-CG-0039: Vibration Class B, 4g
Industrial Emissions	EN61000-6-4/All: 2007 +A1: 2011
Industrial Immunity	EN61000-6-2: 2005
Installation Position	Vertical and horizontal installation is available
Product Certifications	CE, UL, EAC

3.2.5 Specification

Items	Specification
Input Specification	
Inputs Per Module	4 Channels Single Ended, Non-Isolated Between Channel
Indicators (Logic side)	4 Green Input Status
Resolution in Ranges	16 bits (Include Sign) 15 bits: 0.31mV/bit (0~10V), 0.15mV/bit (0~5V), 0.12mV/bit (1~5V)
Input Current Ranges	0~10Vdc, 0~5Vdc, 1~5Vdc
Data Format	16 Bits Integer (2' complement)
Module Error	±0.1% Full Scale @ 25°C ambient ±0.3% Full Scale @ -40°C ~ 70°C
Input Impedance	500 kΩ
Diagnostic	Diagnostic Field Power Off: LED Blinking Field Power On: LED Off < 0.5% (Maximum Input Value) Field Power On: LED On > 0.5% (Maximum Input Value)
Conversion Time	0.4msec / All Channels
Field Calibration	Not Required
Common Type	4 Common, Field Power 0V is Common (AGND)
General Specification	
Power Dissipation	Max. 25mA @ 5.0Vdc
Isolation	I/O to Logic: Isolation Field Power: Non-Isolation
UL Field Power	Supply Voltage: 24Vdc nominal, Class 2
Field Power	Supply Voltage: 24Vdc nominal Voltage Range: 18~30Vdc Power Dissipation: Max. 25mA @ 24Vdc
Wiring	I/O Cable Max. 2.0mm ² (AWG 14)
Torque	0.8Nm (7lb-in)
Weight	58g
Module Size	12mm x 99mm x 70mm
Environment Condition	Refer to 'Environment Specification'

3.2.6 Data Value / Voltage

Voltage Range: 0 ~ 10Vdc

Voltage	0.0V	2.5V	5.0V	10.0V
Data(Hex)	H0000	H1FFF	H3FFF	H7FFF

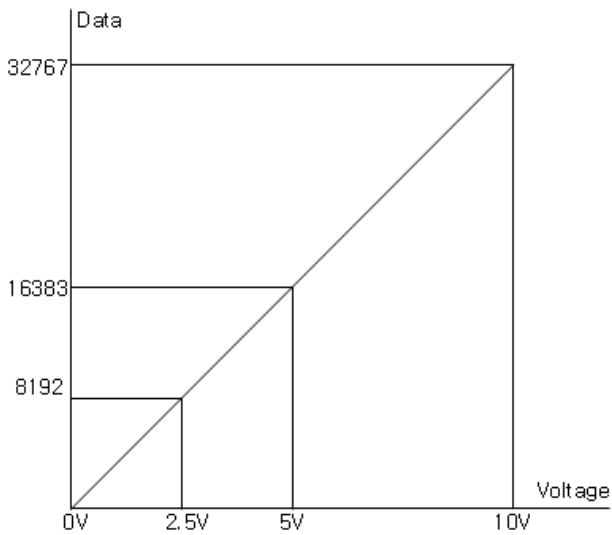

Voltage Range: 0 ~ 5Vdc

Voltage	0.0V	1.25V	2.5V	5.0V
Data(Hex)	H0000	H1FFF	H3FFF	H7FFF

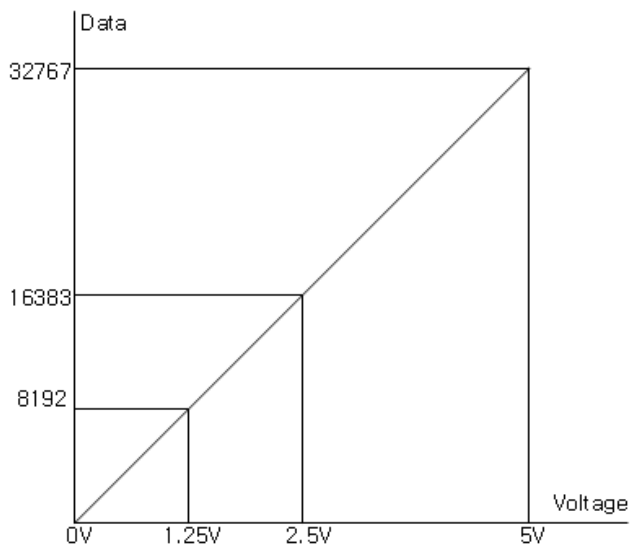

Voltage Range: 1 ~ 5Vdc

Voltage	1.0V	2.0V	3.0V	5.0V
Data(Hex)	H0000	H1FFF	H3FFF	H7FFF

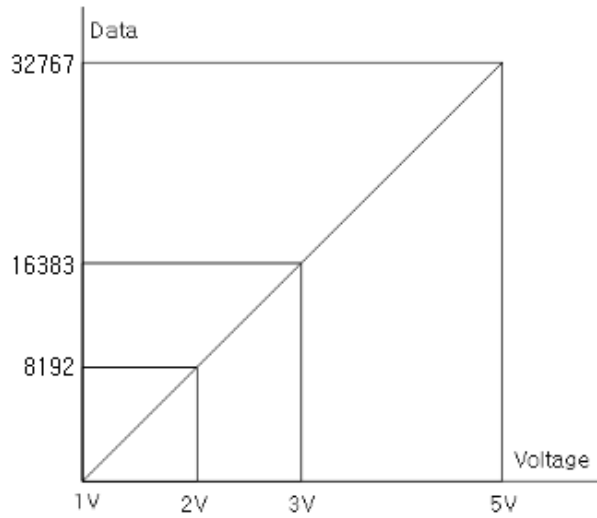

3.2.7 Mapping Data into the Image Table.

Input Module Data

Analog Input Ch0
Analog Input Ch1
Analog Input Ch2
Analog Input Ch3

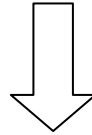

Input Image Value

Bit No	Bit7	Bit6	Bit5	Bit4	Bit3	Bit2	Bit1	Bit0
Byte 0	Analog Input Ch0 Low byte							
Byte 1	Analog Input Ch0 High byte							
Byte 2	Analog Input Ch1 Low byte							
Byte 3	Analog Input Ch1 High byte							
Byte 4	Analog Input Ch2 Low byte							
Byte 5	Analog Input Ch2 High byte							
Byte 6	Analog Input Ch3 Low byte							
Byte 7	Analog Input Ch3 High byte							

3.2.8 Parameter Data

Valid Parameter length: 6 Bytes

Parameter Data

Bit No	Bit7	Bit6	Bit5	Bit4	Bit3	Bit2	Bit1	Bit0
Byte 0	Voltage Range for Channel 0 (H00: 0~10Vdc, H01: 0~5Vdc, H02: 1~5Vdc)							
Byte 1	Voltage Range for Channel 1 (H00: 0~10Vdc, H01: 0~5Vdc, H02: 1~5Vdc)							
Byte 2	Voltage Range for Channel 2 (H00: 0~10Vdc, H01: 0~5Vdc, H02: 1~5Vdc)							
Byte 3	Voltage Range for Channel 3 (H00: 0~10Vdc, H01: 0~5Vdc, H02: 1~5Vdc)							
Byte 4	Filter Time (H00: Default Filter (20) / H01: Fastest ~ / H3E : Slowest)							
Byte 5	Not used (=00)							

3.3 RIO3-AX8V

3.3.1 Wiring Diagram

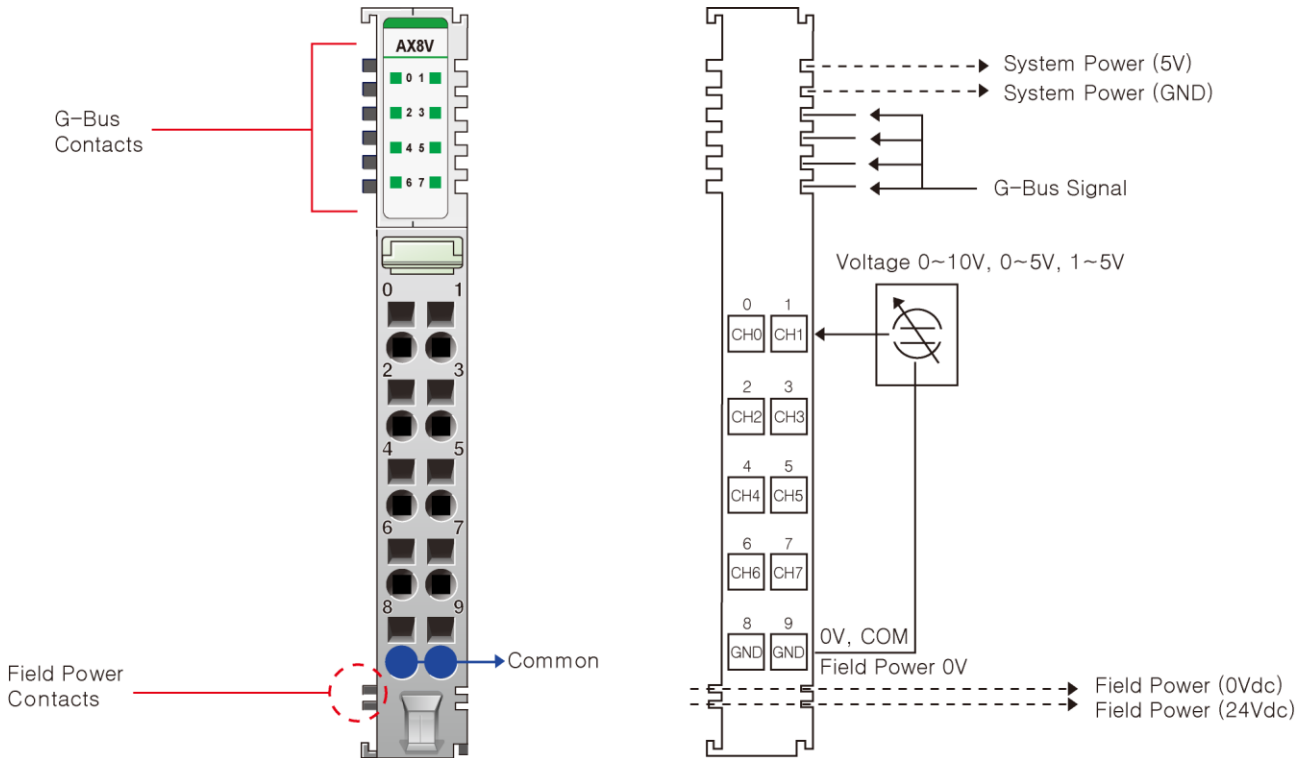

Pin No.	Signal Description	Signal Description	Pin No.
0	Input Channel 0	Input Channel 1	1
2	Input Channel 2	Input Channel 3	3
4	Input Channel 4	Input Channel 5	5
6	Input Channel 6	Input Channel 7	7
8	Input Channel Common (AGND)	Input Channel Common (AGND)	9

3.3.2 LED Indicator

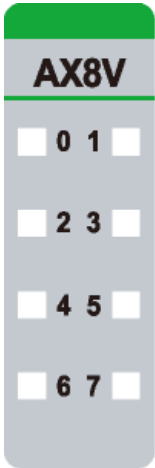

LED No.	LED Function / Description	LED Color
0	Input Channel 0	Green
1	Input Channel 1	Green
2	Input Channel 2	Green
3	Input Channel 3	Green
4	Input Channel 4	Green
5	Input Channel 5	Green
6	Input Channel 6	Green
7	Input Channel 7	Green

3.3.3 Channel Status LED

Status	LED	To indicate
Normal Operation	[LED Off < 0.5% (Maximum Input Value)] - Channel OFF [LED On > 0.5% (Maximum Input Value)] - Channel Green	Normal Operation
Field Power Error	All Channel Repeat the Green and Off	Field Power is unconnected

3.3.4 Environment Specification

Environmental Specification	
Operation Temperature	-40°C ~ 70°C
UL Temperature	-20°C ~ 60°C
Storage Temperature	-40°C ~ 85°C
Relative Humidity	5% ~ 90% Non-condensing
Mounting	DIN Rail
General Specification	
Shock Operating	IEC 60068-2-27
Vibration Resistance	Based on IEC 60068-2-6 DNVGL-CG-0039: Vibration Class B, 4g
Industrial Emissions	EN61000-6-4: 2007 +A1: 2011
Industrial Immunity	EN61000-6-2: 2005
Installation Position	Vertical and horizontal installation is possible
Product Certifications	CE, UL, EAC

3.3.5 Specification

Items	Specification
Input Specification	
Inputs Per Module	8 Channels Single Ended, Non-Isolated Between Channel
Indicators(Logic side)	8 Green Input Status
Resolution in Ranges	12 bits: 2.44mV/Bit (0~10V), 1.22mV/Bit (0~5V) 0.98mV/Bit (1~5V)
Input Current Ranges	0~10Vdc, 0~5Vdc, 1~5Vdc
Data Format	16 Bits Integer (2' compliment)
Module Error	±0.1% Full Scale @ 25°C ambient ±0.3% Full Scale @ -40°C ~ 70°C
Input Impedance	500 kΩ
Diagnostic	Diagnostic Field Power Off: LED Blinking Field Power On : LED Off < 0.5% (Maximum Input Value) Field Power On : LED On > 0.5% (Maximum Input Value)
Conversion Time	0.5msec / All Channels
Field Calibration	Not Required
Common Type	2 Common, Field Power 0V is Common(AGND)
General Specification	
Power Dissipation	Max. 30mA @ 5.0Vdc
Isolation	I/O to Logic: Isolation Field Power: Non-Isolation
UL Field Power	Supply Voltage: 24Vdc nominal, Class 2
Field Power	Supply Voltage: 24Vdc nominal Voltage Range: 18~30Vdc Power Dissipation: Max. 30mA @ 24Vdc
Wiring	I/O Cable Max. 2.0mm ² (AWG 14)
Torque	0.8Nm (7lb-in)
Weight	58g
Module Size	12mm x 99mm x 70mm
Environment Condition	Refer to 'Environment Specification'

3.3.6 Data Value / Voltage

Voltage Range: 0 ~ 10Vdc

Voltage	0.0V	2.5V	5.0V	10.0V
Data(Hex)	H0000	H03FF	H07FF	H0FFF

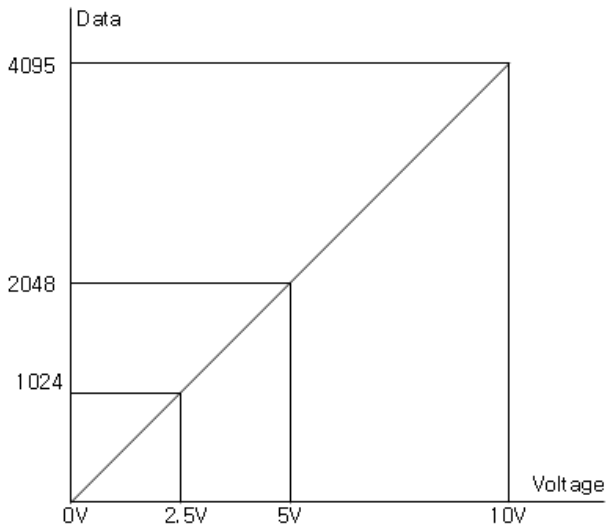

Voltage Range: 0 ~ 5Vdc

Voltage	0.0V	1.25V	2.5V	5.0V
Data(Hex)	H0000	H03FF	H07FF	H0FFF

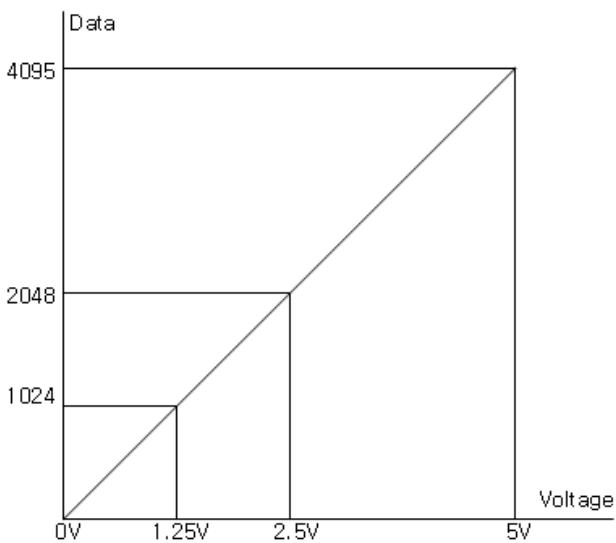

Voltage Range: 1 ~ 5Vdc

Voltage	1.0V	2.0V	3.0V	5.0V
Data(Hex)	H0000	H03FF	H07FF	H0FFF

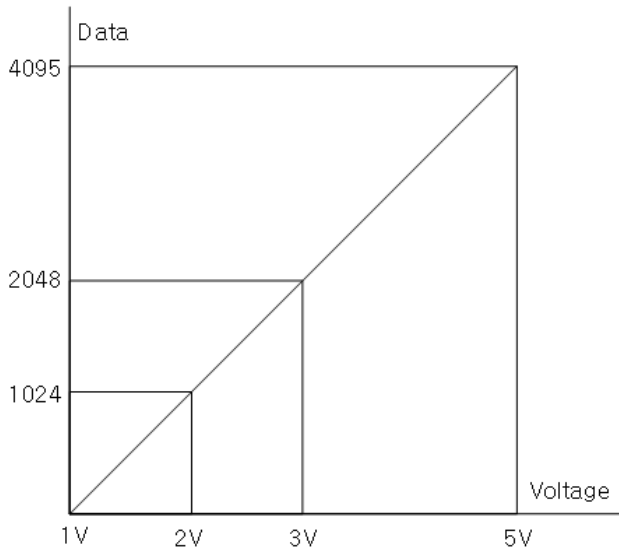

3.3.7 Mapping Data into the Image Table.

Input Module Data

Analog Input Ch0
Analog Input Ch1
Analog Input Ch2
Analog Input Ch3
Analog Input Ch4
Analog Input Ch5
Analog Input Ch6
Analog Input Ch7

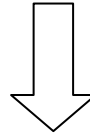

Input Image Value

Bit No	Bit7	Bit6	Bit5	Bit4	Bit3	Bit2	Bit1	Bit0
Byte 0	Analog Input Ch0 Low byte							
Byte 1	Analog Input Ch0 High byte							
Byte 2	Analog Input Ch1 Low byte							
Byte 3	Analog Input Ch1 High byte							
Byte 4	Analog Input Ch2 Low byte							
Byte 5	Analog Input Ch2 High byte							
Byte 6	Analog Input Ch3 Low byte							
Byte 7	Analog Input Ch3 High byte							
Byte 8	Analog Input Ch4 Low byte							
Byte 9	Analog Input Ch4 High byte							
Byte 10	Analog Input Ch5 Low byte							
Byte 11	Analog Input Ch5 High byte							
Byte 12	Analog Input Ch6 Low byte							
Byte 13	Analog Input Ch6 High byte							
Byte 14	Analog Input Ch7 Low byte							
Byte 15	Analog Input Ch7 High byte							

3.3.8 Parameter Data

Valid Parameter length: 10 Bytes

Parameter Data

Bit No	Bit7	Bit6	Bit5	Bit4	Bit3	Bit2	Bit1	Bit0
Byte 0	Voltage Range for Channel 0 (H00: 0~10Vdc, H01: 0~5Vdc, H02: 1~5Vdc)							
Byte 1	Voltage Range for Channel 1 (H00: 0~10Vdc, H01: 0~5Vdc, H02: 1~5Vdc)							
Byte 2	Voltage Range for Channel 2 (H00: 0~10Vdc, H01: 0~5Vdc, H02: 1~5Vdc)							
Byte 3	Voltage Range for Channel 3 (H00: 0~10Vdc, H01: 0~5Vdc, H02: 1~5Vdc)							
Byte 4	Voltage Range for Channel 4 (H00: 0~10Vdc, H01: 0~5Vdc, H02: 1~5Vdc)							
Byte 5	Voltage Range for Channel 5 (H00: 0~10Vdc, H01: 0~5Vdc, H02: 1~5Vdc)							
Byte 6	Voltage Range for Channel 6 (H00: 0~10Vdc, H01: 0~5Vdc, H02: 1~5Vdc)							
Byte 7	Voltage Range for Channel 7 (H00: 0~10Vdc, H01: 0~5Vdc, H02: 1~5Vdc)							
Byte 8	Filter Time (H00: Default Filter (20) / H01: Fastest ~ / H3E: Slowest)							
Byte 9	Not used (=00)							

3.4 RIO3-AXH8V

3.4.1 Wiring Diagram

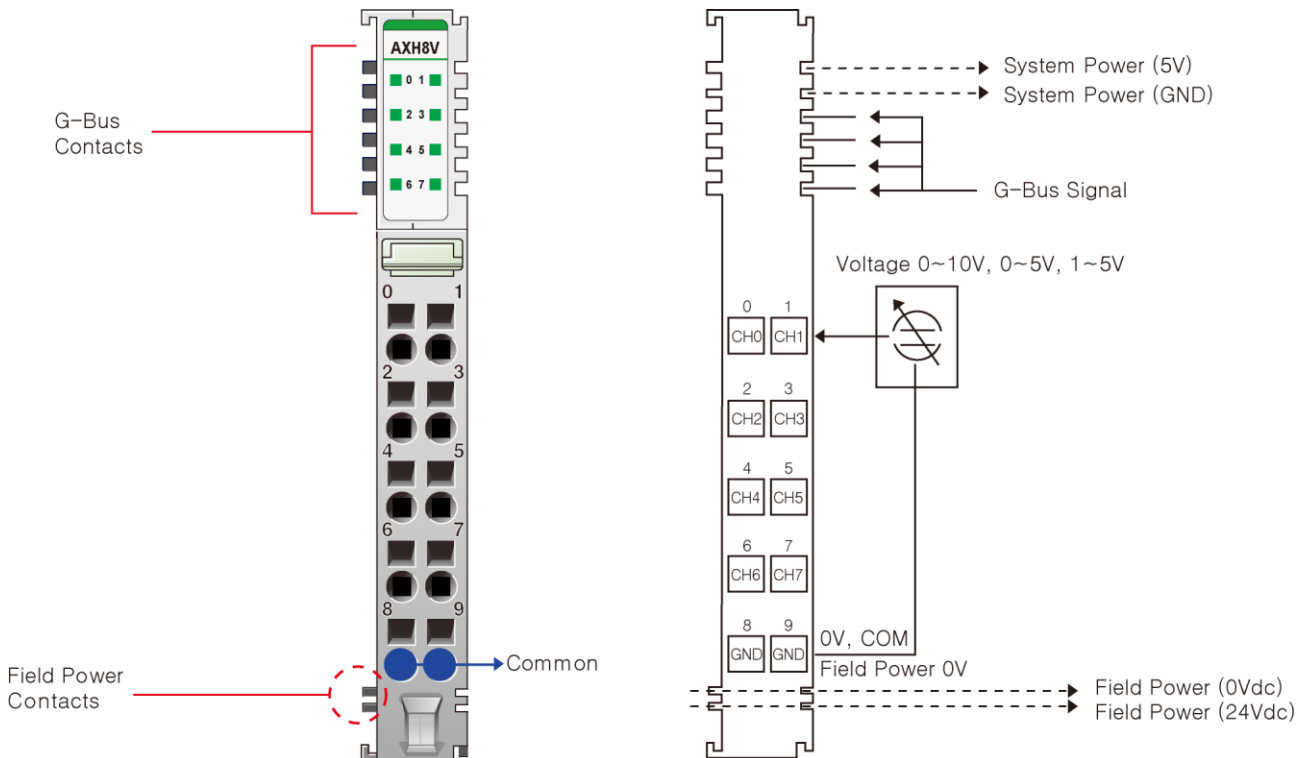

Pin No.	Signal Description	Signal Description	Pin No.
0	Input Channel 0	Input Channel 1	1
2	Input Channel 2	Input Channel 3	3
4	Input Channel 4	Input Channel 5	5
6	Input Channel 6	Input Channel 7	7
8	Input Channel Common (AGND)	Input Channel Common (AGND)	9

3.4.2 LED Indicator

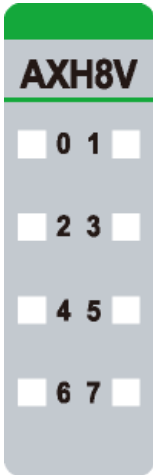

LED No.	LED Function / Description	LED Color
0	Input Channel 0	Green
1	Input Channel 1	Green
2	Input Channel 2	Green
3	Input Channel 3	Green
4	Input Channel 4	Green
5	Input Channel 5	Green
6	Input Channel 6	Green
7	Input Channel 7	Green

3.4.3 Channel Status LED

Status	LED	To indicate
Normal Operation	[LED Off < 0.5% (Maximum Input Value)] - Channel OFF [LED On > 0.5% (Maximum Input Value)] - Channel Green	Normal Operation
Field Power Error	All Channel Repeat the Green and Off	Field Power is unconnected

3.4.4 Environment Specification

Environmental Specification	
Operation Temperature	-40°C ~ 70°C
UL Temperature	-20°C ~ 60°C
Storage Temperature	-40°C ~ 85°C
Relative Humidity	5% ~ 90% Non-condensing
Mounting	DIN Rail
General Specification	
Shock Operating	IEC 60068-2-27
Vibration Resistance	Based on IEC 60068-2-6 DNVGL-CG-0039: Vibration Class B, 4g
Industrial Emissions	EN61000-6-4: 2007 +A1: 2011
Industrial Immunity	EN61000-6-2: 2005
Installation Position	Vertical and horizontal installation is possible
Product Certifications	CE, UL, EAC

3.4.5 Specification

Items	Specification
Input Specification	
Inputs Per Module	8 Channels Single Ended, Non-Isolated Between Channel
Indicators (Logic side)	8 Green Input Status
Resolution in Ranges	16 bits (Include Sign) 15 bits: 0.31mV/bit (0~10V), 0.15mV/bit (0~5V), 0.12mV/bit (1~5V)
Input Current Ranges	0~10Vdc, 0~5Vdc, 1~5Vdc
Data Format	16 Bits Integer (2' compliment)
Module Error	±0.1% Full Scale @ 25°C ambient ±0.3% Full Scale @ -40°C ~ 70°C
Input Impedance	500 kΩ
Diagnostic	Diagnostic Field Power Off: LED Blinking Field Power On: LED Off < 0.5% (Maximum Input Value) Field Power On: LED On > 0.5% (Maximum Input Value)
Conversion Time	0.4msec / All Channels
Field Calibration	Not Required
Common Type	2 Common, Field Power 0V is Common (AGND)
General Specification	
Power Dissipation	Max. 30mA @ 5.0Vdc
Isolation	I/O to Logic: Isolation Field Power: Non-Isolation
UL Field Power	Supply Voltage: 24Vdc nominal, Class 2
Field Power	Supply Voltage: 24Vdc nominal Voltage Range: 18~30Vdc Power Dissipation: Max. 30mA @ 24Vdc
Wiring	I/O Cable Max. 2.0mm ² (AWG 14)
Torque	0.8Nm (7lb-in)
Weight	58g
Module Size	12mm x 99mm x 70mm
Environment Condition	Refer to 'Environment Specification'

3.4.6 Data Value / Voltage

Voltage Range: 0 ~ 10Vdc

Voltage	0.0V	2.5V	5.0V	10.0V
Data(Hex)	H0000	H1FFF	H3FFF	H7FFF

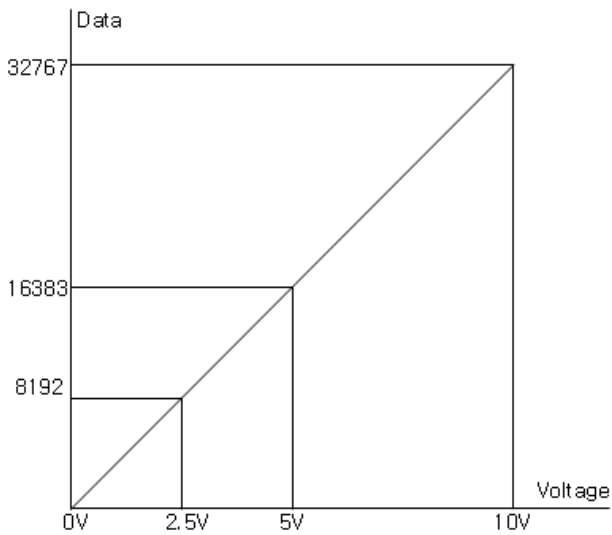

Voltage Range: 0 ~ 5Vdc

Voltage	0.0V	1.25V	2.5V	5.0V
Data(Hex)	H0000	H1FFF	H3FFF	H7FFF

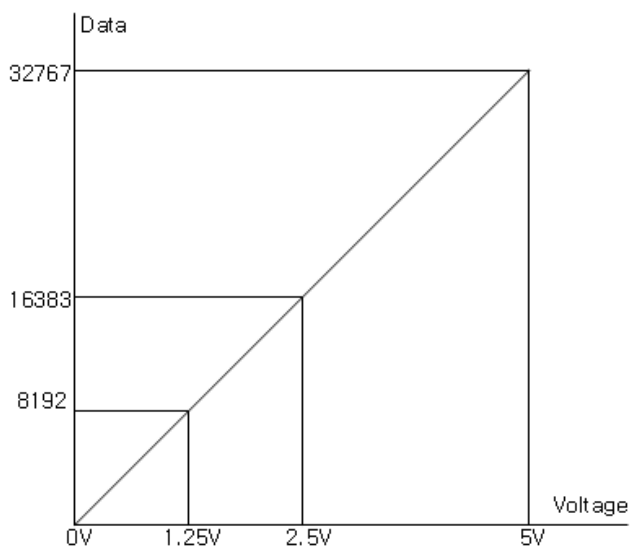

Voltage Range: 1 ~ 5Vdc

Voltage	1.0V	2.0V	3.0V	5.0V
Data(Hex)	H0000	H1FFF	H3FFF	H7FFF

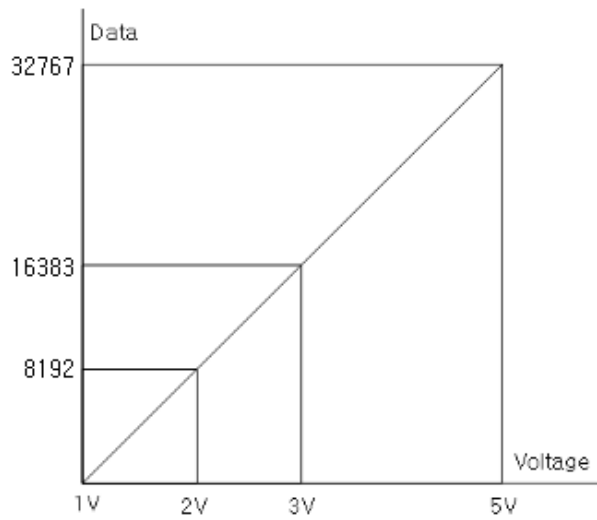

3.4.7 Mapping Data into the Image Table.

Input Module Data

Analog Input Ch0
Analog Input Ch1
Analog Input Ch2
Analog Input Ch3
Analog Input Ch4
Analog Input Ch5
Analog Input Ch6
Analog Input Ch7

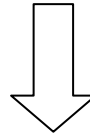

Input Image Value

Bit No	Bit7	Bit6	Bit5	Bit4	Bit3	Bit2	Bit1	Bit0
Byte 0	Analog Input Ch0 Low byte							
Byte 1	Analog Input Ch0 High byte							
Byte 2	Analog Input Ch1 Low byte							
Byte3	Analog Input Ch1 High byte							
Byte4	Analog Input Ch2 Low byte							
Byte5	Analog Input Ch2 High byte							
Byte6	Analog Input Ch3 Low byte							
Byte7	Analog Input Ch3 High byte							
Byte8	Analog Input Ch4 Low byte							
Byte9	Analog Input Ch4 High byte							
Byte10	Analog Input Ch5 Low byte							
Byte11	Analog Input Ch5 High byte							
Byte12	Analog Input Ch6 Low byte							
Byte13	Analog Input Ch6 High byte							
Byte14	Analog Input Ch7 Low byte							
Byte15	Analog Input Ch7 High byte							

3.4.8 Parameter Data

Valid Parameter length: 10 Bytes

Parameter Data

Bit No	Bit7	Bit6	Bit5	Bit4	Bit3	Bit2	Bit1	Bit0
Byte 0	Voltage Range for Channel 0 (H00: 0~10Vdc, H01: 0~5Vdc, H02: 1~5Vdc)							
Byte 1	Voltage Range for Channel 1 (H00: 0~10Vdc, H01: 0~5Vdc, H02: 1~5Vdc)							
Byte 2	Voltage Range for Channel 2 (H00: 0~10Vdc, H01: 0~5Vdc, H02: 1~5Vdc)							
Byte 3	Voltage Range for Channel 3 (H00: 0~10Vdc, H01: 0~5Vdc, H02: 1~5Vdc)							
Byte 4	Voltage Range for Channel 4 (H00: 0~10Vdc, H01: 0~5Vdc, H02: 1~5Vdc)							
Byte 5	Voltage Range for Channel 5 (H00: 0~10Vdc, H01: 0~5Vdc, H02: 1~5Vdc)							
Byte 6	Voltage Range for Channel 6 (H00: 0~10Vdc, H01: 0~5Vdc, H02: 1~5Vdc)							
Byte 7	Voltage Range for Channel 7 (H00: 0~10Vdc, H01: 0~5Vdc, H02: 1~5Vdc)							
Byte 8	Filter Time (H00: Default Filter (20) / H01: Fastest ~ / H3E: Slowest)							
Byte 9	Not used (=00)							

3.5 RIO3-AX16VC

3.5.1 Wiring Diagram

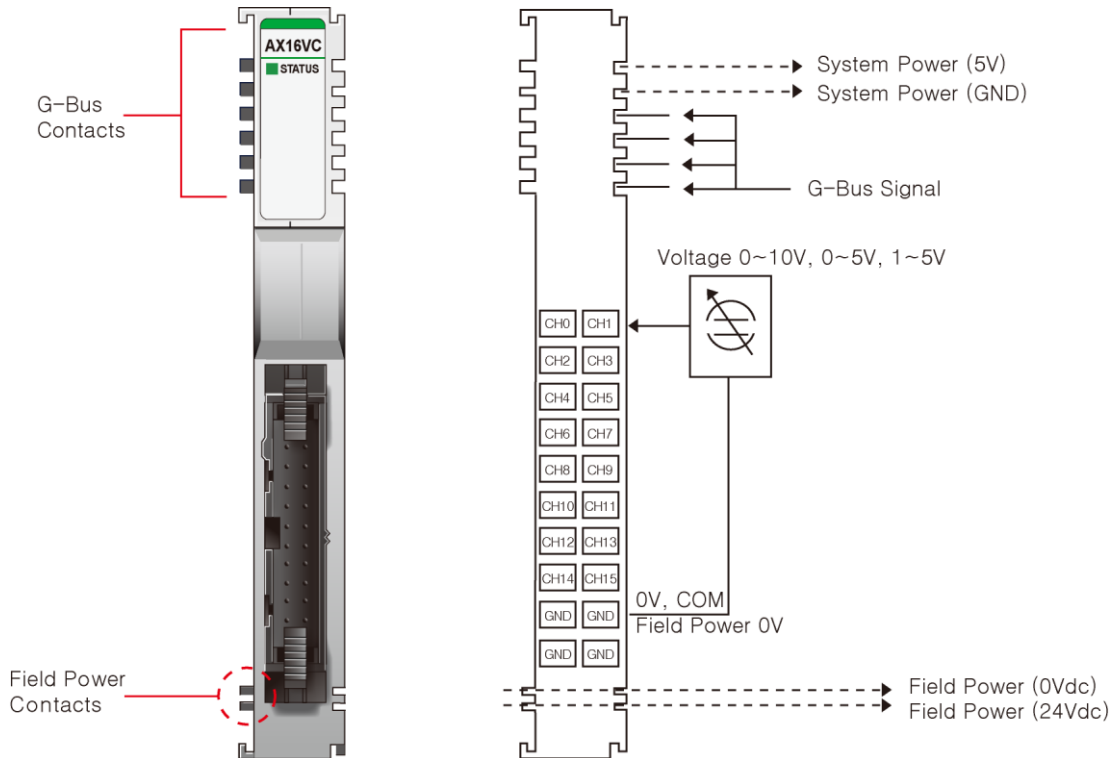

Pin No.	Signal Description	Signal Description	Pin No.
0	Input Channel 0	Input Channel 1	1
2	Input Channel 2	Input Channel 3	3
4	Input Channel 4	Input Channel 5	5
6	Input Channel 6	Input Channel 7	7
8	Input Channel 8	Input Channel 9	9
10	Input Channel 10	Input Channel 11	11
12	Input Channel 12	Input Channel 13	13
14	Input Channel 14	Input Channel 15	15
16	Input Channel Common (AGND)	Input Channel Common (AGND)	17
18	Input Channel Common (AGND)	Input Channel Common (AGND)	19

3.5.2 LED Indicator

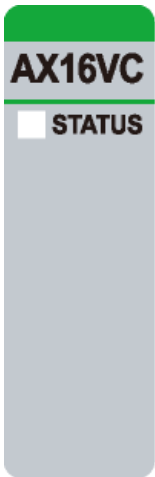

LED No.	LED Function / Description	LED Color
0	Status LED	Green

3.5.3 Channel Status LED

Status	LED	To indicate
G-Bus Status	Off Green	Disconnection connection
Field Power Error	All Channel Repeat the Green and Off	Field Power is unconnected

3.5.4 Environment Specification

Environmental Specification	
Operation Temperature	-40°C ~ 60°C
UL Temperature	-20°C ~ 60°C
Storage Temperature	-40°C ~ 85°C
Relative Humidity	5% ~ 90% Non-condensing
Mounting	DIN Rail
General Specification	
Shock Operating	IEC 60068-2-27
Vibration Resistance	Based on IEC 60068-2-6 DNVGL-CG-0039: Vibration Class B, 4g
Industrial Emissions	EN61000-6-4: 2007 +A1: 2011
Industrial Immunity	EN61000-6-2: 2005
Installation Position	Vertical and horizontal installation is possible
Product Certifications	CE, UL, EAC

3.5.5 Specification

Items	Specification
Input Specification	
Inputs Per Module	16 Channels Single Ended, Non-Isolated Between Channel
Indicators(Logic side)	1 Green Input Status
Resolution in Ranges	12 bits: 2.44mV/Bit (0~10V), 1.22mV/Bit (0~5V) 0.98mV/Bit (1~5V)
Input Current Ranges	0~10Vdc, 0~5Vdc, 1~5Vdc
Data Format	16 Bits Integer (2' complement)
Module Error	±0.1% Full Scale @ 25°C ambient ±0.3% Full Scale @ -40°C ~ 60°C
Input Impedance	500 kΩ
Diagnostic	Diagnostic Field Power Off: LED Blinking
Conversion Time	1.0msec / All Channel
Field Calibration	Not Required
Common Type	4 Common, Field Power 0V is Common (AGND)
General Specification	
Power Dissipation	Max. 30mA @ 5.0Vdc
Isolation	I/O to Logic: Isolation Field Power: Non-Isolation
UL Field Power	Supply Voltage: 24Vdc nominal, Class 2
Field Power	Supply Voltage: 24Vdc nominal Voltage Range: 18~26.4Vdc Power Dissipation: Max. 35mA @ 24Vdc
Wiring	Connector Type, up to AWG22 Module Connector: HIF3BA-20D-2.54DSA
Weight	58g
Module Size	12mm x 99mm x 70mm
Environment Condition	Refer to 'Environment Specification'

3.5.6 Data Value / Voltage

Voltage Range: 0 ~ 10Vdc

Voltage	0.0V	2.5V	5.0V	10.0V
Data(Hex)	H0000	H03FF	H07FF	H0FFF

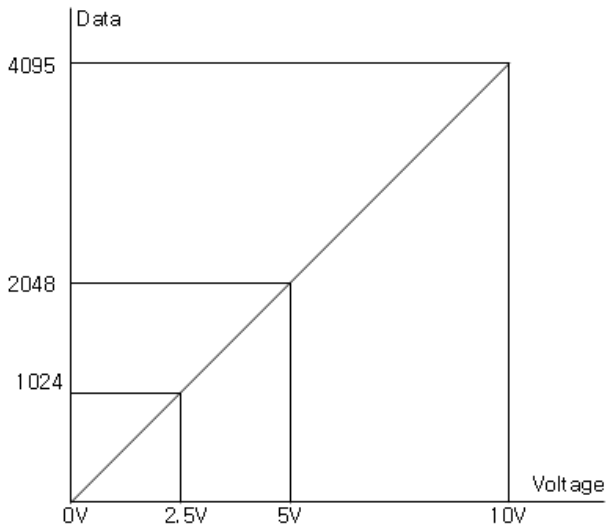

Voltage Range: 0 ~ 5Vdc

Voltage	0.0V	1.25V	2.5V	5.0V
Data(Hex)	H0000	H03FF	H07FF	H0FFF

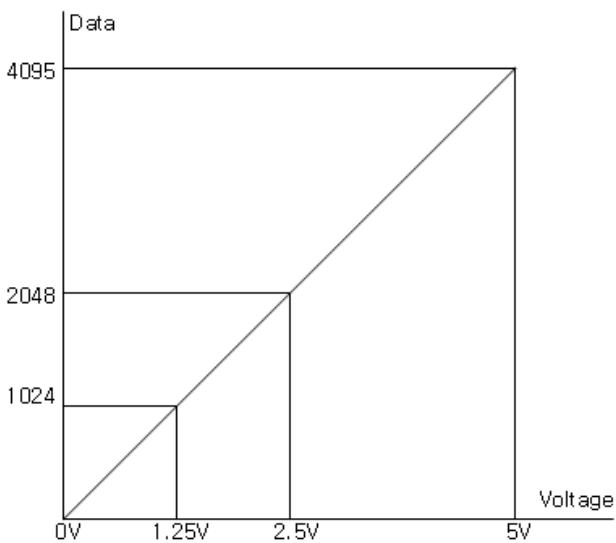

Voltage Range: 1 ~ 5Vdc

Voltage	1.0V	2.0V	3.0V	5.0V
Data(Hex)	H0000	H03FF	H07FF	H0FFF

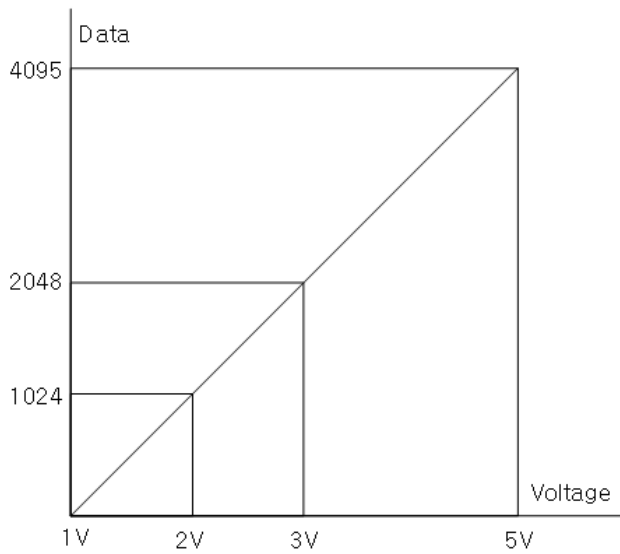

3.5.7 Mapping Data into the Image Table.

Input Module Data

Analog Input Ch0
Analog Input Ch1
Analog Input Ch2
Analog Input Ch3
Analog Input Ch4
Analog Input Ch5
Analog Input Ch6
Analog Input Ch7
Analog Input Ch8
Analog Input Ch9
Analog Input Ch10
Analog Input Ch11
Analog Input Ch12
Analog Input Ch13
Analog Input Ch14
Analog Input Ch15

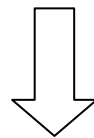

Input Image Value

Bit No	Bit7	Bit6	Bit5	Bit4	Bit3	Bit2	Bit1	Bit0
Byte 0	Analog Input Ch0 Low byte							
Byte 1	Analog Input Ch0 High byte							
Byte 2	Analog Input Ch1 Low byte							
Byte 3	Analog Input Ch1 High byte							
Byte 4	Analog Input Ch2 Low byte							
Byte 5	Analog Input Ch2 High byte							
Byte 6	Analog Input Ch3 Low byte							
Byte 7	Analog Input Ch3 High byte							
Byte 8	Analog Input Ch4 Low byte							
Byte 9	Analog Input Ch4 High byte							
Byte 10	Analog Input Ch5 Low byte							
Byte 11	Analog Input Ch5 High byte							
Byte 12	Analog Input Ch6 Low byte							
Byte 13	Analog Input Ch6 High byte							
Byte 14	Analog Input Ch7 Low byte							
Byte 15	Analog Input Ch7 High byte							

Byte 16	Analog Input Ch8 Low byte
Byte 17	Analog Input Ch8 High byte
Byte 18	Analog Input Ch9 Low byte
Byte 19	Analog Input Ch9 High byte
Byte 20	Analog Input Ch10 Low byte
Byte 21	Analog Input Ch10 High byte
Byte 22	Analog Input Ch11 Low byte
Byte 23	Analog Input Ch11 High byte
Byte 24	Analog Input Ch12 Low byte
Byte 25	Analog Input Ch12 High byte
Byte 26	Analog Input Ch13 Low byte
Byte 27	Analog Input Ch13 High byte
Byte 28	Analog Input Ch14 Low byte
Byte 29	Analog Input Ch14 High byte
Byte 30	Analog Input Ch15 Low byte
Byte 31	Analog Input Ch15 High byte

3.5.8 Parameter Data

Valid Parameter length: 18 Bytes

Parameter Data

Bit No	Bit7	Bit6	Bit5	Bit4	Bit3	Bit2	Bit1	Bit0
Byte 0	Voltage Range for Channel 0 (H00: 0~10Vdc, H01: 0~5Vdc, H02: 1~5Vdc)							
Byte 1	Voltage Range for Channel 1 (H00: 0~10Vdc, H01: 0~5Vdc, H02: 1~5Vdc)							
Byte 2	Voltage Range for Channel 2 (H00: 0~10Vdc, H01: 0~5Vdc, H02: 1~5Vdc)							
Byte 3	Voltage Range for Channel 3 (H00: 0~10Vdc, H01: 0~5Vdc, H02: 1~5Vdc)							
Byte 4	Voltage Range for Channel 4 (H00: 0~10Vdc, H01: 0~5Vdc, H02: 1~5Vdc)							
Byte 5	Voltage Range for Channel 5 (H00: 0~10Vdc, H01: 0~5Vdc, H02: 1~5Vdc)							
Byte 6	Voltage Range for Channel 6 (H00: 0~10Vdc, H01: 0~5Vdc, H02: 1~5Vdc)							
Byte 7	Voltage Range for Channel 7 (H00: 0~10Vdc, H01: 0~5Vdc, H02: 1~5Vdc)							
Byte 8	Voltage Range for Channel 8 (H00: 0~10Vdc, H01: 0~5Vdc, H02: 1~5Vdc)							
Byte 9	Voltage Range for Channel 9 (H00: 0~10Vdc, H01: 0~5Vdc, H02: 1~5Vdc)							
Byte 10	Voltage Range for Channel 10 (H00: 0~10Vdc, H01: 0~5Vdc, H02: 1~5Vdc)							
Byte 11	Voltage Range for Channel 11 (H00: 0~10Vdc, H01: 0~5Vdc, H02: 1~5Vdc)							
Byte 12	Voltage Range for Channel 12 (H00: 0~10Vdc, H01: 0~5Vdc, H02: 1~5Vdc)							
Byte 13	Voltage Range for Channel 13 (H00: 0~10Vdc, H01: 0~5Vdc, H02: 1~5Vdc)							
Byte 14	Voltage Range for Channel 14 (H00: 0~10Vdc, H01: 0~5Vdc, H02: 1~5Vdc)							
Byte 15	Voltage Range for Channel 15 (H00: 0~10Vdc, H01: 0~5Vdc, H02: 1~5Vdc)							
Byte 16	Filter Time (H00: Default Filter (20) / H01: Fastest ~ / H3E: Slowest)							
Byte 17	Not used (=00)							

3.6 RIO3-AX16VT

3.6.1 Wiring Diagram

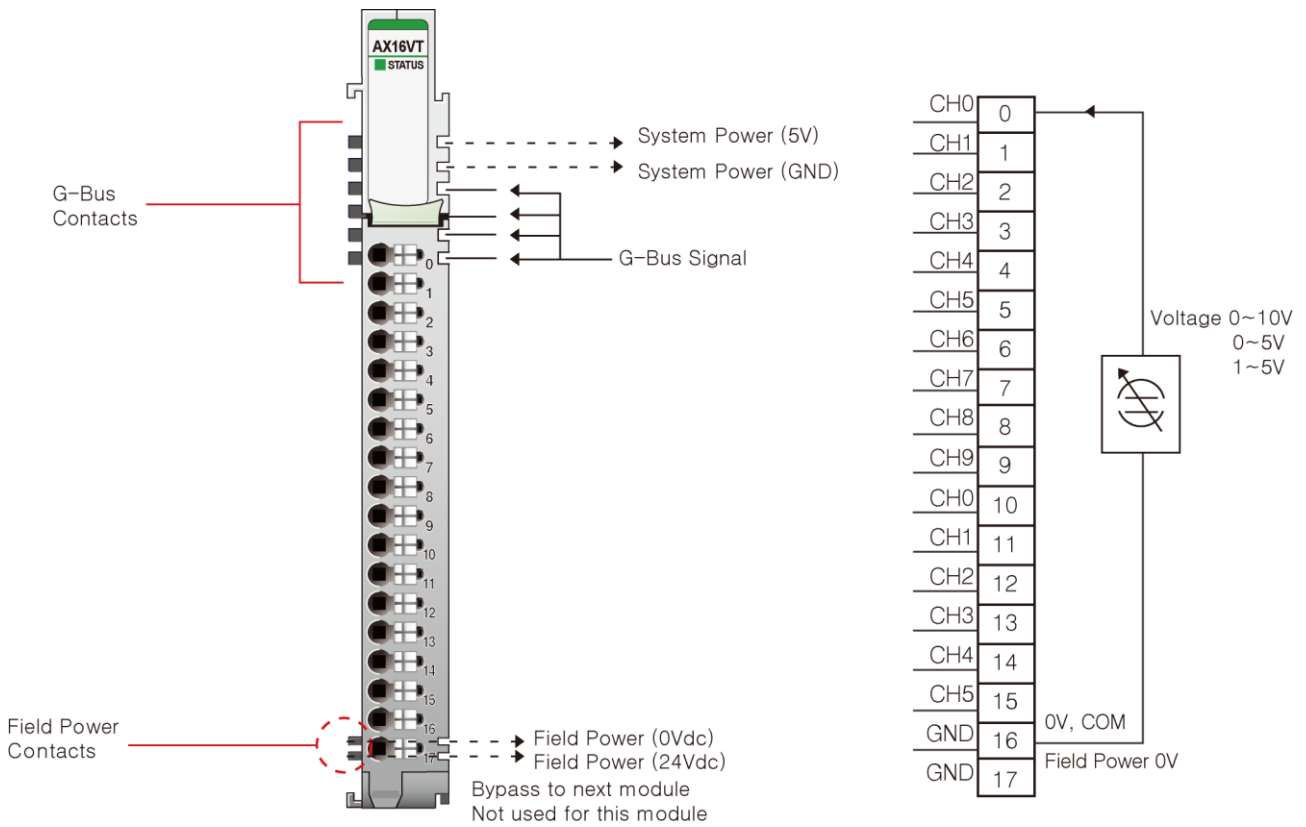

Pin No.	Signal Description
0	Input Channel 0
1	Input Channel 1
2	Input Channel 2
3	Input Channel 3
4	Input Channel 4
5	Input Channel 5
6	Input Channel 6
7	Input Channel 7
8	Input Channel 8
9	Input Channel 9
10	Input Channel 10
11	Input Channel 11
12	Input Channel 12
13	Input Channel 13
14	Input Channel 14

15	Input Channel 15
16	Input Channel Common (AGND)
17	Input Channel Common (AGND)

3.6.2 LED Indicator

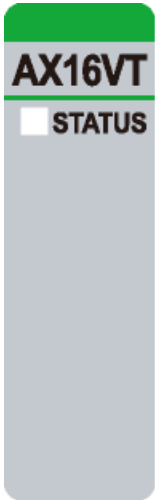

LED No.	LED Function / Description	LED Color
0	Status LED	Green

3.6.3 Channel Status LED

Status	LED	To indicate
G-Bus Status	Off Green	Disconnection connection

3.6.4 Environment Specification

Environmental Specification	
Operation Temperature	-40°C ~ 60°C
UL Temperature	-20°C ~ 60°C
Storage Temperature	-40°C ~ 85°C
Relative Humidity	5% ~ 90% Non-condensing
Mounting	DIN Rail
General Specification	
Shock Operating	IEC 60068-2-27
Vibration Resistance	Based on IEC 60068-2-6 DNVGL-CG-0039: Vibration Class B, 4g
Industrial Emissions	EN61000-6-4: 2007 +A1: 2011
Industrial Immunity	EN61000-6-2: 2005
Installation Position	Vertical and horizontal installation is possible
Product Certifications	CE, UL, EAC

3.6.5 Specification

Items	Specification
Input Specification	
Inputs Per Module	16 Channels Single Ended, Non-Isolated Between Channel
Indicators (Logic side)	1 Green Input Status
Resolution in Ranges	12 bits: 2.44mV/Bit (0~10V), 1.22mV/Bit (0~5V) 0.98mV/Bit (1~5V)
Input Current Ranges	0~10Vdc, 0~5Vdc, 1~5Vdc
Data Format	16 Bits Integer (2' complement)
Module Error	±0.1% Full Scale @ 25°C ambient ±0.3% Full Scale @ -40°C ~ 60°C
Input Impedance	500 kΩ
Diagnostic	Diagnostic Field Power Off: LED Blinking
Conversion Time	1.0msec / All Channel
Field Calibration	Not Required
Common Type	4 Common, Field Power 0V is Common (AGND)
General Specification	
Power Dissipation	Max. 210mA @ 5.0Vdc
Isolation	I/O to Logic: Photocoupler Isolation Field Power: Non-Isolation
UL Field Power	Supply Voltage: 24Vdc nominal, Class 2
Field Power	Not used Field Power bypass to next expansion module
Single Wiring	I/O Cable Max. 1.0mm ² (AWG18)
Weight	63g
Module Size	12mm x 109mm x 70mm
Environment Condition	Refer to 'Environment Specification'

3.6.6 Data Value / Voltage

Voltage Range: 0 ~ 10Vdc

Voltage	0.0V	2.5V	5.0V	10.0V
Data(Hex)	H0000	H03FF	H07FF	H0FFF

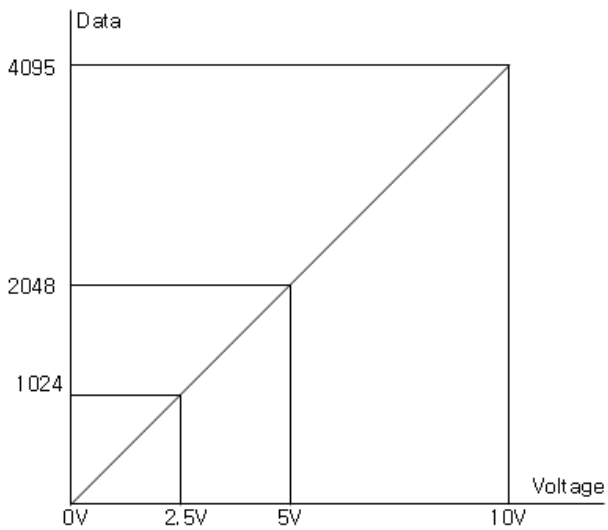

Voltage Range: 0 ~ 5Vdc

Voltage	0.0V	1.25V	2.5V	5.0V
Data(Hex)	H0000	H03FF	H07FF	H0FFF

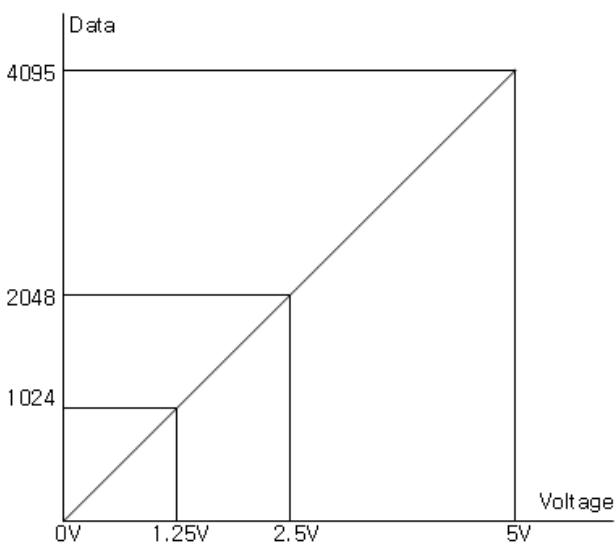

Voltage Range: 1 ~ 5Vdc

Voltage	1.0V	2.0V	3.0V	5.0V
Data(Hex)	H0000	H03FF	H07FF	H0FFF

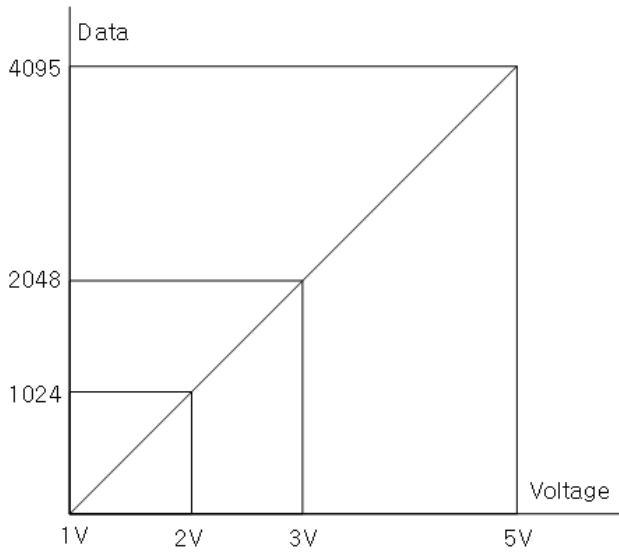

3.6.7 Mapping Data into the Image Table.

Input Module Data

Analog Input Ch0
Analog Input Ch1
Analog Input Ch2
Analog Input Ch3
Analog Input Ch4
Analog Input Ch5
Analog Input Ch6
Analog Input Ch7
Analog Input Ch8
Analog Input Ch9
Analog Input Ch10
Analog Input Ch11
Analog Input Ch12
Analog Input Ch13
Analog Input Ch14
Analog Input Ch15

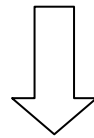

Input Image Value

Bit No	Bit7	Bit6	Bit5	Bit4	Bit3	Bit2	Bit1	Bit0
Byte 0	Analog Input Ch0 Low byte							
Byte 1	Analog Input Ch0 High byte							
Byte 2	Analog Input Ch1 Low byte							
Byte 3	Analog Input Ch1 High byte							
Byte 4	Analog Input Ch2 Low byte							
Byte 5	Analog Input Ch2 High byte							
Byte 6	Analog Input Ch3 Low byte							
Byte 7	Analog Input Ch3 High byte							
Byte 8	Analog Input Ch4 Low byte							
Byte 9	Analog Input Ch4 High byte							
Byte 10	Analog Input Ch5 Low byte							
Byte 11	Analog Input Ch5 High byte							
Byte 12	Analog Input Ch6 Low byte							
Byte 13	Analog Input Ch6 High byte							
Byte 14	Analog Input Ch7 Low byte							
Byte 15	Analog Input Ch7 High byte							

Byte 16	Analog Input Ch8 Low byte
Byte 17	Analog Input Ch8 High byte
Byte 18	Analog Input Ch9 Low byte
Byte 19	Analog Input Ch9 High byte
Byte 20	Analog Input Ch10 Low byte
Byte 21	Analog Input Ch10 High byte
Byte 22	Analog Input Ch11 Low byte
Byte 23	Analog Input Ch11 High byte
Byte 24	Analog Input Ch12 Low byte
Byte 25	Analog Input Ch12 High byte
Byte 26	Analog Input Ch13 Low byte
Byte 27	Analog Input Ch13 High byte
Byte 28	Analog Input Ch14 Low byte
Byte 29	Analog Input Ch14 High byte
Byte 30	Analog Input Ch15 Low byte
Byte 31	Analog Input Ch15 High byte

3.6.8 Parameter Data

Valid Parameter length: 18 Bytes

Parameter Data

Bit No	Bit7	Bit6	Bit5	Bit4	Bit3	Bit2	Bit1	Bit0
Byte 0	Voltage Range for Channel 0 (H00: 0~10Vdc, H01: 0~5Vdc, H02: 1~5Vdc)							
Byte 1	Voltage Range for Channel 1 (H00: 0~10Vdc, H01: 0~5Vdc, H02: 1~5Vdc)							
Byte 2	Voltage Range for Channel 2 (H00: 0~10Vdc, H01: 0~5Vdc, H02: 1~5Vdc)							
Byte 3	Voltage Range for Channel 3 (H00: 0~10Vdc, H01: 0~5Vdc, H02: 1~5Vdc)							
Byte 4	Voltage Range for Channel 4 (H00: 0~10Vdc, H01: 0~5Vdc, H02: 1~5Vdc)							
Byte 5	Voltage Range for Channel 5 (H00: 0~10Vdc, H01: 0~5Vdc, H02: 1~5Vdc)							
Byte 6	Voltage Range for Channel 6 (H00: 0~10Vdc, H01: 0~5Vdc, H02: 1~5Vdc)							
Byte 7	Voltage Range for Channel 7 (H00: 0~10Vdc, H01: 0~5Vdc, H02: 1~5Vdc)							
Byte 8	Voltage Range for Channel 8 (H00: 0~10Vdc, H01: 0~5Vdc, H02: 1~5Vdc)							
Byte 9	Voltage Range for Channel 9 (H00: 0~10Vdc, H01: 0~5Vdc, H02: 1~5Vdc)							
Byte 10	Voltage Range for Channel 10 (H00: 0~10Vdc, H01: 0~5Vdc, H02: 1~5Vdc)							
Byte 11	Voltage Range for Channel 11 (H00: 0~10Vdc, H01: 0~5Vdc, H02: 1~5Vdc)							
Byte 12	Voltage Range for Channel 12 (H00: 0~10Vdc, H01: 0~5Vdc, H02: 1~5Vdc)							
Byte 13	Voltage Range for Channel 13 (H00: 0~10Vdc, H01: 0~5Vdc, H02: 1~5Vdc)							
Byte 14	Voltage Range for Channel 14 (H00: 0~10Vdc, H01: 0~5Vdc, H02: 1~5Vdc)							
Byte 15	Voltage Range for Channel 15 (H00: 0~10Vdc, H01: 0~5Vdc, H02: 1~5Vdc)							
Byte 16	Filter Time (H00: Default Filter (20) / H01: Fastest ~ / H3E: Slowest)							
Byte 17	Not used (=00)							

4 Dimension

4.1 10-Pts. Spring Type

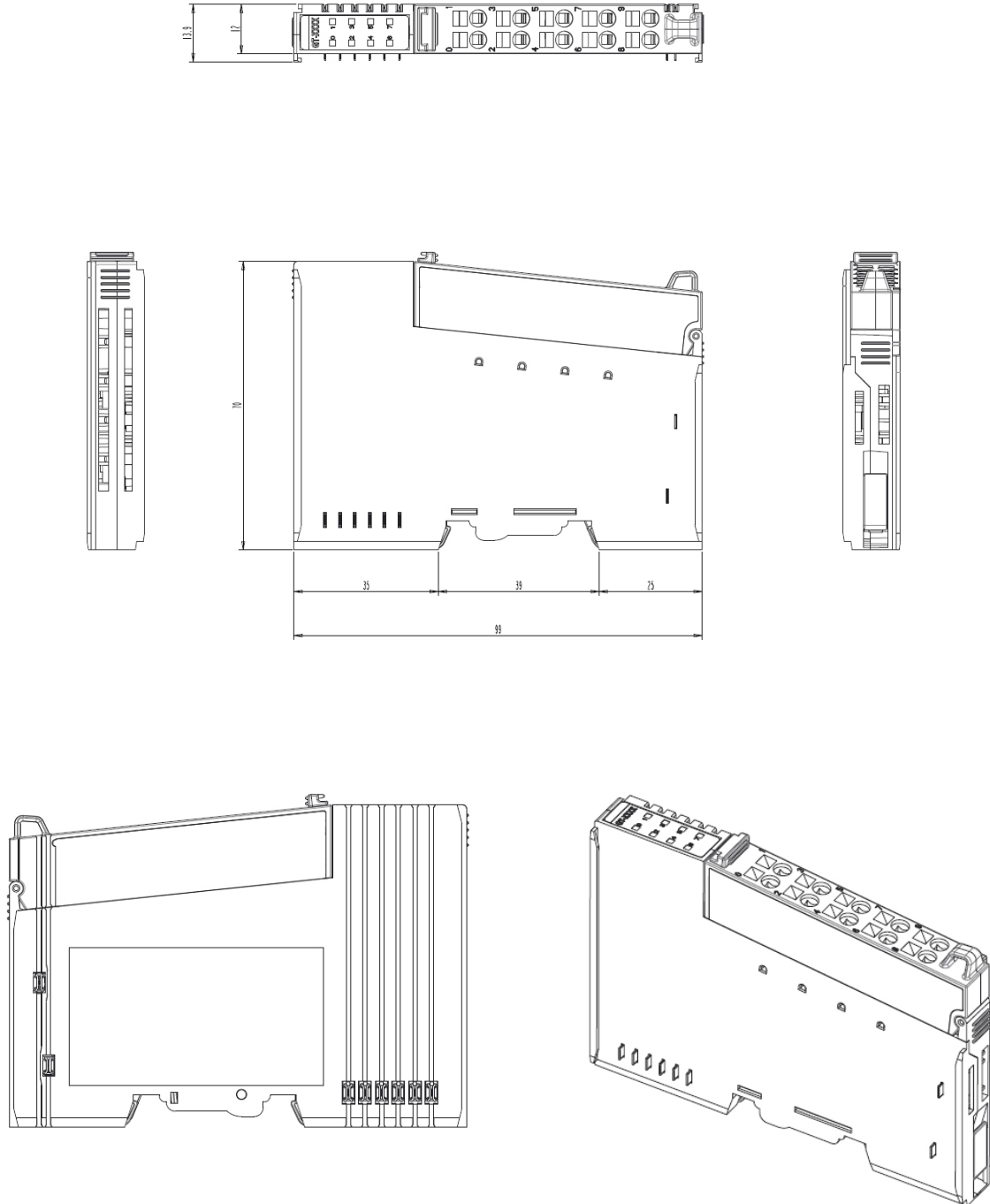

Dimensions in mm

4.2 20-Pin Connector Type

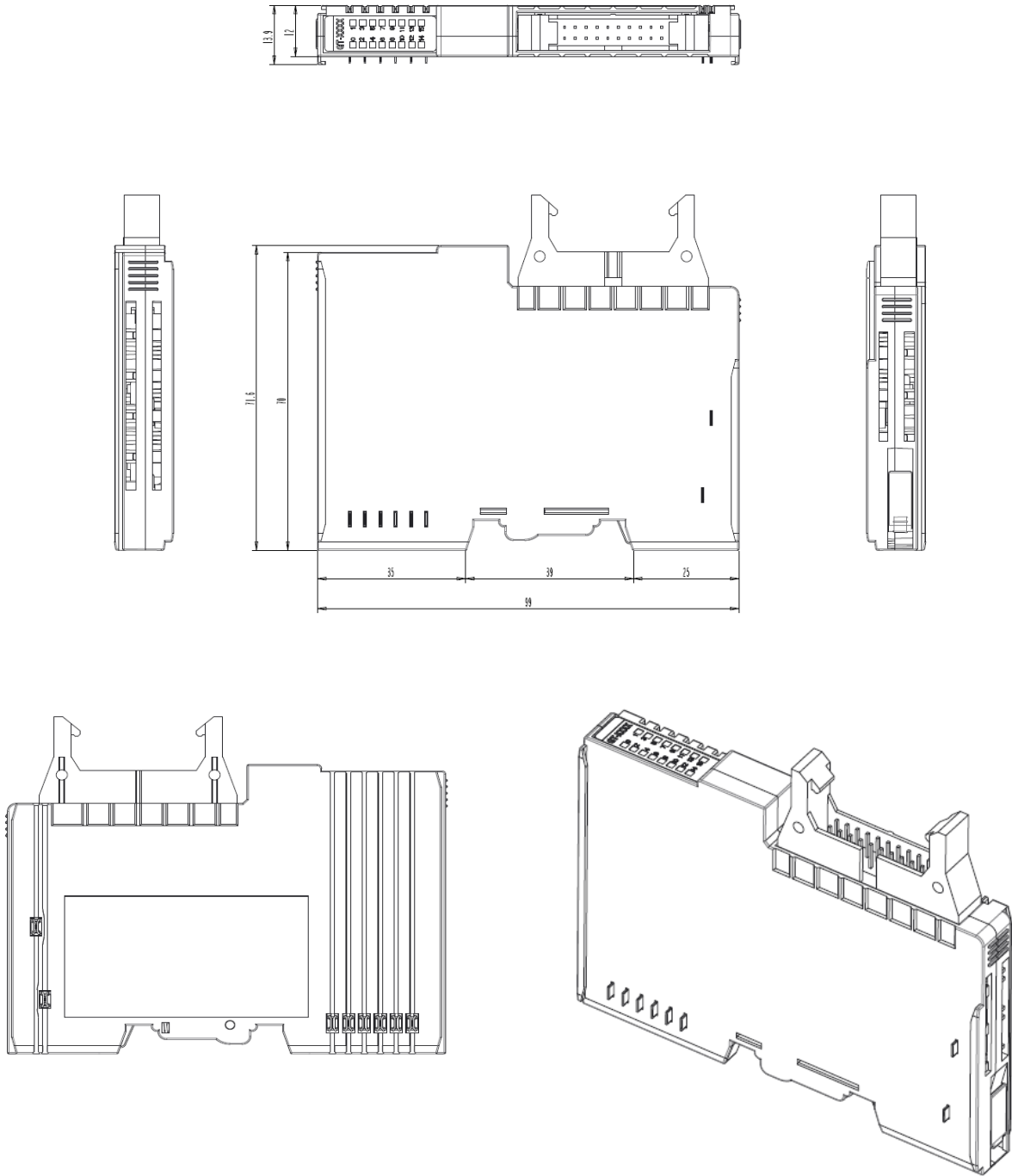

Dimensions in mm

4.3 18-Pts. Spring Type

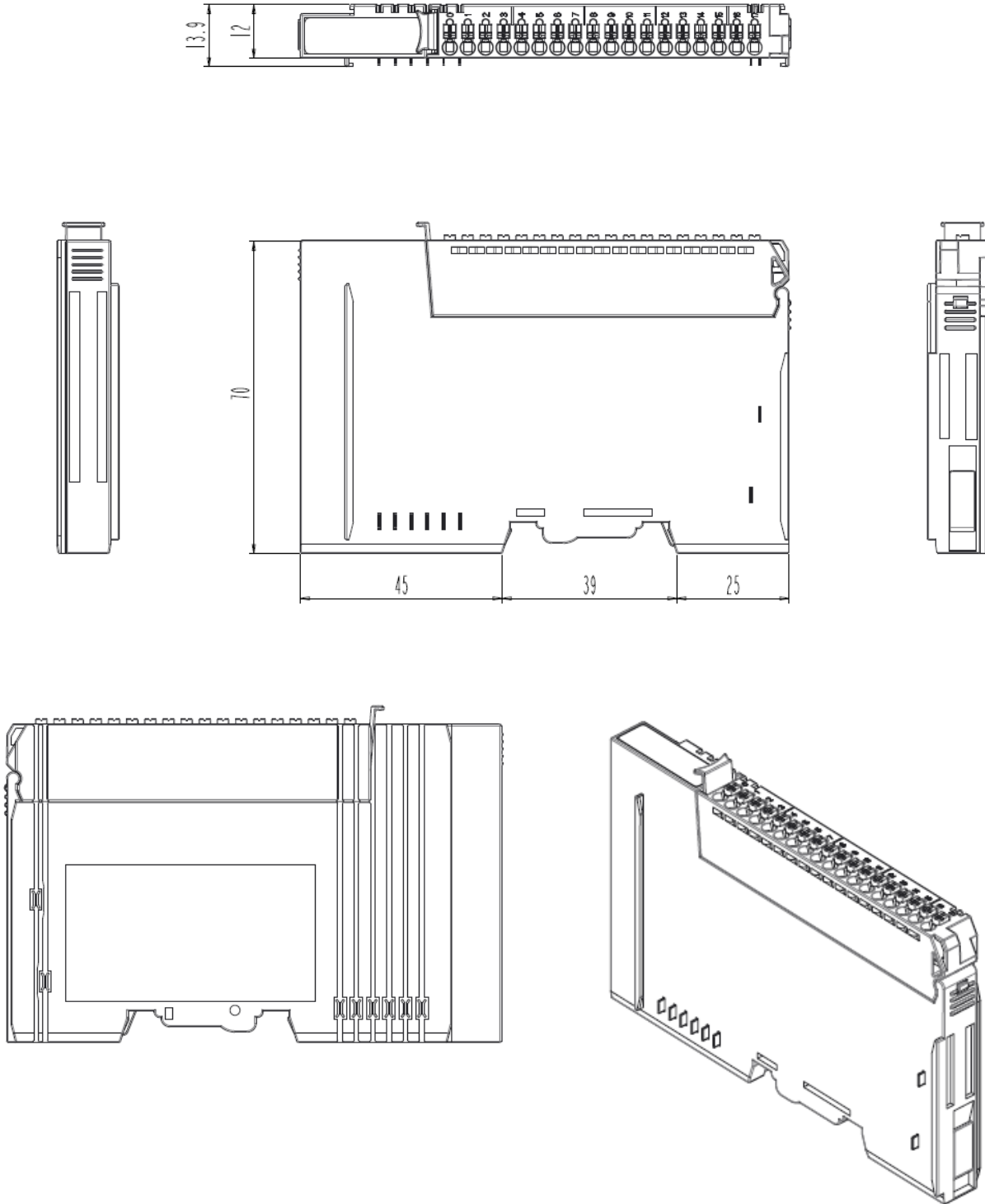

Dimensions in mm

5 Mounting

Caution!

Hot surface!

The surface of the housing can become hot during operation. If the device was operated at high ambient temperatures, allow it to be cool before touching it.

Notice!

Perform work on devices only if they are de-energized!

Working on energized devices can damage them. Therefore, turn off the power supply before working on the devices.

5.1 I/O Inserting and Removing Devices

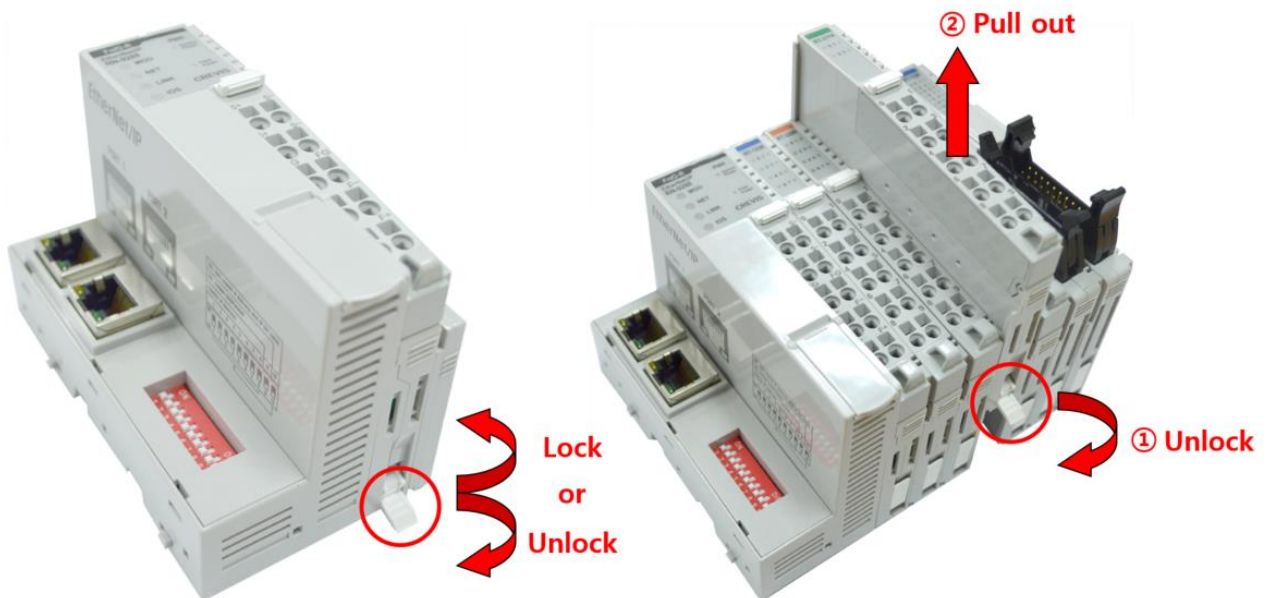

As above figure in order to safeguard the RIO3-Series module from jamming, it should be fixed onto the DIN rail with locking lever. To do so, fold on the upper of the locking lever.

To pull out the RIO3-Series module, unfold the locking lever as below figure.

5.2 RTB (Removable Terminal Block)

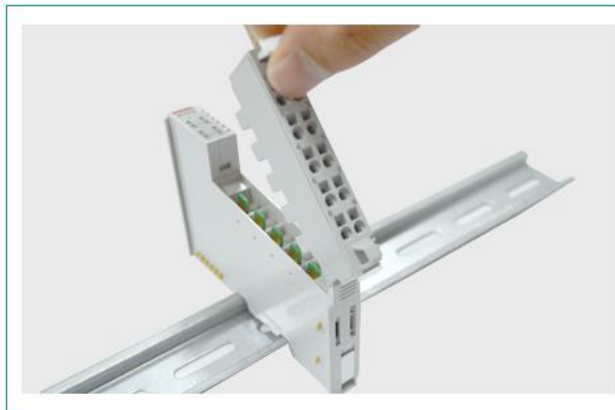
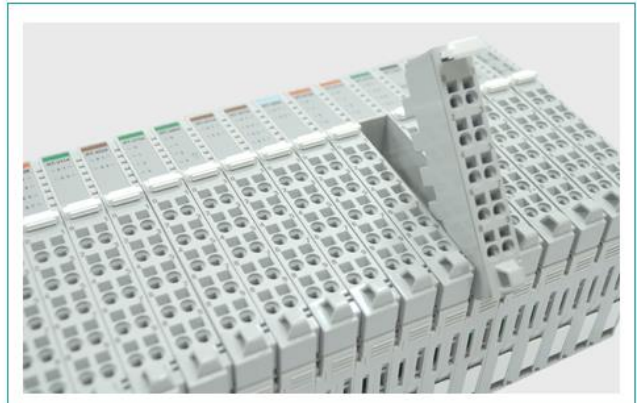
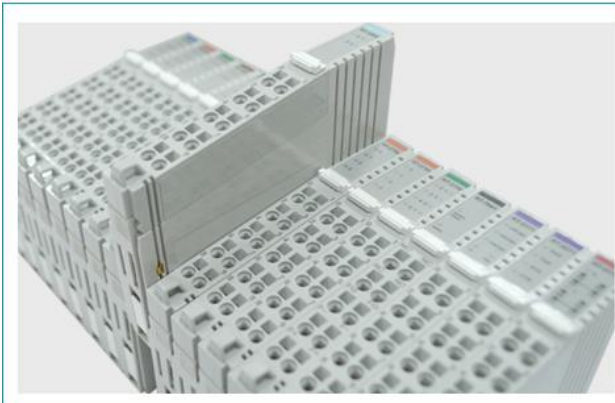

Whole terminal block can be combined and removed for the convenience.

There is a locking switch on the RTB for the easy combination and easy removal.

Easy combination and easy removal for IO modules on the din rail through One Touch Locking Switch.

6 Bus Pin Description

Communication between the Network Adapter and the expansion module as well as system / field power supply of the bus modules is carried out via the internal bus. It is comprised of 6 data pin and 2 field power pin.



*Please refer to the table below regarding the pin description from P1 to P8.

No.	Description
P1	System Power (VCC)
P2	System Power (GND)
P3	GBUS TX +
P4	GBUS TX -
P5	GBUS RX +
P6	GBUS RX -
P7	Field Power (GND)
P8	Field Power (VCC)

DANGER



Do not touch data and field power pins in order to avoid soiling and damage by ESD noise.

7 APPENDIX

7.1 Product List

No.	RIO3-Number	Description	ID (hex)
Digital Input Module			
01	RIO3-XDP8	8 Points, Universal, 24Vdc, 10RTB	1238
02	RIO3-XDP16C	16 Points, Universal, 24Vdc, 20P connector	123F
03	RIO3-XDP16T	16 Points, Universal, 24Vdc, 18RTB	12DF
04	RIO3-XDP32C	32 Points, Universal, 24Vdc, 40P connector	12FA
05	RIO3-XY16T	8 Sink Input / 8 Source Output with Diagnostic, 24Vdc	1428
06	RIO3-XAH4	4 Points, 240Vac, 10RTB	1904
Digital Output Module			
07	RIO3-YTP8	8 Points, Source, 24Vdc/0.5A, 10RTB	2328
08	RIO3-YTP16C	16 Points, Source, 24Vdc/0.3A, 20P connector	222F
09	RIO3-YTP16T	16 Points, Source, 24Vdc/0.3A, 18RTB	226F
10	RIO3-YTP32C	32 Points, Source, 24Vdc/0.3A, 40P connector	22CA
11	RIO3-YS4	4 Points, MOS Relay, 240Vdc/ac, 0.5A, 10RTB	2734
12	RIO3-YS8	8 Points, MOS Relay Output Terminal, 240Vdc, 0.5A	2738
13	RIO3-YR4	4 Points, Relay, 24Vdc/2A, 240Vac/2A, 10RTB	2744
Analog Input Module			
14	RIO3-LDC2	2ch load cell input unit, strain gauge	3002
15	RIO3-AX4I	4 Channels, 0~20, 4~20mA, 12bits, 10RTB	3114
16	RIO3-AXH4I	4 Channels, 0~20, 4~20mA, 16bits, 10RTB	3154
17	RIO3-AX8I	8 Channels, 0~20, 4~20mA, 12bits, 10RTB	3118
18	RIO3-AXH8I	8 Channels, 0~20, 4~20mA, 16bits, 10RTB	3158
19	RIO3-AX16IC	16 Channels, 0~20, 4~20mA, 12bits, 20P connector	311F
20	RIO3-AX16IT	16 Channels, 0~20, 4~20mA, 12bits, 18RTB	317F
21	RIO3-AX4V	4 Channels, 0~10, 0~5, 1~5Vdc, 12bits, 10RTB	3424
22	RIO3-AXH4V	4 Channels, 0~10, 0~5, 1~5Vdc, 16bits, 10RTB	3464
23	RIO3-AX8V	8 Channels, 0~10, 0~5, 1~5Vdc, 12bits, 10RTB	3428
24	RIO3-AXH8V	8 Channels, 0~10, 0~5, 1~5Vdc, 16bits, 10RTB	3468
25	RIO3-AX16VC	16 Channels, 0~10, 0~5, 1~5Vdc, 12bits, 20P connector	342F
26	RIO3-AX16VT	16 Channels, 0~10, 0~5, 1~5Vdc, 12bits, 18RTB	347F
27	RIO3-RTD4T	4 Channels, RTD, 10RTB	3704
28	RIO3-RTD8C	8 Channels, RTD, 20P connector	3708
29	RIO3-TC4T	4 Channels, Thermocouple, 10RTB	3804
30	RIO3-E3AC	AC Measurement	3901
Analog Output Module			
31	RIO3-AY4I	4 Channels, Current Output, 4~20mA, 12bits	4214
32	RIO3-AYH4I	4 Channels, Current Output, 4~20mA, 16bits	4254

33	RIO3-AY8I	8 CHANNELS CURRENT OUTPUT, 4~20mA, 12BIT	4218
34	RIO3-AY4V	4CH, 0~10Vdc, 12Bits, 10RTB	4424
35	RIO3-AYH4V	4CH, 0~10Vdc, 16Bits, 10RTB	4464
36	RIO3-AY8V	8CH, 0~10Vdc, 12Bits, 10RTB	4428
37	RIO3-AY16VC	16CH, 0~10Vdc, 12Bits, 20P Connector	442F
38	RIO3-AY16VT	16CH, 0~10Vdc, 12Bits, 18RTB	447F
Special Module			
39	RIO3-CU24L	High Speed Counter, 2CHs, 24Vdc, Encoder Input, 10RTB	
40	RIO3-RS232	1CH, RS 232, RTS/CTS, Full Duplex Type, 10RTB	5211
41	RIO3-RS485	1CH, RS 485, Half Full Duplex Type, 10RTB	5231
42	RIO3-PWM2	PWM Output, 2CHs, 0.5A/24Vdc, Source, 18RTB	5442
43	RIO3-PO2	Pulse Output, 2CHs, 0.5A/24Vdc, Source, 18RTB	5642
Power Module			
44	RIO3-SHD	Shield Module	7408
45	RIO3-0VDC	Common for 0Vdc	7508
46	RIO3-PSD	Power Expansion, In 24Vdc, Out 1A/5Vdc	7511
47	RIO3-24VDC	Common for 24Vdc	7518
48	RIO3-VDC	Common for 0Vdc, 24Vdc	7588
49	RIO3-PS	Field Power, 5/24/48 Vdc, 110/220 Vac	7641

7.2 Glossary

System Power: The power for starting up CPU.

Field Power: The power for input and output line.

Terminator Resistor: Resistor for prevention reflected wave.

EDS: Electronic Data Sheet.

Sink: The method of in/output power supply if a device has no power source.

Source: The method of in/output power supply if a device has the power source.