

# OPTIDRIVE™

AC Variable Speed Drive

Powerful Performance  
Advanced motor control



0.75kW – 250kW / 1HP – 350HP  
**200–600V** Single & 3 Phase Input

# Powerful Performance

World leading control for the latest generation of permanent magnet and standard induction motors

Manufacturing Pumping Conveyer Systems Machine Tools Processing Plants Chemical Rubber Elevators Cranes



## World Leading Motor Control

The Optidrive P2 offers the perfect combination of high performance together with ease of use to allow even the most demanding applications to be tackled easily.

Designed for fast installation and commissioning, Optidrive P2 provides the most cost effective solution for industry.

All Optidrive P2 units provide 150% overload for 60 seconds as standard, ensuring each drive is suitable for Heavy Duty applications, whilst the IP55 enclosed versions ensure the drive is tough enough to survive in industrial environments.

Extensive I/O and communications interface capabilities ensure the drive can be integrated quickly and efficiently into a wide variety of control systems with the minimum commissioning time, ensuring rapid start up. Invertertek's simple parameter structure, and carefully selected factory parameter settings ensure that commissioning time is kept to a minimum.



Compliant with international standards.  
Manufactured in the UK.

# 150% overload for 60 seconds



**IP20**

Up to 250kW



**IP55**

Up to 160kW



**IP66**

Up to 11kW

## Advanced Motor Control

Optidrive P2 has been uniquely developed to allow a wide range of different motor types to be used, with only parameter changes being required. This technology allows the same drive to be used in a wide range of applications, allowing OEMs and end user alike to take advantage of the energy saving provided by using the latest motor technologies.

### AC Induction Motors

The majority of AC motors in use today around the world are standard induction motors. These motors are relatively low cost, readily available and provide good performance with long service life. With the ever increasing focus on energy efficiency, motor manufacturers have refined and improved their designs in recent years.

Optidrive P2 has been developed to provide optimum control and maximum efficiency when operating with older motors designs, or newer high efficiency designs.

Operation can be in simple V/F control mode or in High Performance Third Generation Vector Mode, which provides up to 200% torque from zero speed without requiring an encoder.

### Permanent Magnet AC Motors

Permanent magnet AC motors provide improved efficiency compared to standard induction motors. Using permanent magnets in the motor construction eliminates the need for any magnetising current, reducing electrical losses. PM motors have been used for many years in high performance applications, however this has always required the use of a feedback device, such as a resolver or encoder. Optidrive P2 has been designed to operate with AC PM motors without requiring any feedback device, allowing them to be used for their energy efficiency benefits without incurring extra cost and complexity in applications which do not require position feedback.

### Brushless DC Motors

BLDC motors are similar to AC PM motors, however the design requires a slightly different control method to optimise the performance. Optidrive P2 has the flexibility to control this type of motor, requiring only simple parameter changes. This provides much greater flexibility for OEMs, allowing Optidrive P2 to be used in a variety of applications, with various motor types.

### Synchronous Reluctance Motors

Synchronous Reluctance Motors (SynRM), not to be confused with Switched Reluctance Motors, share a similar stator construction to standard induction motors, however the rotor is substantially different, in order to improve the overall efficiency of the motor. SynRM motors are ideally suited to variable torque applications.

Optidrive P2 can control synchronous reluctance motors, allowing the energy saving benefits to be realised.

# At a Glance...

High performance, excellent usability and flexible to meet the needs of your application

Keyhole  
Mounts for fast  
installation



IP55 / NEMA 12

Select Language  
Español  
Deutsch  
▶ English

Integrated  
Keypad & Display  
(LED or Multi-language  
Text Display)

Integrated  
EMC Filter

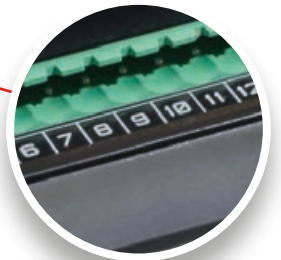

Pluggable Control  
Terminals



High Quality  
Long-life Fans

Integral  
Brake  
Transistor



Integrated Cable  
Management



Contactor-style Power Wiring Arrangement

Keyhole Mounts for fast installation

DIN Rail Mount

Convenient Reference Card

Modbus RTU and CANopen on board as standard

Modbus CANopen

**Safe Torque Off** (provided as standard)

Optidrive P2 features a safe torque off function to allow simple integration into machine critical safety circuits.

- Simple machine design reduces component costs, saves panel space and minimises installation time
- Faster shut down and reset procedures reduce system maintenance time
- Better safety standard compared to mechanical solution
- Better motor connection. Single cable with no interruption.



**With**

**Without**

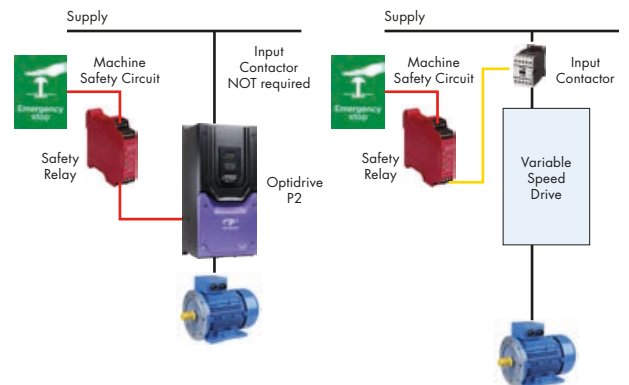

# Applications

High performance, accurate motor control for even the most demanding of applications



## Mining & Quarrying

- Feed conveyers
- Crushers
- Cranes

## Metals & Processing

- Grinding
- Cutting
- Polishing
- Drilling
- Rolling

## Rubber & Plastics

- Extruders
- Moulding
- Mixers
- Winding

## Food & Beverage

- Conveyers
- Pumps
- Mixers
- Palletisers

Powerful, versatile and  
easy to use

## Cranes



### Requirements:

- High starting torque
- Smooth motor operation throughout starting and stopping phases
- Motor holding brake control
- Avoidance of load droop and sag
- Regeneration and braking capability during load lowering

### Optidrive P2 provides:

- Dedicated Hoist Mode Operation with motor holding brake control algorithm
- Up to 200% torque from zero speed in vector operation without encoder feedback
- Multiple Preset Speed or variable speed operation
- Built in dynamic braking transistor, requires only an external resistor

## Compressors



### Requirements:

- Precise regulation of speed to ensure a consistent end product
- High starting torque demand in many applications
- Maximum efficiency under all conditions
- Safe operation to prevent accidents and injuries

### Optidrive P2 Provides:

- PM Motor control mode to allow open loop operation with Permanent Magnet motors for maximum efficiency
- Maximum starting torque with standard AC motors
- Better than 0.5% speed holding accuracy in Open Loop Vector Operation
- Dedicated Safe Torque Off input complies with EN62061 SIL Level 2 for safe operation

## Winding



### Requirements:

- Precise control of motor torque over a broad speed range
- Accurate control of material tension under all conditions
- Open or closed loop control capability, based on tension feedback or winding diameter
- Web break protection in case of material breakage

### Optidrive P2 Provides:

- PID Closed Loop Tension Control with feedback from a load cell or dancer arm
- Open Loop Vector control provides optimum tension control of the output torque level
- Encoder feedback option allows for a very wide speed range, even down to zero speed
- Safe Torque Off input immediately disables the drive in Emergency conditions

# Options & Accessories

Installation options, plug-in modules and commissioning tools



## Fieldbus Interfaces

## Plug-in Options

Modbus RTU and CANopen on board as standard

For additional communication interfaces or functionality a range of plug-in modules is available:



**Profibus DP**  
OPT-2-PROFB-IN



**DeviceNet**  
OPT-2-DEVNT-IN



**Ethernet IP**  
OPT-2-ETHNT-IN



**Modbus TCP**  
OPT-2-MODIP-IN



**Profinet**  
OPT-2-PFNET-IN



**EtherCat**  
OPT-2-ETCAT-IN



**Encoder Feedback**  
OPT-2-ENCOD-IN (5 Volt)  
OPT-2-ENCHT-IN (15 – 30 Volt)

Closed loop encoder feedback, compatible with a wide range of incremental encoders

**Extended I/O**  
OPT-2-EXTIO-IN

- Additional 3 Digital Inputs
- Additional Relay Output

**Extended Relay**  
OPT-2-CASCD-IN

Additional 3 Relay Outputs:

- Relay 3** – Drive Healthy Indication
- Relay 4** – Drive Fault Indication
- Relay 5** – Drive Running Indication

Functions are programmable / adjustable



# Installation & Peripheral Options

A range of external EMC Filters, Brake Resistors, Input Chokes and Output Filters are available, to suit all installation requirements

## Optistick Smart



NFC

Bluetooth®

### Rapid Commissioning Tool

- Allows copying, backup and restore of drive parameters
- Provides Bluetooth interface to a PC running OptiTools Studio or the OptiTools Mobile app on a smartphone
- Onboard NFC (Near Field Communication) for rapid data transfer

OPT-3-STICK-IN

## OptiTools Studio

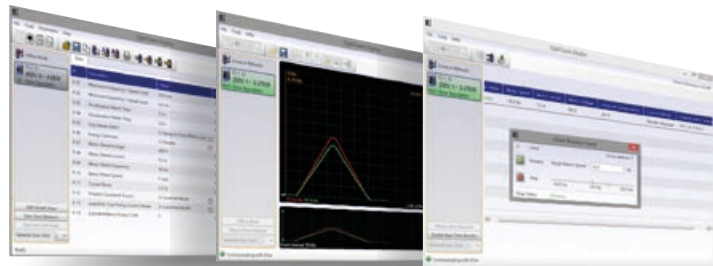

### Powerful PC Software

#### Drive commissioning and parameter backup

- Real-time parameter editing
- Drive network communication
- Parameter upload, download and storage
- Simple PLC function programming
- Real-time scope function and data logging
- Real-time data monitoring

#### Compatible with:

Windows Vista  
Windows 7  
Windows 8  
Windows 8.1  
Windows 10

**Replace #** in model code with enclosure/display option

Input Voltage	Frame Size			kW	HP	Amps	kW Model Code							HP Model Code							Display												
	IP20	IP55	IP66				Product Family	Generation	Frame Size	Voltage Code	Power Rating Code	Supply Phases	Power Type	EMC Filter	Brake Transistor	Product Family	Generation	Frame Size	Voltage Code	Power Rating Code	Supply Phases	Power Type	EMC Filter	Brake Transistor	IP20	IP20	IP55	IP66	IP66				
																									LED Display	TFT Display	OLED Display	TFT Display	Switched TFT Display				
200–240V ± 10% 1 Phase Input	2	2		0.75	1	4.3	ODP - 2 - 2 2 075 - 1 K F 4 #	ODP - 2 - 2 2 010 - 1 H F 4 #																	2-SN		A-MN	B-MN					
	2	2		1.5	2	7	ODP - 2 - 2 2 150 - 1 K F 4 #	ODP - 2 - 2 2 020 - 1 H F 4 #																	2-SN		A-MN	B-MN					
	2	2		2.2	3	10.5	ODP - 2 - 2 2 220 - 1 K F 4 #	ODP - 2 - 2 2 030 - 1 H F 4 #																	2-SN		A-MN	B-MN					
200–240V ± 10% 3 Phase Input	2	2		0.75	1	4.3	ODP - 2 - 2 2 075 - 3 K F 4 #	ODP - 2 - 2 2 010 - 3 H F 4 #																			2-SN		A-MN	B-MN			
	2	2		1.5	2	7	ODP - 2 - 2 2 150 - 3 K F 4 #	ODP - 2 - 2 2 020 - 3 H F 4 #																			2-SN		A-MN	B-MN			
	2	2		2.2	3	10.5	ODP - 2 - 2 2 220 - 3 K F 4 #	ODP - 2 - 2 2 030 - 3 H F 4 #																			2-SN		A-MN	B-MN			
	3	3		4	5	18	ODP - 2 - 3 2 040 - 3 K F 4 #	ODP - 2 - 3 2 050 - 3 H F 4 #																						2-SN		A-MN	B-MN
	3			5.5	7.5	24	ODP - 2 - 3 2 055 - 3 K F 4 #	ODP - 2 - 3 2 075 - 3 H F 4 #																			2-SN						
		4		5.5	7.5	24	ODP - 2 - 4 2 055 - 3 K F 4 #	ODP - 2 - 4 2 075 - 3 H F 4 #																									
	4	4		7.5	10	30	ODP - 2 - 4 2 075 - 3 K F 4 #	ODP - 2 - 4 2 100 - 3 H F 4 #																									
	4	4		11	15	46	ODP - 2 - 4 2 110 - 3 K F 4 #	ODP - 2 - 4 2 150 - 3 H F 4 #																									
	5	5		15	20	60	ODP - 2 - 5 2 150 - 3 K F 4 #	ODP - 2 - 5 2 020 - 3 H F 4 #																									
	5	5		18.5	25	72	ODP - 2 - 5 2 185 - 3 K F 4 #	ODP - 2 - 5 2 025 - 3 H F 4 #																									
	6A	6		22	30	90	ODP - 2 - 6 2 022 - 3 K F 4 #	ODP - 2 - 6 2 030 - 3 H F 4 #																									
	6A	6		30	40	110	ODP - 2 - 6 2 030 - 3 K F 4 #	ODP - 2 - 6 2 040 - 3 H F 4 #																									
	6B	6		37	50	150	ODP - 2 - 6 2 037 - 3 K F 4 #	ODP - 2 - 6 2 050 - 3 H F 4 #																									
	6B	6		45	60	180	ODP - 2 - 6 2 045 - 3 K F 4 #	ODP - 2 - 6 2 060 - 3 H F 4 #																									
		7		55	75	202	ODP - 2 - 7 2 055 - 3 K F 4 #	ODP - 2 - 7 2 075 - 3 H F 4 #																									
	7		75	100	240	ODP - 2 - 7 2 075 - 3 K F 4 #	ODP - 2 - 7 2 100 - 3 H F 4 #																										
380–480V ± 10% 3 Phase Input	2	2		0.75	1	2.2	ODP - 2 - 2 4 075 - 3 K F 4 #	ODP - 2 - 2 4 010 - 3 H F 4 #																									
	2	2		1.5	2	4.1	ODP - 2 - 2 4 150 - 3 K F 4 #	ODP - 2 - 2 4 020 - 3 H F 4 #																									
	2	2		2.2	3	5.8	ODP - 2 - 2 4 220 - 3 K F 4 #	ODP - 2 - 2 4 030 - 3 H F 4 #																									
	2	2		4	5	9.5	ODP - 2 - 2 4 400 - 3 K F 4 #	ODP - 2 - 2 4 050 - 3 H F 4 #																									
	3	3		5.5	7.5	14	ODP - 2 - 3 4 055 - 3 K F 4 #	ODP - 2 - 3 4 075 - 3 H F 4 #																									
	3	3		7.5	10	18	ODP - 2 - 3 4 075 - 3 K F 4 #	ODP - 2 - 3 4 100 - 3 H F 4 #																									
	3			11	15	24	ODP - 2 - 3 4 110 - 3 K F 4 #	ODP - 2 - 3 4 150 - 3 H F 4 #																									
		4		11	15	24	ODP - 2 - 4 4 110 - 3 K F 4 #	ODP - 2 - 4 4 150 - 3 H F 4 #																									
	4	4		15	20	30	ODP - 2 - 4 4 150 - 3 K F 4 #	ODP - 2 - 4 4 200 - 3 H F 4 #																									
	4	4		18.5	25	39	ODP - 2 - 4 4 185 - 3 K F 4 #	ODP - 2 - 4 4 250 - 3 H F 4 #																									
	4	4		22	30	46	ODP - 2 - 4 4 220 - 3 K F 4 #	ODP - 2 - 4 4 300 - 3 H F 4 #																									
	5	5		30	40	61	ODP - 2 - 5 4 300 - 3 K F 4 #	ODP - 2 - 5 4 040 - 3 H F 4 #																									
	5	5		37	50	72	ODP - 2 - 5 4 370 - 3 K F 4 #	ODP - 2 - 5 4 050 - 3 H F 4 #																									
	6A	6		45	60	90	ODP - 2 - 6 4 045 - 3 K F 4 #	ODP - 2 - 6 4 060 - 3 H F 4 #																									
	6A	6		55	75	110	ODP - 2 - 6 4 055 - 3 K F 4 #	ODP - 2 - 6 4 075 - 3 H F 4 #																									
	6B	6		75	100	150	ODP - 2 - 6 4 075 - 3 K F 4 #	ODP - 2 - 6 4 100 - 3 H F 4 #																									
	6B	6		90	150	180	ODP - 2 - 6 4 090 - 3 K F 4 #	ODP - 2 - 6 4 150 - 3 H F 4 #																									
	7		110	175	202	ODP - 2 - 7 4 110 - 3 K F 4 #	ODP - 2 - 7 4 175 - 3 H F 4 #																										
	7		132	200	240	ODP - 2 - 7 4 132 - 3 K F 4 #	ODP - 2 - 7 4 200 - 3 H F 4 #																										
	7		160	250	302	ODP - 2 - 7 4 160 - 3 K F 4 #	ODP - 2 - 7 4 250 - 3 H F 4 #																										
	8		200	300	370	ODP - 2 - 8 4 200 - 3 K F 4 #	ODP - 2 - 8 4 300 - 3 H F 4 #																										
	8		250	350	450	ODP - 2 - 8 4 250 - 3 K F 4 #	ODP - 2 - 8 4 350 - 3 H F 4 #																										
480–525V ± 10% 3 Phase Input	7			132	–	185	ODP - 2 - 7 5 132 - 3 K 0 4 #	–																									
	7			150	–	205	ODP - 2 - 7 5 150 - 3 K 0 4 #	–																									
	7			185	–	255	ODP - 2 - 7 5 185 - 3 K 0 4 #	–																									
	7			200	–	275	ODP - 2 - 7 5 200 - 3 K 0 4 #	–																									
500–600V ± 10% 3 Phase Input	2	2		0.75	1	2.1	ODP - 2 - 2 6 075 - 3 K 0 4 #	ODP - 2 - 2 6 010 - 3 H 0 4 #																									
	2	2		1.5	2	3.1	ODP - 2 - 2 6 150 - 3 K 0 4 #	ODP - 2 - 2 6 020 - 3 H 0 4 #																									
	2	2		2.2	3	4.1	ODP - 2 - 2 6 220 - 3 K 0 4 #	ODP - 2 - 2 6 030 - 3 H 0 4 #																									
	2	2		4	5	6.5	ODP - 2 - 2 6 400 - 3 K 0 4 #	ODP - 2 - 2 6 050 - 3 H 0 4 #																									
	2	2		5.5	7.5	9	ODP - 2 - 2 6 550 - 3 K 0 4 #	ODP - 2 - 2 6 075 - 3 H 0 4 #																									
	3	3		7.5	10	12	ODP - 2 - 3 6 075 - 3 K 0 4 #	ODP - 2 - 3 6 100 - 3 H 0 4 #																									
	3	3		11	15	17	ODP - 2 - 3 6 110 - 3 K 0 4 #	ODP - 2 - 3 6 150 - 3 H 0 4 #																									
	3			15	20	22	ODP - 2 - 3 6 150 - 3 K 0 4 #	ODP - 2 - 3 6 200 - 3 H 0 4 #																									
		4		15	20	22	ODP - 2 - 4 6 150 - 3 K 0 4 #	ODP - 2 - 4 6 200 - 3 H 0 4 #																									
	4	4		18.5	25	28	ODP - 2 - 4 6 185 - 3 K 0 4 #	ODP - 2 - 4 6 250 - 3 H 0 4 #																									
	4	4		22	30	34	ODP - 2 - 4 6 220 - 3 K 0 4 #	ODP - 2 - 4 6 300 - 3 H 0 4 #																									
	4	4		30	40	41	ODP - 2 - 4 6 300 - 3 K 0 4 #	ODP - 2 - 4 6 400 - 3 H 0 4 #																									
	5	5		37	50	54	ODP - 2 - 5 6 370 - 3 K 0 4 #	ODP - 2 - 5 6 050 - 3 H 0 4 #																									
	5	5		45	60	65	ODP - 2 - 5 6 450 - 3 K 0 4 #	ODP - 2 - 5 6 060 - 3 H 0																									

## Drive Specification

Input Ratings	Supply Voltage	200 – 240V ± 10% 380 – 480V ± 10% 500 – 600V ± 10%		
	Supply Frequency	48 – 62Hz		
	Displacement Power Factor	> 0.98		
	Phase Imbalance	3% Maximum allowed		
	Inrush Current	< rated current		
	Power Cycles	120 per hour maximum, evenly spaced		
	Output Ratings	Output Power	230V 1Ph. Input: 0.75–2.2kW (1–3HP) 230V 3Ph. Input: 0.75–75kW (1–100HP) 400V 3Ph. Input: 0.75–250kW 460V 3Ph. Input: 1–350HP 575V 3Ph. Input: 0.75–110kW (1–150HP)	
Overload Capacity		150% for 60 seconds		
Output Frequency		0 – 500Hz, 0.1Hz resolution		
Acceleration Time		0.01 – 600 seconds		
Deceleration Time		0.01 – 600 seconds		
Typical Efficiency		> 98%		
Ambient Conditions		Temperature	Storage: –40 to 60°C Operating: –10 to 50°C	
		Altitude	Up to 1000m ASL without derating Up to 2000m maximum UL Approved Up to 4000m maximum (non UL)	
		Vibration	Conforms to IEC 60068-2-6 Sinusoidal Vibration 10 - 57Hz @ 0.075mm Pk 57 - 150Hz @ 1g Pk	
Enclosure		Ingress Protection	IP20, IP55, IP66	
	Programming	Keypad	Built-in keypad as standard Optional remote mountable keypad	
Display		Built-in multi language text display (IP55 & IP66) 7 Segment LED (IP20)		
PC		OptiTools Studio		
Control Specification	Control Method	V/F Voltage Vector Energy Optimised V/F 3GV Sensorless Vector Speed Control 3GV Sensorless Vector Torque Control Closed Loop (Encoder) Speed Control Closed Loop (Encoder) Torque Control PM Vector Control BLDC Control Synchronous Reluctance		
		PWM Frequency	4–32kHz Effective	
		Stopping Mode	Ramp to Stop: User Adjustable 0.01 – 600 secs Coast to Stop	
		Braking	Motor Flux Braking Built-in Braking Transistor	
		Skip Frequency	Single point, user adjustable	
	Setpoint Control	Analog Signal	0 to 10 Volts 10 to 0 Volts –10 to +10 Volts 0 to 20mA 20 to 0mA 4 to 20mA 20 to 4mA	
			Digital	Motorised Potentiometer (Keypad) Modbus RTU CANopen

Fieldbus Connectivity	Builtin	CANopen 125 – 1000kbps Modbus RTU 9.6 - 115.2 kbps selectable 8N1, 8N2, 8E1, 8O1	
	Optional	PROFIBUS DP (DPV1) PROFINET IO DeviceNet EtherNet/IP EtherCAT Modbus TCP	
I/O Specification	Power Supply	24 Volt DC, 100mA, Short Circuit Protected 10 Volt DC, 10mA for Potentiometer	
	Programmable Inputs	5 Total as standard (Optional additional 3) 3 Digital (Optional additional 3) 2 Analog / Digital Selectable	
	Digital Inputs	Opto - Isolated 8 – 30 Volt DC, internal or external supply Response time < 4ms	
	Analog Inputs	Resolution: 12 bits Response time: < 4ms Accuracy: < 1% full scale Parameter adjustable scaling and offset	
	PTC Input	Motor PTC / Thermistor Input Trip Level : 3kΩ	
	Programmable Outputs	4 Total (Optional additional 3) 2 Analog / Digital 2 Relays (Optional additional 3)	
	Relay Outputs	Maximum Voltage: 250 VAC, 30 VDC Switching Current Capacity: 5A AC , 5A DC	
	Analog Outputs	0 to 10 Volt 0 to 20mA 4 to 20mA	
	Application Features	PID Control	Internal PID Controller Multi Setpoint Select Standby / Sleep Mode Boost Function
		Hoist Mode	Dedicated Hoist Mode Motor Holding Brake Pre-Torque & Control Over Limit Protection
Maintenance & Diagnostics	Fault Memory	Last 4 Trips stored with time stamp	
	Data Logging	Logging of data prior to trip for diagnostic purposes: Output Current Drive Temperature DC Bus Voltage	
	Maintenance Indicator	Maintenance Indicator with user adjustable maintenance interval Onboard service life monitoring	
	Monitoring	Hours Run Meter Resettable & Non Resettable kWh meters Cooling Fan Run Time	
Standards Compliance	Low Voltage Directive	2014/35/EU	
	EMC Directive	2014/30/EU	
	Additional Conformance	UL, cUL, EAC, RCM	
	Marine Certification	DNV Type Approval	
	Environmental Conditions	Designed to meet IEC 60721-3-3, in operation: IP20 Drives: 3S2/3C2 IP55 & 66 Drives: 3S3/3C3	

## Model Code Guide

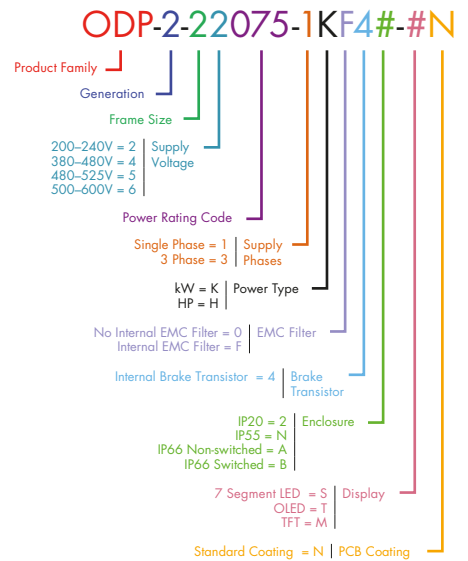

## Connection Diagram

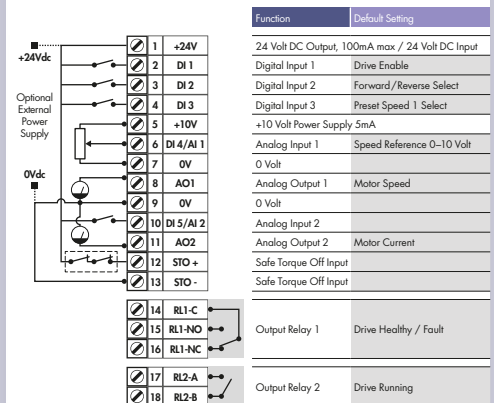

NOT TO SCALE



Size	IP20			IP66			IP55						
	2	3	4	5	6A	6B	8	2	3	4	5	6	7
mm Height	221	261	418	486	614	726	995	257	310	450	540	865	1280
mm Width	110	131	160	222	286	330	482	188	211	171	235	330	330
mm Depth	185	205	240	260	320	320	480	239	266	252	270	330	360
kg Weight	1.8	3.5	9.2	18.2	32	43	128	4.8	7.7	11.5	23	55	89

Invertek Drives Ltd is dedicated to the design, manufacture and marketing of electronic variable speed drives. The state of the art UK headquarters houses specialist facilities for research & development, manufacturing and global marketing. The company pledges to implement and operate the ISO 14001 Environmental Management System to enhance environmental performance.

All company operations are accredited to the exacting customer focused ISO 9001:2008 quality standard. The company's products are sold globally in over 80 different countries. Invertek Drives' unique and innovative drives are designed for ease of use and meet with recognised international design standards.



UK Headquarters, Welshpool

## Global Drive Solutions

Invertek Drives operate at the heart of automated systems around the world



**Crane Control**  
Demanding application at South African mine

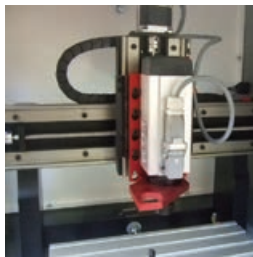

**Machine Tool OEM**  
UK machine tool supplier specifies Optidrive



**Film Manufacturing**  
Optimum tension control in Australia

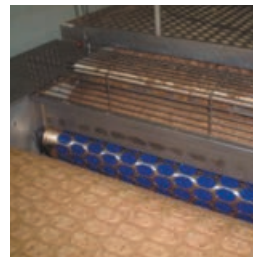

**Food Processing**  
Precision conveyor control in Spain



**Amusement Parks**  
Reliable control of difficult loads in Spain



### Optidrive P2 User Guide



Scan to download or visit the Invertek Drives website

[www.invertekdrives.com/optidrive-p2](http://www.invertekdrives.com/optidrive-p2)

#### INVERTEK DRIVES LIMITED UK Headquarters

Offa's Dyke Business Park  
Welshpool, Powys, UK  
SY21 8JF

**Tel:** +44 (0)1938 556868  
**Fax:** +44 (0)1938 556869  
**Email:** sales@invertekdrives.com

