



INVERTER

Plug-in option

FR-A7AX

INSTRUCTION MANUAL

16 bit digital input function

PRE-OPERATION INSTRUCTIONS

1

INSTALLATION AND WIRING

2

CONNECTION DIAGRAM AND TERMINAL

3

PARAMETERS

4

Thank you for choosing this Mitsubishi Inverter plug-in option. This instruction manual gives handling information and precautions for use of this equipment. Incorrect handling might cause an unexpected fault. Before using the equipment, please read this manual carefully to use the equipment to its optimum. Please forward this manual to the end user.

This section is specifically about safety matters

Do not attempt to install, operate, maintain or inspect this product until you have read through this instruction manual and appended documents carefully and can use the equipment correctly. Do not use this product until you have a full knowledge of the equipment, safety information and instructions.

In this instruction manual, the safety instruction levels are classified into "WARNING" and "CAUTION".



Assumes that incorrect handling may cause hazardous conditions, resulting in death or severe injury.



Assumes that incorrect handling may cause hazardous conditions, resulting in medium or slight injury, or may cause physical damage only.

Note that even the  **CAUTION** level may lead to a serious consequence according to conditions. Please follow the instructions of both levels because they are important to personnel safety.

SAFETY INSTRUCTIONS

1. Electric Shock Prevention

WARNING

- While power is on or when the inverter is running, do not open the front cover. You may get an electric shock.
- Do not run the inverter with the front cover or wiring cover removed. Otherwise, you may access the exposed high-voltage terminals and charging part and get an electric shock.
- If power is off, do not remove the front cover except for wiring or periodic inspection. You may access the charged inverter circuits and get an electric shock.
- Before starting wiring or inspection, check to make sure that Indication of the inverter operation panel is off, wait for at least 10 minutes after the power supply has been switched off, and check that there are no residual voltage using a tester or the like. The capacitor is charged with high voltage for some time after power off and it is dangerous.
- Any person who is involved in the wiring or inspection of this equipment should be fully competent to do the work.
- Always install the plug-in option before wiring. Otherwise, you may get an electric shock or be injured.
- Do not touch the plug-in option with wet hands. Otherwise you may get an electric shock.
- Do not subject the cables to scratches, excessive stress, heavy loads or pinching. Otherwise you may get an electric shock.

2. Injury Prevention

CAUTION

- Apply only the voltage specified in the instruction manual to each terminal. Otherwise, burst, damage, etc. may occur.
- Ensure that the cables are connected to the correct terminals. Otherwise, burst, damage, etc. may occur.
- Always make sure that polarity is correct to prevent damage, etc. Otherwise, burst, damage may occur.
- While power is on or for some time after power-off, do not touch the inverter as it is hot and you may get burnt.

3. Additional Instructions

Also note the following points to prevent an accidental failure, injury, electric shock, etc.

1) Transportation and mounting

CAUTION

- Do not install or operate the plug-in option if it is damaged or has parts missing.
- Do not stand or rest heavy objects on the product.
- Check that the mounting orientation is correct.
- Prevent other conductive bodies such as screws and metal fragments or other flammable substance such as oil from entering the inverter.

2) Trial run

CAUTION

- Before starting operation, confirm and adjust the parameters. A failure to do so may cause some machines to make unexpected motions.

3) Usage

WARNING

- Do not modify the equipment.
- Do not perform parts removal which is not instructed in this manual. Doing so may lead to fault or damage of the inverter.

CAUTION

- When parameter clear or all parameter clear is performed, reset the required parameters before starting operations. Each parameter returns to the initial value.
- For prevention of damage due to static electricity, touch nearby metal before touching this product to eliminate static electricity from your body.

4) Maintenance, inspection and parts replacement

CAUTION

- Do not test the equipment with a megger (measure insulation resistance).

5) Disposal

CAUTION

- Treat as industrial waste.

6) General instruction

All illustrations given in this manual may have been drawn with covers or safety guards removed to provide in-depth description. Before starting operation of the product, always return the covers and guards into original positions as specified and operate the equipment in accordance with the manual.

— CONTENTS —

1	PRE-OPERATION INSTRUCTIONS	1
1.1	Unpacking and Product Confirmation	1
1.1.1	Packing confirmation	1
1.1.2	Parts	2
1.1.3	Specifications	3
2	INSTALLATION AND WIRING	4
2.1	Pre-Installation Instructions	4
2.2	Installation Procedure	5
2.3	Wiring	7
3	CONNECTION DIAGRAM AND TERMINAL	9
3.1	Connection Diagram	9
3.2	Internal Block Diagram	11
3.3	Terminals	12
3.4	Code Input Example	13
4	PARAMETERS	14
4.1	Parameter List	14
4.2	Parameter Setting	16
4.2.1	Selection of input method (Pr. 304)	16
4.2.2	Data read timing signal on-off selection (Pr. 305)	18
4.2.3	Bias and gain adjustment (Pr. 300, Pr. 301, Pr. 302, Pr. 303)	20
4.2.4	Digital input increments selection (Pr. 329)	22
4.2.5	16 bit digital torque command (FR-A700 series only)	23
4.3	Instructions	27

1 PRE-OPERATION INSTRUCTIONS



1.1 Unpacking and Product Confirmation

Take the plug-in option out of the package, check the unit name, and confirm that the product is as you ordered and intact.

This product is a plug-in option dedicated for the FR-A700/F700 series.

1.1.1 Packing confirmation

Check the enclosed items.

<p>Plug-in option 1</p> 	<p>Mounting screw (M3 × 6mm) 2 (Refer to page 5.)</p> 	<p>Hex-head screw for option mounting (5.5mm) 1 (Refer to page 5.)</p> 
---	---	--

1.1.2 Parts

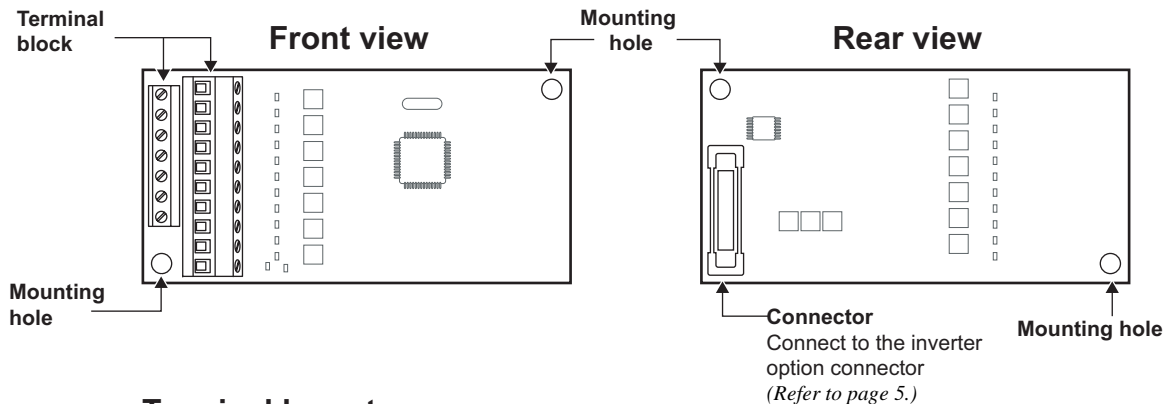

Terminal layout

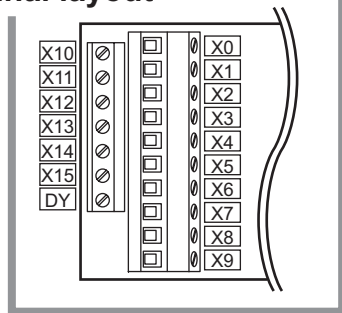

1.1.3 Specifications

- (1) Digital input signal type
 - BCD code 3 digits or 4 digits
 - Binary 12 bits or binary 16 bits
- (2) Selection of digital input signal
 - Select from the operation panel or parameter unit.
- (3) Input current
 - 5mA(24VDC) for each circuit
- (4) Input specifications
 - Contact signal or open collector input
- (5) Adjustment function
 - Bias and gain
 - Analog compensation input
 - (Set using the operation panel)

2 / **INSTALLATION AND WIRING**

2.1 Pre-Installation Instructions

Make sure that the input power of the inverter is off.

CAUTION

 **With input power on, do not install or remove the plug-in option. Otherwise, the inverter and plug-in option may be damaged.**

2.2 Installation Procedure

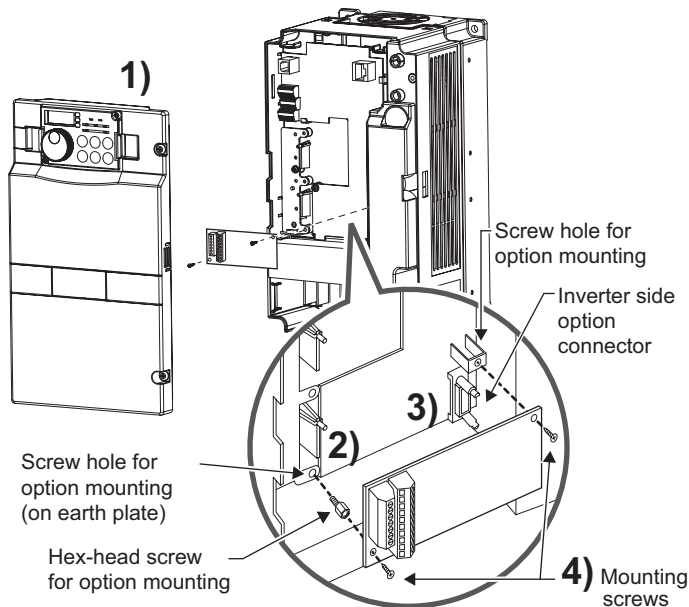

- 1) Remove the inverter front cover.
- 2) Mount the hex-head screw for option mounting into the inverter screw hole (on earth plate). (size 5.5mm, tightening torque 0.56N·m to 0.75N·m)
- 3) Securely fit the connector of the plug-in option to the inverter connector along the guides.
- 4) Securely fix the both right and left sides of the plug-in option to the inverter with the accessory mounting screws. If the screw holes do not line-up, the connector may not have been plugged snugly. Check for loose plugging.

REMARKS

After removing two screws on the right and left places, remove the plug-in option.
(When the plug-in option is mounted in the connector 3 (connector 1 for the FR-F700 series), it is easier to remove the plug-in option after removing a control circuit terminal block.)

CAUTION

- When two or more options are mounted, priority is in order of inverter option connectors 1, 2 and 3, the options having lower priority are inoperative.
- When the inverter cannot recognize that the option is mounted due to improper installation, etc., "E. 1 to E. 3" (option alarm) are displayed for the FR-A700 series. The errors shown differ according to the mounting positions (connectors 1, 2, 3).

Mounting Position	Error Display
Connector 1	E. 1
Connector 2	E. 2
Connector 3	E. 3

- The FR-F700 series has one connection connector for the plug-in option. When the inverter can not recognize that the option unit is mounted due to improper installation, etc., "E. 1" (option alarm) is displayed.
- Take care not to drop a hex-head screw for option mounting or mounting screw during mounting and removal.
- Pull out the option straight to remove. Otherwise, the connector may be damaged by some applied force.

2.3 Wiring

- (1) Strip off the sheath of the cable to wire.
Strip off the sheath about the size below. If the length of the sheath peeled is too long, a short circuit may occur among neighboring wires. If the length is too short, wires might come off.

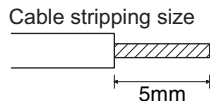

Wire the stripped cable after twisting it to prevent it from becoming loose. In addition, do not solder it. Use a bar type terminal as required.

REMARKS

Information on bar terminals

Introduced products (as of October, 2003): Phoenix Contact Co.,Ltd.

Terminal Screw Size	Bar Terminal Model (with insulation sleeve)	Bar Terminal Model (without insulation sleeve)	Wire Size (mm ²)
M2	AI 0.5-6WH	A 0.5-6	0.3 to 0.5

· Bar terminal crimping tool: CRIMPFOX ZA3 (Phoenix Contact Co., Ltd.)

When using the bar terminal (without insulation sleeve), use care so that the twisted wires do not come out.

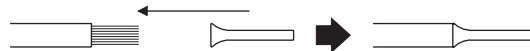

- (2) Loosen the terminal screw and insert the cable into the terminal.

Screw Size	Tightening Torque	Cable Size	Screwdriver
M2	0.22N·m to 0.25N·m	0.3mm ² to 0.75mm ²	Small ⊖ flat-blade screwdriver (Tip thickness: 0.4mm/tip width: 2.5mm)

CAUTION

Undertightening can cause cable disconnection or malfunction. Overtightening can cause a short circuit or malfunction due to damage to the screw or unit.

INSTALLATION AND WIRING

- (3) For wiring of the **FR-A700 series 22K or less** and the **FR-F700 series 30K (FR-F720-01250, FR-F740-00620) or less**, route wires between the control circuit terminal block and front cover. If cables can not be routed between the control circuit terminal block and front cover due to the increased number of cables, remove a hook of the front cover and use a space become available.
For wiring of the **FR-A700 series 30K or more** and the **FR-F700 series 37K (FR-F720-01540, FR-F740-00770) or more**, use the space on the left side of the control circuit terminal block.

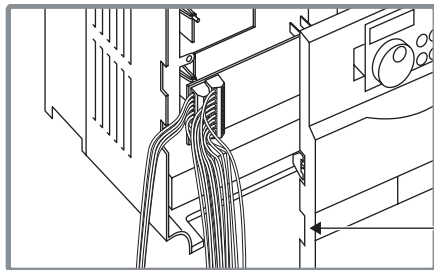

**FR-A700 series 22K or less
and FR-F700 series 30K or less**

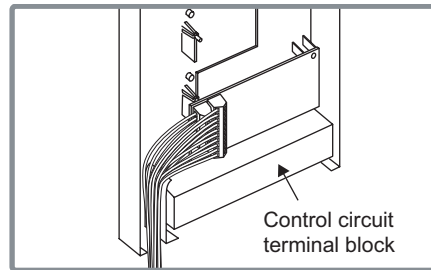
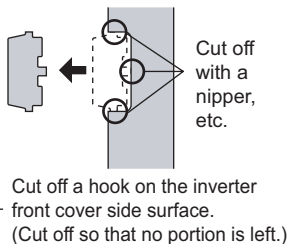

**FR-A700 series 30K or more
and FR-F700 series 37K or more**

REMARKS

When the hook of the inverter front cover is cut off for wiring, the protective structure (JEM1030) changes to open type (IP00 (The structure of the NA version is no longer NEMA 1.)).

CAUTION

- ⚠ When performing wiring using the space between the inverter front cover and control circuit terminal block, take care not to subject the cable to stress.
- ⚠ After wiring, wire offcuts must not be left in the inverter. They may cause a fault, failure or malfunction.

3 CONNECTION DIAGRAM AND TERMINAL

3.1 Connection Diagram

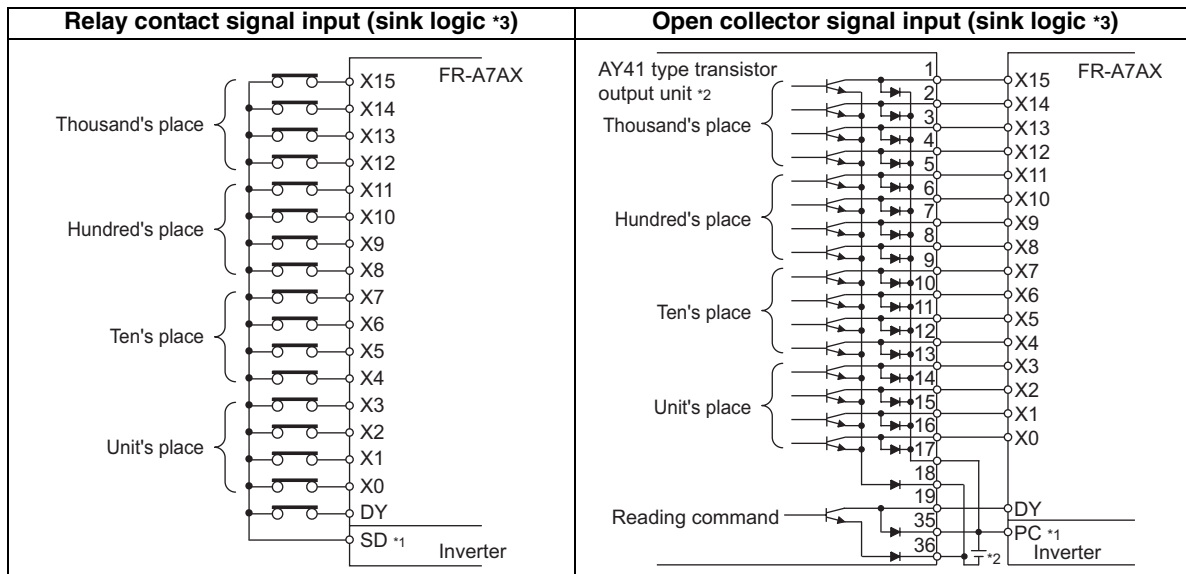

*1 Use terminals SD or PC on the inverter.

*2 AY41 type unit requires 24VDC power.

Example of connection with the output module (AY41 type) of Mitsubishi PLC. Refer to the output module manual for details of the output module.

*3 The control logic is the same as that of the inverter.

When the logic of the inverter is changed, the option logic also changes. For details of changing the control logic, refer to the inverter manual.

REMARKS

1. As the input signals are at low level, use two parallel micro signal contacts or a twin contact for relay contact inputs to prevent a contact fault.

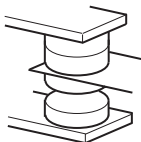

Micro signal contacts

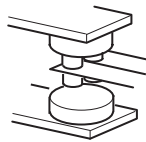

Twin contacts

2. A transistor of the following specifications should be selected for the open collector signal:
Electrical characteristics of the transistor used
 - $I_c \geq 10\text{mA}$
 - Leakage current: $100\mu\text{A}$ maximum
 - $V_{CE} \geq 30\text{V}$
 - If $I_c \geq 10\text{mA}$, $V_{CE(\text{sat})}$ voltage is 3V maximum

3.2 Internal Block Diagram

The following is the internal block diagram of the FR-A7AX.

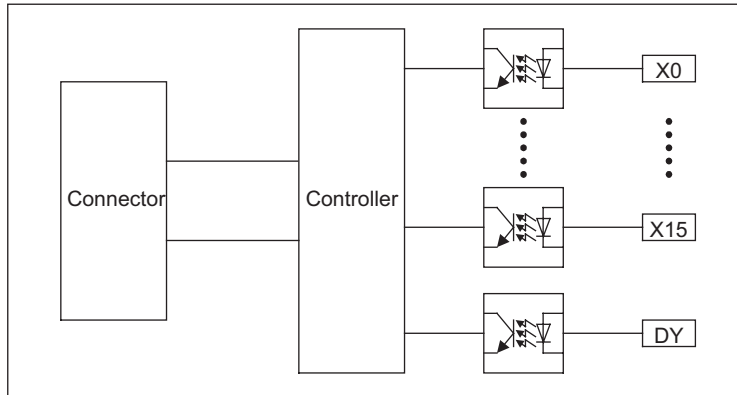

3.3 Terminals

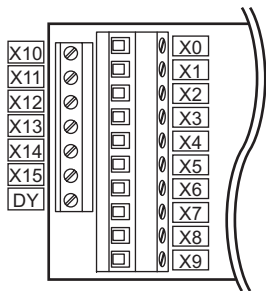

Terminal Location	Terminal Symbol	Description
Plug-in option	X0 to X15	Digital signal input terminal (frequency setting signal terminal) Input the digital signal at the relay contact or open collector terminal. (Refer to page 9.) For the digital signal input, you can choose either the BCD code input or binary input. BCD code input...3 digits (999 maximum) or 4 digits (9999 maximum) Binary inputbinary 12 bits (X0 to X11, FFFH maximum) or binary 16 bits (X0 to X15, FFFFH maximum)
	DY	Data read timing input signal Used when a digital signal read timing signal is necessary. Data is read only during the DY signal is on. By switching the DY signal off, the X0 to X15 data before signal-off is retained. (Refer to page 18.)
Inverter	SD	Common terminal (sink) Common terminal for digital and data read timing signals. Use terminal SD of the inverter.
	PC	External transistor common terminal (sink), common terminal (source) When connecting the transistor output (open collector output) of a programmable controller (PLC), etc., connect the external power common (+) to this terminal to prevent a fault occurring due to leakage current. When you have selected the source logic, this terminal is used as a common terminal. Use terminal PC of the inverter.

3.4 Code Input Example

The following explains examples of terminal status and input value at BCD code input and binary input.

Example: when the input value is 6325

BCD Code Input			
Digit	Terminal name	Terminal input status	Input value
1	X0	ON	5
	X1	OFF	
	X2	ON	
	X3	OFF	
10	X4	OFF	2
	X5	ON	
	X6	OFF	
	X7	OFF	
100	X8	ON	3
	X9	ON	
	X10	OFF	
	X11	OFF	
1000	X12	OFF	6
	X13	ON	
	X14	ON	
	X15	OFF	

Example: when the input value is AB65_H

Binary Input			
Terminal name	Terminal input status	Input value (hexadecimal)	Input value (decimal)
X0	ON	5	43877
X1	OFF		
X2	ON		
X3	OFF		
X4	OFF	6	
X5	ON		
X6	ON		
X7	OFF		
X8	ON	B	
X9	ON		
X10	OFF		
X11	ON		
X12	OFF	A	
X13	ON		
X14	OFF		
X15	ON		

CAUTION

For the BCD code input, the input value of each digit is from 0 to 9. When the value greater than 9 is input, it is made invalid and the last value is retained.

4 PARAMETERS

4.1 Parameter List

When the FR-A7AX is fitted, the following parameters can be set.

The FR-A7AX does not function with the factory setting. When a value other than "9999" is set in *Pr. 304*, digital input is enabled.

Set the following parameters according to applications.

Parameter Number	Name	Setting Range	Initial Value	Setting Increments	Refer to page
300	BCD code input bias	0 to 400Hz	0Hz	0.01Hz	20
301	BCD code input gain	0 to 400Hz, 9999	60Hz (50Hz) *2	0.01Hz	21
302	Binary input bias	0 to 400Hz	0Hz	0.01Hz	20
303	Binary input gain	0 to 400Hz, 9999	60Hz (50Hz) *2	0.01Hz	21
304	Selection of digital input and analog input compensation enable/disable	0 to 4, 10 to 14, 9999 *1	9999	1	16, 23
305	Data read timing signal on-off selection	0, 1, 10	0	1	18
329	Digital input increments selection *3	0, 1, 2, 3	1	1	22
447 *4	Digital torque command bias	0 to 400%	0	1%	23
448 *4	Digital torque command gain	0 to 400%, 9999	150%	1%	23
804 *4	Torque command source selection	0, 1, 3 to 6	0	1	23

- *1 Setting values "4" and "14" are available with the FR-A700 series only.
- *2 The initial value of the EC version is 50Hz.
- *3 For *Pr. 329*, write is disabled during operation even when "2" is set in *Pr. 77*. When changing the parameter setting, stop the operation. Also parameter clear is made invalid.
- *4 These parameters can be set for the FR-A700 series only.

REMARKS

Binary input..... The input data is taken in hexadecimal

BCD code input..... The input data is taken in decimal



4.2 Parameter Setting

4.2.1 Selection of input method (Pr. 304)

Parameter Number	Name	Setting Range	Initial Value	Setting Increments
304	Selection of digital input and analog input compensation enable/disable	0 to 4, 10 to 14, 9999	9999	1

Pr. 304 Setting	Binary Input	BCD Code Input	Availability of Analog Input Compensation *1 (○: enabled, ×: disabled)
0	—	3 digits	×
1	12bit	—	×
2	—	3 digits	○
3	12bit	—	○
4 *2	12bit Torque command value input	—	—
10	—	4 digits	×
11	16bit	—	×
12	—	4 digits	○
13	16bit	—	○
14 *2	16bit Torque command value input	—	—
9999 (initial value)	No function		

- *1 Use terminal 1 for analog input compensation. Refer to the inverter instruction manual (applied) for details of terminal 1.
- *2 These parameters can be set for the FR-A700 series only.
Refer to *page 23* for details of torque command value input.

REMARKS

- Signal X12 to X15 become invalid when 0 to 3 are set in *Pr. 304*.
- Refer to page 13 for BCD code/ binary input example.



4.2.2 Data read timing signal on-off selection (Pr. 305)

Parameter Number	Name	Setting Range	Initial Value	Setting Increments
305	Data read timing signal on-off selection	0, 1, 10	0	1

Pr. 305 Setting	Filter	Description
0 (initial value)	Without	The set frequency data entered from the digital signal input terminals (X0 to X15) is always imported independently of whether the DY signal is on or off.
1	Without	The set frequency data entered from the digital signal input terminals (X0 to X15) is imported only when the DY signal is on. The set frequency data is not imported when the DY signal is off. Therefore, even if the input status of the X0-X15 signal changes, the set frequency data before off of the DY signal is valid.
10	With	The set frequency data entered from the digital signal input terminals (X0 to X15) is always imported independently of whether the DY signal is on or off. The time lag when digital signals change can be compensated with a filter.

● When "0 or 10" is set in Pr. 305

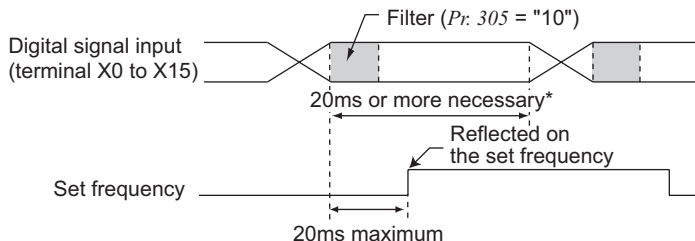

* Hold the digital signal input (X0 to X15) status for 20ms or more.

● How to use the DY signal (when "1" is set in Pr. 305)

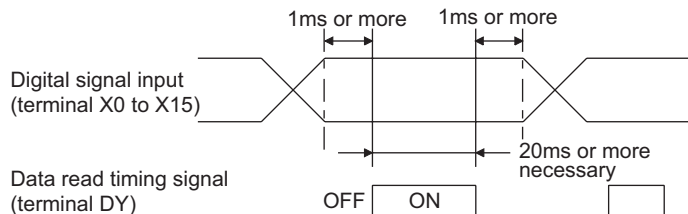

REMARKS

When Pr. 305 = "1", each terminal from X0 to X15 is all recognized as off when the inverter is turned on in terminal DY off status.

For example, when bias is set to 20Hz, turning the power supply on in the DY signal off status and then turning on the start signal will make the frequency command valid, starting the inverter to operate at 20Hz.

● SERIAL number check

The setting of "10" for Pr. 305 can be used for the FR-A700 series and FR-F700 series 55K (01160 (EC Version)) or less produced in June 2004 or later. Check the SERIAL number indicated on the inverter rating plate or package.

[SERIAL]

<u>0</u>	<u>4</u>	<u>6</u>	<u>000000</u>
Symbol	Year	Month	Control number



4.2.3 Bias and gain adjustment (Pr. 300, Pr. 301, Pr. 302, Pr. 303)

Parameter Number	Name	Setting Range	Initial Value	Setting Increments
300	BCD code input bias	0 to 400Hz	0Hz	0.01Hz
301	BCD code input gain	0 to 400Hz, 9999	60Hz (50Hz) *	0.01Hz
302	Binary input bias	0 to 400Hz	0Hz	0.01Hz
303	Binary input gain	0 to 400Hz, 9999	60Hz (50Hz) *	0.01Hz

* The initial value of the EC version is 50Hz.

(1) Bias adjustment

Bias adjustments can be made for the digital input signal.

Set the set frequency at the digital input of 0.

- BCD code input..... Set using *Pr. 300*.
- Binary input..... Set using *Pr. 302*.

(2) Gain adjustment

The gain may be set in either of the following two ways:

How to set the output frequency when the input signal is 999 or 9999 (BCD code), and FFFH or FFFFH (binary).

- BCD code input .. Set using *Pr. 301*.
- Binary input Set using *Pr. 303*.

The output frequency is factory-set to 60Hz (EC version : 50Hz).

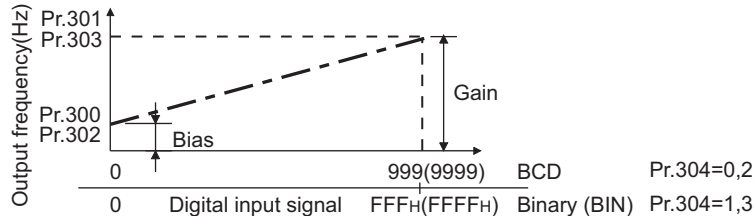

CAUTION

The maximum output frequency for operation with the digital input signal is the "gain" value set in *Pr. 301* and *Pr. 303*.

To set the maximum output frequency at 60Hz (EC version : 50Hz) or more, change "gain" with the operation panel.

How to set the BCD code or binary value as the output frequency setting

When "9999" is set in *Pr. 301* (BCD code) or *Pr. 303* (binary), the digital input value is set as the output frequency.

(For example, to set the output frequency to 120Hz when the BCD code input is "120")

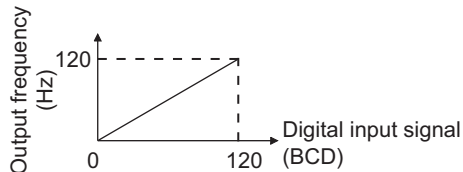

REMARKS

When this setting method is used, "bias" setting (*Pr. 300* or *Pr. 302*) cannot be made.



4.2.4 Digital input increments selection (Pr. 329)

Parameter Number	Name	Setting Range	Initial Value	Setting Increments
329	Digital input increments selection *1	0, 1, 2, 3	1	1

When "9999" is set in *Pr. 301 BCD code input gain* or *Pr. 303 Binary input gain*, the increments when the digital signal is set as output frequency can be set.

Frequency = digital input signal value × *Pr. 329* input increments

<i>Pr. 329</i> Setting	Input Value Increments	Available Frequencies *1			
		12bit		16bit	
		BCD code	Binary	BCD code	Binary
0	10	0 to 9990Hz	0 to 40950Hz	0 to 99990Hz	0 to 655350Hz
1 (factory setting)	1	0 to 999Hz	0 to 4095Hz	0 to 9999Hz	0 to 65535Hz
2	0.1	0 to 99.9Hz	0 to 409.5Hz	0 to 999.9Hz	0 to 6553.5Hz
3	0.01	0 to 9.99Hz	0 to 40.95Hz	0 to 99.99Hz	0 to 655.35Hz

*1 These are not the inverter maximum output frequencies.

REMARKS

When the values other than "9999" are set in *Pr. 301* or *Pr. 303*, *Pr. 329* is made invalid.

<Example>

<i>Pr. 329</i> = 0	BCD code = 111	→	1110Hz
	Binary = 100H (256 in decimal)	→	2560Hz
<i>Pr. 329</i> = 1	BCD code = 111	→	111Hz
	Binary = 100H (256 in decimal)	→	256Hz
<i>Pr. 329</i> = 2	BCD code = 111	→	11.1Hz
	Binary = 100H (256 in decimal)	→	25.6Hz
<i>Pr. 329</i> = 3	BCD code = 111	→	1.11Hz
	Binary = 100H (256 in decimal)	→	2.56Hz

4.2.5 16 bit digital torque command (FR-A700 series only)

Parameter	Name	Setting Range	Initial Value	Increments
304	Selection of digital input and analog input compensation enable/disable	0 to 4, 10 to 14, 9999	9999	1
447	Digital torque command bias	0 to 400%	0	1%
448	Digital torque command gain	0 to 400%, 9999	150%	1%
804	Torque command source selection	0, 1, 3 to 6	0	1

Digital torque command can be given under torque control using the FR-A7AX .

A digital command using the FR-A7AX can be given when "4 (12 bit)" or "14 (16 bit)" is set in *Pr.304* and "4" is set in *Pr.804 Torque command source selection*.

Pr.804 parameter setting	Description	Remarks
0	Torque command by terminal 1 analog input	Refer to the inverter manual for details.
1	Torque command by parameter setting Setting value of <i>Pr.805</i> or <i>Pr.806</i> (-400% to 400%)	
3	Torque command by CC-Link communication (FR-A7NC)	Refer to the instruction manual of the FR-A7NC for details.
4	12 bit digital input (FR-A7AX)	When "4" is set in <i>Pr. 304</i>
	16 bit digital input (FR-A7AX)	When "14" is set in <i>Pr. 304</i>
5	Refer to the inverter manual for details.	Refer to the instruction manual of the FR-A7NC for details.
6	Torque command by CC-Link communication (FR-A7NC)	

PARAMETERS



The input signal uses the last 15 (11) bits as torque command and the most significant bit as sign.

When 16 bit is selected

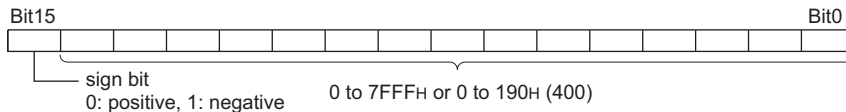

REMARKS

The digital torque command is input only by binary input.

● **Input method of torque command**

Torque command may be input in either of the following two ways:

(1) Method to define the torque command value for the input command by setting the torque command value when the input signal is 0 and plus side torque command value when the input signal is 7FFFH (7FFH) as shown in the graph

Set the torque command value when the input signal is "0" in *Pr.447* and the torque command value when the input signal is "7FFFH (7FFH)" in *Pr.448* .

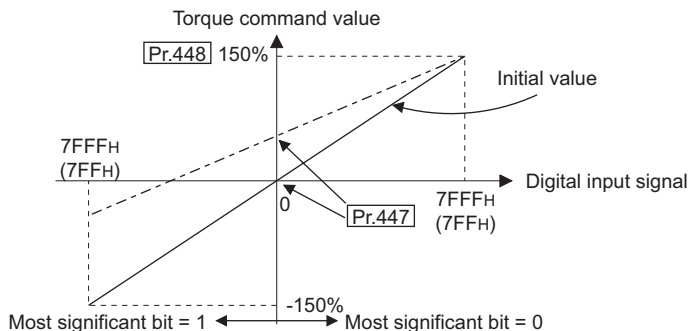



(2) Method to directly input the torque command value as numeral value in digital

When "9999" is set in *Pr.448*, the input signal is considered as a torque command value.

Even if a value higher than 190H (400) is input, the torque command value is clamped at 400%.

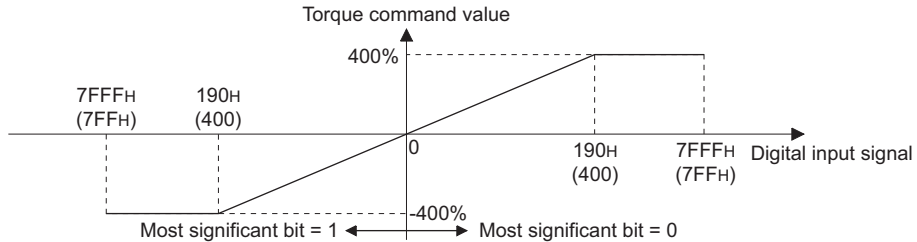

4.3 Instructions

- (1) Acceleration/deceleration time
When the frequency is set with the digital input signal, the acceleration/deceleration time is the period of time required to reach the *Acceleration/deceleration reference frequency* set in *Pr. 20*. This is the same as when using the analog signal input.
- (2) There are the following restrictions on the digital input signal:
When the signal is used to enter a BCD code, 0AH to 0FH entries are ignored during operation and the previous inputs are used to continue operation.
If binary input is changed to BCD code input with 0AH to 0FH input, the set frequency becomes 0Hz.
- (3) If 0 to 5V (0 to 10V) is input at the inverter terminal 1 from the external volume with the FR-A7AX fitted, the inverter operates at the frequency obtained by adding the FR-A7AX BCD code input and the compensation input from terminal 1 only when "2, 3, 12 or 13" is set in *Pr. 304*.
When switching the inputs e.g. between volume input to perform manual operation and BCD code input to perform automatic operation, set the BCD code input to "0" under manual operation.
- (4) The priorities of the frequency setting are as follows.
JOG>Multi-speed operation (RH, RM, RL) >PID (X14) >AU (terminal 4) >Digital command by the FR-A7AX > terminal 2"
(When digital input is valid, terminal 2 is invalid.)

REVISIONS

*The manual number is given on the bottom left of the back cover.

Print Date	*Manual Number	Revision
May, 2004	IB(NA)-0600164ENG-A	First edition
Sep.,2005	IB(NA)-0600164ENG-B	<u>Additions</u> Compatible with the FR-A700 series

INVERTER

