



# INVERTER

Plug-in option

# FR-A7NL

# INSTRUCTION MANUAL

---

*LONWORKS<sup>®</sup> communication function*

---

PRE-OPERATION INSTRUCTIONS

1

INSTALLATION

2

WIRING

3

INVERTER SETTING

4

FUNCTION OVERVIEW

5

NETWORK VARIABLES

6

FREQUENCY AND SPEED  
CONVERSION SPECIFICATIONS

7

TROUBLESHOOTING

8

Thank you for choosing this Mitsubishi Inverter plug-in option. This instruction manual gives handling information and precautions for use of this equipment. Incorrect handling might cause an unexpected fault. Before using the equipment, please read this manual carefully to use the equipment to its optimum. Please forward this manual to the end user.

## This section is specifically about safety matters

Do not attempt to install, operate, maintain or inspect this product until you have read through this instruction manual and appended documents carefully and can use the equipment correctly. Do not use this product until you have a full knowledge of the equipment, safety information and instructions.

In this instruction manual, the safety instruction levels are classified into "WARNING" and "CAUTION".

### **WARNING**

Assumes that incorrect handling may cause hazardous conditions, resulting in death or severe injury.

### **CAUTION**

Assumes that incorrect handling may cause hazardous conditions, resulting in medium or slight injury, or may cause physical damage only.

Note that even the  **CAUTION** level may lead to a serious consequence according to conditions. Please follow the instructions of both levels because they are important to personnel safety.

## SAFETY INSTRUCTIONS

### 1. Electric Shock Prevention

#### **WARNING**

- While power is on or when the inverter is running, do not open the front cover. You may get an electric shock.
- Do not run the inverter with the front cover or wiring cover removed. Otherwise, you may access the exposed high-voltage terminals and charging part and get an electric shock.
- If power is off, do not remove the front cover except for wiring or periodic inspection. You may access the charged inverter circuits and get an electric shock.
- Before starting wiring or inspection, check to make sure that the indication of the inverter operation panel is off, wait for at least 10 minutes after the power supply has been switched off, and check that there are no residual voltage using a tester or the like. The capacitor is charged with high voltage for some time after power off and it is dangerous.
- Any person who is involved in the wiring or inspection of this equipment should be fully competent to do the work.
- Always install the plug-in option before wiring. Otherwise, you may get an electric shock or be injured.
- Do not touch the plug-in option with wet hands. Otherwise you may get an electric shock.
- Do not subject the cables to scratches, excessive stress, heavy loads or pinching. Otherwise you may get an electric shock.

## 2. Injury Prevention

### CAUTION

- Apply only the voltage specified in the instruction manual to each terminal. Otherwise, burst, damage, etc. may occur.
- Ensure that the cables are connected to the correct terminals. Otherwise, burst, damage, etc. may occur.
- Always make sure that polarity is correct to prevent damage, etc. Otherwise, burst, damage may occur.
- While power is on or for some time after power-off, do not touch the inverter as it is hot and you may get burnt.

## 3. Additional Instructions

Also note the following points to prevent an accidental failure, injury, electric shock, etc.

### 1) Transportation and mounting

### CAUTION

- Do not install or operate the plug-in option if it is damaged or has parts missing.
- Do not stand or rest heavy objects on the product.
- Check that the mounting orientation is correct.
- Prevent other conductive bodies such as screws and metal fragments or other flammable substance such as oil from entering the inverter.

### 2) Trial run

### CAUTION

- Before starting operation, confirm and adjust the parameters. A failure to do so may cause some machines to make unexpected motions.

## 3) Usage

### WARNING

- Do not modify the equipment.
- Do not perform parts removal which is not instructed in this manual. Doing so may lead to fault or damage of the inverter.

### CAUTION

- When parameter clear or all parameter clear is performed, reset the required parameters before starting operations. Each parameter returns to the initial value.
- For prevention of damage due to static electricity, touch nearby metal before touching this product to eliminate static electricity from your body.

### 4) Maintenance, inspection and parts replacement

### CAUTION

- Do not test the equipment with a megger (measure insulation resistance).

### 5) Disposal

### CAUTION

- Treat as industrial waste.

### 6) General instruction

All illustrations given in this manual may have been drawn with covers or safety guards removed to provide in-depth description. Before starting operation of the product, always return the covers and guards into original positions as specified and operate the equipment in accordance with the manual.

# — CONTENTS —

<b>1</b>	<b>PRE-OPERATION INSTRUCTIONS</b>	<b>1</b>
1.1	Inverter Type .....	1
1.2	Unpacking and Product Confirmation .....	2
1.2.1	Packing confirmation .....	2
1.2.2	Parts .....	3
1.2.3	SERIAL number check .....	4
1.3	Operation Status Indication LED .....	5
1.4	Specifications .....	6
1.4.1	Inverter option specifications .....	6
1.4.2	Communication specification .....	6
<b>2</b>	<b>INSTALLATION</b>	<b>7</b>
2.1	Pre-Installation Instructions .....	7
2.2	Installation of the Communication Option LED Display Cover .....	7
2.3	Installation Procedure .....	8
<b>3</b>	<b>WIRING</b>	<b>10</b>
3.1	System Configuration Example .....	10
3.2	Wiring .....	11
<b>4</b>	<b>INVERTER SETTING</b>	<b>15</b>
4.1	Parameter List .....	15
4.2	Operation Mode Setting .....	16
4.2.1	Operation mode indication .....	16
4.2.2	Operation mode switching and communication startup mode (Pr. 79, Pr. 340) .....	17

<b>4.3</b>	<b>Operation and Speed Command Source (Pr. 338, Pr. 339, Pr. 550)</b> .....	<b>20</b>
4.3.1	Communication EEPROM write selection (Pr. 342) .....	24
<b>4.4</b>	<b>Operation at Communication Error Occurrence</b> .....	<b>25</b>
4.4.1	Operation selection at communication error occurrence (Pr. 500 to Pr. 502) .....	25
4.4.2	Alarm and measures .....	29
<b>4.5</b>	<b>Inverter Reset</b> .....	<b>31</b>
<b>5</b>	<b>FUNCTION OVERVIEW</b> .....	<b>33</b>
<b>5.1</b>	<b>XIF File</b> .....	<b>33</b>
<b>5.2</b>	<b>Output from the Inverter to the Network</b> .....	<b>34</b>
<b>5.3</b>	<b>Input from the Network to the Inverter</b> .....	<b>35</b>
<b>6</b>	<b>NETWORK VARIABLES</b> .....	<b>37</b>
<b>6.1</b>	<b>Object Map</b> .....	<b>37</b>
<b>6.2</b>	<b>Network Variable List</b> .....	<b>38</b>
<b>6.3</b>	<b>LONWORKS Object</b> .....	<b>42</b>
6.3.1	Setting range of object ID .....	42
6.3.2	Object request (network input SNVT_obj_request nviRequest) .....	43
6.3.3	Object status (network output SNVT_obj_status nvoStatus) .....	44
<b>6.4</b>	<b>Variable Speed Motor Drive Object</b> .....	<b>45</b>
6.4.1	Start/stop and simple speed setting (network input SNVT_switch nviDrvSpeedStpt) .....	45
6.4.2	Speed adjustment (0.005% increments) (network input SNVT_lev_percent nviDrvSpeedScale) .....	46
6.4.3	Speed monitor (0.005% increments) (network output SNVT_lev_percent nvoDrvSpeed) .....	47
<b>6.5</b>	<b>Inverter Basic Functions</b> .....	<b>48</b>
6.5.1	Inverter input signal (network input SNVT_state nvilnvInputSig) .....	48
6.5.2	Inverter output signal (network output SNVT_state nvolnvOutputSig) .....	49
6.5.3	Set frequency write destination selection (network input SNVT_switch nvilnvSetFreqSw) .....	50
6.5.4	Set frequency (0.1Hz increments) (network input SNVT_freq_hz nvilnvSetFreq) .....	51
6.5.5	Set frequency (0.005% increments) (network input SNVT_lev_percent nvilnvSetFreqP) .....	51

6.5.6	Output frequency monitor (0.1Hz increments) (network output SNVT_freq_hz nvoInvOutFreq)	52
6.5.7	Output frequency monitor (0.005% increments) (network output SNVT_lev_percent nvoInvOutFreqP)	53
6.5.8	Output current monitor (0.1A increments) (network output SNVT_amp nvoDrvCurrt)	54
6.5.9	Output voltage monitor (0.1V increments) (network output SNVT_volt nvoDrvVolt)	54
6.5.10	Actual operation time monitor (1h increments) (network output SNVT_time_hour nvoDrvRunHours)	54
6.5.11	Cumulative power monitor (1kWh increments) (network output SNVT_elec_kwh nvoDrvRunPower)	55
6.5.12	Cumulative power monitor 2 (0.1kWh increments) (network output SNVT_elec_kwh_I nvoDrvRunPower_I)	56
6.5.13	Alarm reset (network input SNVT_switch nvilnvAlarmReset)	56
6.5.14	Alarm occurrence definition (network output SNVT_str_asc nvoInvAlarmStr)	57
6.5.15	Product information (maker name, type) (network output SNVT_str_asc nvoInvTypeInfo)	60
6.5.16	Emergency stop command (network input SNVT_hvac_emerg nviEmergOverride)	61
6.5.17	Emergency stop status (network output SNVT_hvac_emerg nvoEmergStatus)	62
6.5.18	Alarm status (network output SNVT_switch nvoDrvAlarm)	63
<b>6.6</b>	<b>Inverter PID Control Functions</b>	<b>64</b>
6.6.1	PID set point (network input SNVT_lev_percent nvilnvPIDTarget)	65
6.6.2	PID measured value (network input SNVT_lev_percent nvilnvPIDValue)	66
6.6.3	PID deviation (network input SNVT_lev_percent nvilnvPIDDev)	67
<b>6.7</b>	<b>Inverter Extended Functions</b>	<b>68</b>
6.7.1	Monitor code (network input SNVT_count nvilnvMonCode)	68
6.7.2	Monitor data (network output SNVT_count nvoInvMonData)	72
6.7.3	Set frequency (0.01Hz increments) (network input SNVT_count nvilnvSetFreq2)	73
6.7.4	Output frequency monitor (0.01Hz increments) (network output SNVT_count nvoInvOutFreq2)	73
6.7.5	Command request (network input SNVT_str_asc nvilnvCmdReq)	74
6.7.6	Command reply (network output SNVT_str_asc nvoInvCmdReply)	79
<b>6.8</b>	<b>Configuration Properties</b>	<b>80</b>
6.8.1	Initial communication delay time (network input config SNVT_time_sec nciPwUpOutTm)	80
6.8.2	Forward/reverse rotation prevention (network input config SNVT_count ncilnvFwdRevLock)	81
6.8.3	% set reference frequency (network input config SNVT_freq_hz ncilnvSetFreqBas)	82
6.8.4	Maximum frequency (0.1Hz increments) (network input config SNVT_freq_hz ncilnvMaxFreq)	83
6.8.5	Minimum frequency (0.1Hz increments) (network input config SNVT_freq_hz ncilnvMinFreq)	83
6.8.6	Heartbeat send time interval (network input config SNVT_time_sec nciSndHrtBt)	84

6.8.7	Minimum heartbeat send time (network input config SNVT_time_sec nciMinOutTm)	84
6.8.8	Acceleration time (network input config SNVT_time_sec nciRampUpTm)	87
6.8.9	Deceleration time (network input config SNVT_time_sec nciRampDownTm)	88
6.8.10	PID action selection (network input config SNVT_count nciInvPIDSwitch)	89
6.8.11	PID proportional band (network input config SNVT_count nciInvPIDPro)	91
6.8.12	PID integral time (network input config SNVT_time_sec nciInvPIDIntTm)	91
6.8.13	PID differential time (network input config SNVT_time_sec nciInvPIDDiffTm)	92
6.8.14	PID manipulated variable bias (0.1Hz increments) (network input config SNVT_freq_hz nciInvPIDOpeBias)	92
6.8.15	PID manipulated variable gain (0.1Hz increments) (network input config SNVT_freq_hz nciInvPIDOpeGain)	93
6.8.16	Heartbeat receive time interval (network input config SNVT_time_sec nciRcvHrtBt)	94
6.8.17	Maximum speed (0.005% increments) (network input config SNVT_lev_percent nciMaxSpeed)	96
6.8.18	Minimum speed (0.005% increments) (network input config SNVT_lev_percent nciMinSpeed)	96
6.8.19	Reference speed setting (network input config SNVT_rpm nciNmlSpeed)	97
6.8.20	Reference frequency setting (network input config SNVT_freq_hz nciNmlFreq)	98
6.8.21	Speed adjustment default value (network input config SNVT_lev_percent nciDrvSpeedScale)	98
6.8.22	Event driven detection width (network input config SNVT_lev_percent nciInvEvtDuty)	99

---

## **7 FREQUENCY AND SPEED CONVERSION SPECIFICATIONS** **101**

---

## **8 TROUBLESHOOTING** **102**

---

### **APPENDIX** **103**

---

**Setup Example** ..... **103**

**Example of Inverter Parameter Clear** ..... **104**

# 1 PRE-OPERATION INSTRUCTIONS

## 1.1 Inverter Type

The inverter type, 55K and 75K stated in this Instruction Manual differs according to each -NA, -EC, -CH versions. Refer to the following correspondence table for each inverter type. (*Refer to the instruction manual of each inverter for the inverter type.*)

For example, "for the 75K or more" indicates "for the FR-A740-01440-NA or more" in the case of FR-A740 series of NA version.

	NA	EC	CH
FR-F720-55K	FR-F720-02330-NA	—	—
FR-F720-75K	FR-F720-03160-NA	—	—
FR-F740-55K	FR-F740-01160-NA	FR-F740-01160-EC	FR-F740-55K-CH(T)
FR-F740-75K	FR-F740-01800-NA	FR-F740-01800-EC	FR-F740-S75K-CH(T)
FR-A720-55K	FR-A720-02150-NA	—	—
FR-A720-75K	FR-A720-02880-NA	—	—
FR-A740-55K	FR-A740-01100-NA	FR-A740-01800-EC	FR-A740-55K-CHT
FR-A740-75K	FR-A740-01440-NA	FR-A740-02160-EC	FR-A740-75K-CHT





## 1.2 Unpacking and Product Confirmation

Take the plug-in option out of the package, check the unit name, and confirm that the product is as you ordered and intact.

This product is a plug-in option dedicated for the FR-A700/F700/FP700 series.

### 1.2.1 Packing confirmation

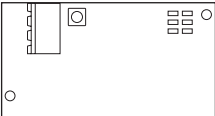
Check the enclosed items.

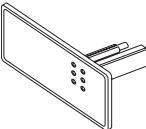
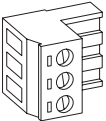
<p>Plug-in option ..... 1</p> 	<p>Mounting screw (M3 × 6mm) ..... 2 (Refer to page 8.)</p> 	<p>Hex-head screw for option mounting (5.5mm) ..... 1 (Refer to page 8.)</p> 
<p>Communication option LED display cover ..... 1 (Refer to page 7.)</p> 	<p>Terminal block ..... 1 (Refer to page 12.)</p> 	<p>· Neuron<sup>®</sup> ID bar code sticker..... 1 (Since one bar code sticker is for maker duplicate, three stickers are provided.)</p> <p>Echelon<sup>®</sup>, LONWORKS<sup>®</sup>, LonMaker<sup>®</sup>, LONMARK<sup>®</sup> and Neuron<sup>®</sup> are registered trademarks of Echelon Corporation in the U.S.A. and other countries. Company and product names herein are the trademarks and registered trademarks of their respective owners.</p>

## 1.2.2 Parts

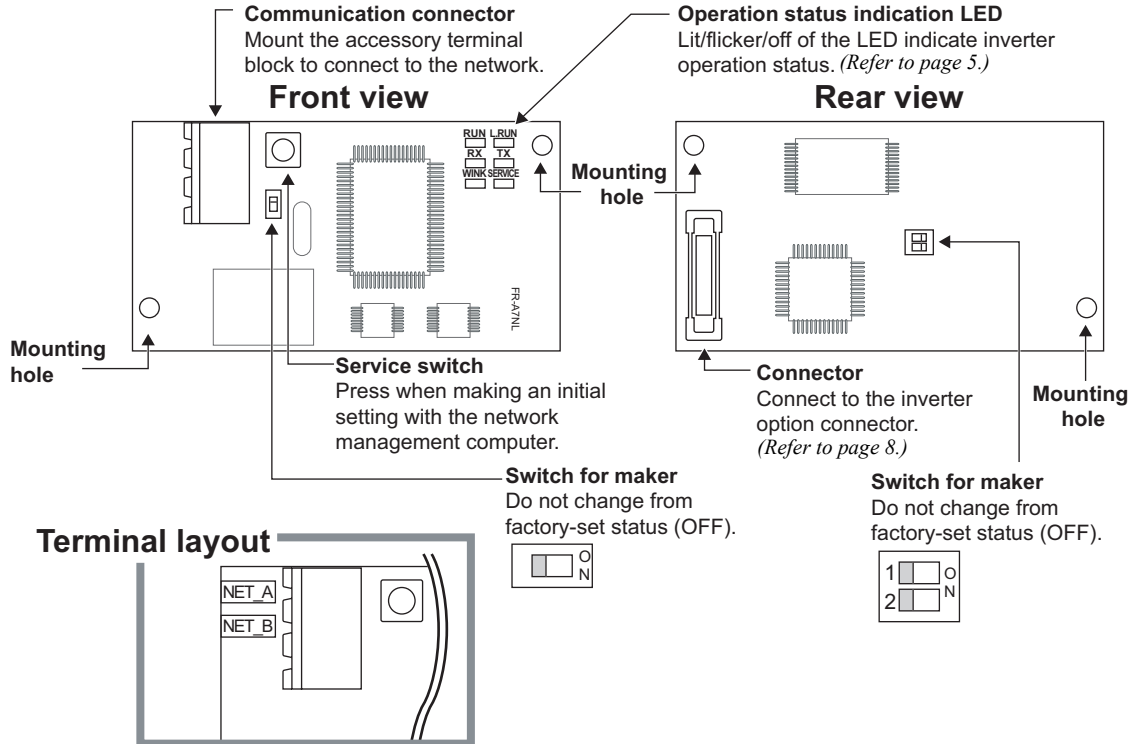

**1**

### **1.2.3 SERIAL number check**

Cumulative power monitor in 0.1kWh increments (nvoDrvRunPower\_l) (Refer to page 56), Selection of number of motor poles of the reference speed setting (nciNmISpeed) (Refer to page 97) is available for the FR-A700/FP700 series and F700 series inverter assembled in and after the date below. Check the SERIAL number indicated on the rating plate or package.

· 55K or less...in and after September 2004, 75K or more...in and after August 2004

#### **● SERIAL number check**

Refer to the inverter manual for the position of the rating plate.

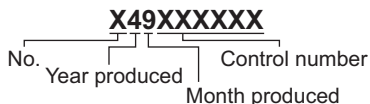

The SERIAL is made up of 1 version symbol, 2 numeric characters or 1 alphabet letter and 2 numeric characters indicating year and month, and 6 numeric characters indicating control number. Month is indicated as 1 to 9, X (October), Y (November), and Z (December).

### 1.3 Operation Status Indication LED

Operation status indication LED indicates the operating status of the option unit according to the indication status.

Check the position of LED on *page 3*.

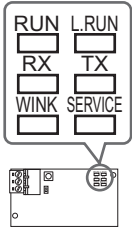
	Name	Function	LED Status	Status
	RUN	Display the unit operation status.	ON	Normal operation
			OFF	Alarm (watchdog timer expiration etc.) detection
	L.RUN	Display the handshaking status with the inverter.	ON	Normal operation
			OFF	Alarm detection
	RX	Display the receiving status of packet from the network.	ON (for about 50ms)	Receiving
			OFF	Stop receiving
	TX *1	Display the transmission status of packet to the network.	ON (for about 50ms)	Transmitting
			OFF	Stop transmission
	WINK	Display the receiving status of WINK message from the network.	Flicker three times	Receiving WINK message
			OFF	Stop
	SERVICE	Display the status of node and service switch.	ON	Service switch pressed status
			Flicker	Unconfigured status
			OFF	Configured status

\*1 TX LED turns on when the inverter autonomously sends data due to heartbeat and event driven function even when the communication cable is not wired.

## 1.4 Specifications

### 1.4.1 Inverter option specifications

<b>Type</b>		Inverter plug-in option type (can be mounted/dismounted to/from the inverter front face)
<b>Number of nodes occupied</b>		One inverter occupies one node.
<b>Connection cable</b>	<b>Free topology</b>	Twisted pair cable equivalent to EBT0.65mm × 1p (ICT 0.65mm × 1p of Fuji Cable (Ltd. ))
	<b>Bus topology</b>	Twisted pair cable equivalent to EBT1.3mm × 1p (ICT 1.3mm × 1p of Fuji Cable (Ltd. ))

### 1.4.2 Communication specification

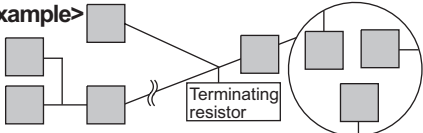
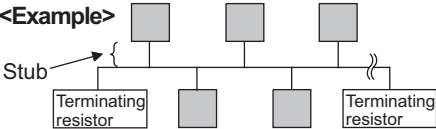
<b>Number of units connected</b>		64 units maximum including the inverter in the same segment.	
<b>Communication speed</b>		78kbps	
<b>Maximum cable length</b>		<p>Free topology (connect a terminating resistor at any one point) Maximum: 500m</p> <p><b>&lt;Example&gt;</b> </p>	<p>Bus topology (connect a terminating resistor at both ends) Maximum: 2700m (The total length of each node stub should be 3m maximum.)</p> <p><b>&lt;Example&gt;</b> </p>
<b>Event reception and transmission</b>	<b>Event reception</b>	Number of events receivable at a time : 20 Reception time per event : 100ms maximum (when not conflicting with event transmission)	
	<b>Event transmission</b>	Transmission time per event · Without bind : 200ms · With bind : [retry interval time] × [number of retries]	

## 2 INSTALLATION

### 2.1 Pre-Installation Instructions

Make sure that the input power of the inverter is off.

#### ⚠ CAUTION

⚠ With input power on, do not install or remove the plug-in option. Otherwise, the inverter and plug-in option may be damaged.

### 2.2 Installation of the Communication Option LED Display Cover

Mount the cover for displaying the operation status indication LED for the communication option on the inverter front cover.

- 1) Cut off hooks on the rear of the inverter front cover with nipper, etc. and open a window for fitting the LED display cover.

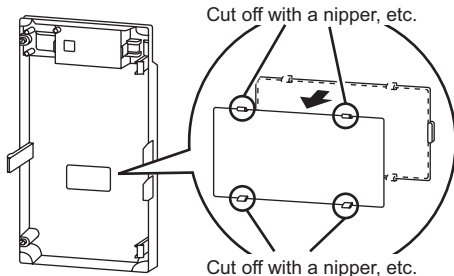

- 2) Fit the communication option LED display cover to the front of the inverter front cover and push it into until fixed with hooks.

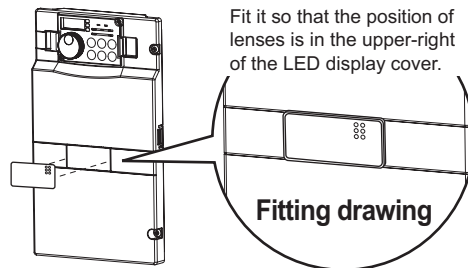

#### ⚠ CAUTION

⚠ Take care not to hurt your hand and such with portions left by cutting hooks of the rear of the front cover.



## 2.3 Installation Procedure

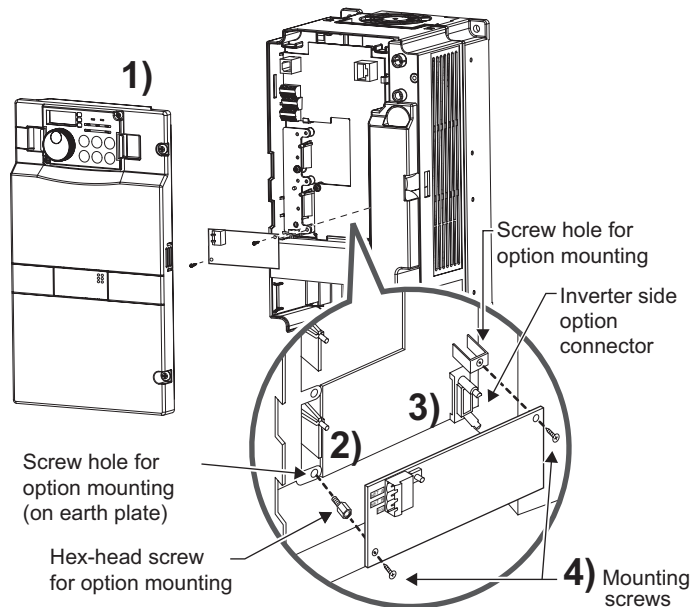

### REMARKS

After removing two screws on the right and left places, remove the plug-in option.  
 (The plug-in option is easily removed if the control circuit terminal block is removed before.)

**CAUTION**

- When using this option unit with the FR-A700 series inverter, mount it in the "option connector 3 (lowermost connector)" of the inverter.

If it is fitted in option connector 1 or 2, "E. 1" or "E. 2" (option alarm) is displayed and the inverter will not function. In addition, when the inverter can not recognize that the option is mounted due to improper installation, etc.,

"E. 3" (option alarm) is displayed even if the option is fitted in the option connector 3.

- The FR-F700/FP700 series has one connection connector for the plug-in option. When the inverter can not recognize that the option unit is mounted due to improper installation, etc., "E. 1" (option alarm) is displayed.
- Take care not to drop a hex-head screw for option mounting or mounting screw during mounting and removal.
- Pull out the option straight to remove. Otherwise, the connector may be damaged by some applied force.

Mounting Position	Error Display
Connector 1	E. 1
Connector 2	E. 2
Connector 3	E. 3



# 3 WIRING

## 3.1 System Configuration Example

- (1) Mount the communication option (FR-A7NL) on the inverter. (Refer to page 8.)
- (2) Connect the LONWORKS node, network management computer, and terminating resistor with the cable for LONWORKS communication.

Select a terminating resistor so that resistance values of R of the RC network are the same as shown below.

- Free topology (Refer to page 6) ..... R =  $52.3\Omega \pm 1\%$  1/8W
  - Bus topology (Refer to page 6) ..... R =  $105\Omega \pm 1\%$  1/8W
- (3) Install the network management tool on the network management computer to assign the network address and bind (association function) the network variable, etc. to the LONWORKS node.

### (Example) Bus topology (without stub)

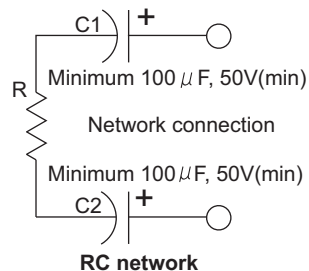
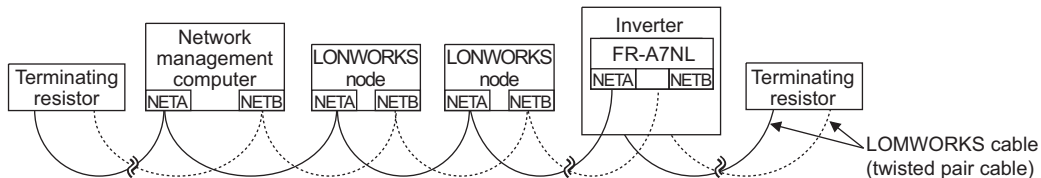

### REMARKS

- The network management tool is not included with this product. Please purchase it separately. For the network management tool, LonMaker by Echelon Co. is recommended.
- When the option unit has been replaced because of a fault or others, perform "Commission" or "Replace" from the network management tool after switching on the inverter. After performing "Commission" or "Replace", reset the inverter (switch power off once, then on again or turn the RES signal on).
- Use the network management computer in the earthed status. Use the isolated power supply if the computer can not be earthed.

## 3.2 Wiring

- (1) Strip off the sheath of the cable for LONWORKS communication. If the length of the sheath peeled is too long, a short circuit may occur among neighboring wires. If the length is too short, wires might come off.

Cable stripping size

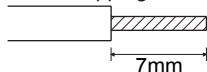

**Wire the stripped cable after twisting it to prevent it from becoming loose.  
In addition, do not solder it.  
Use a bar type terminal as required.**

- (2) Loosen the terminal screw and insert the cable into the terminal.  
Tighten the fastening screws to the recommended tightening torques. Leave the other end of the cable unconnected.

Screw Size	Tightening Torque	Cable Size	Screwdriver
M3	0.5N·m to 0.6N·m	0.3mm <sup>2</sup> to 0.75mm <sup>2</sup>	Small ⊖ flat-blade screwdriver (Tip thickness: 0.4mm /tip width: 2.5mm)

### CAUTION

**Undertightening can cause cable disconnection or malfunction. Overtightening can cause a short circuit or malfunction due to damage to the screw or unit.**



## <When using one twisted pair cable>

Twisted pair cable  
To be connected  
to other node

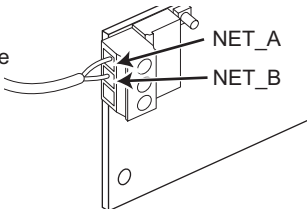

## <When using two twisted pair cables>

Twisted pair cable  
To be connected to  
other node

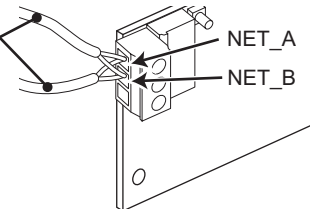

### REMARKS

Change the number of twisted pair cables to insert in NET\_A and NET\_B according to the system used.

(3) Connect the terminal block to the connector for communication of the communication option.

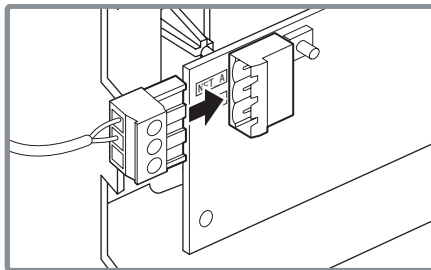

- (4) For wiring of **the FR-A700 series 22K\* or less, the FR-F700 series 30K\* or less and the FR-FP700 series**, route wires between the control circuit terminal block and front cover. If cables can not be routed between the control circuit terminal block and front cover (approx 7mm), remove a hook of the front cover and use a space become available.  
For wiring of **the FR-A700 series 30K\* or more and the FR-F700 series 37K\* or more**, use the space on the left side of the control circuit terminal block.

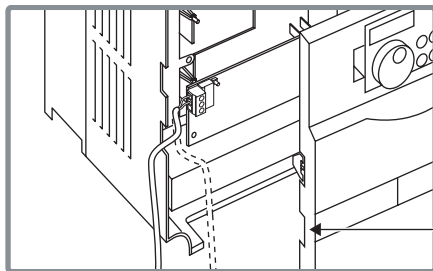

**FR-A700 series 22K or less  
and FR-F700 series 30K or less**

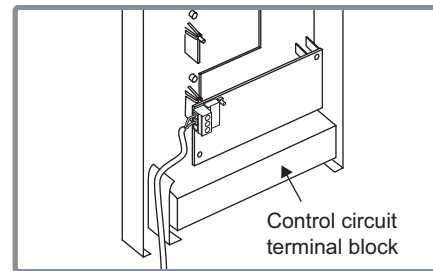
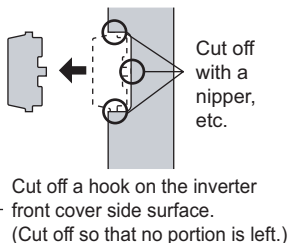

**FR-A700 series 30K or more  
and FR-F700 series 37K or more**

\* The inverter type of 22K and 30K of FR-A700 series, 30K and 37K of FR-F700 series in each -NA, -EC versions are as follows.



	NA	EC
FR-A700 series 22K (FR-A720-22K, FR-A740-22K)	FR-A720-00900-NA	—
	FR-A740-00440-NA	FR-A740-00620-EC
FR-A700 series 30K (FR-A720-30K, FR-A740-30K)	FR-A720-01150-NA	—
	FR-A740-00570-NA	FR-A740-00770-EC
FR-F700 series 30K (FR-F720-30K, FR-F740-30K)	FR-F720-01250-NA	—
	FR-F740-00620-NA	FR-F740-00620-EC
FR-F700 series 37K (FR-F720-37K, FR-F740-37K)	FR-F720-01540-NA	—
	FR-F740-00770-NA	FR-F740-00770-EC



### REMARKS

- When the hook of the inverter front cover is cut off for wiring, the protective structure (JEM1030) changes to open type (IP00).

### CAUTION

-  **When performing wiring using the space between the inverter front cover and control circuit terminal block, take care not to subject the cable to stress.**
-  **After wiring, wire offcuts must not be left in the inverter. They may cause an error, failure or malfunction.**

# 4 INVERTER SETTING

## 4.1 Parameter List

The following parameters are used for the communication option (FR-A7NL)  
Perform setting as required.

Parameter Number	Name	Setting Range	Minimum Setting Increments	Initial Value	Refer to Page
79	Operation mode selection	0 to 4, 6, 7	1	0	17
338	Communication operation command source	0, 1	1	0	20
339	Communication speed command source	0, 1, 2	1	0	20
340	Communication startup mode selection	0, 1, 2, 10, 12	1	0	17
342	Communication EEPROM write selection	0, 1	1	0	24
349 *1	Communication reset selection	0, 1	1	0	32
387 *1	Initial communication delay time	0 to 120s	0.1s	0s	80
388 *1	Heartbeat send time interval	0 to 999.8s	0.1s	0s	84
389 *1	Minimum heartbeat send time	0 to 999.8s	0.1s	0.5s	84
390 *1	% set reference frequency	1 to 400Hz	0.01Hz	60Hz/50Hz *2	82
391 *1	Heartbeat receive time interval	0 to 999.8s	0.1s	0s	94
392 *1	Event driven detection width	0.00 to 163.83%	0.01%	0%	99
500 *1	Communication error execution waiting time	0 to 999.8s	0.1s	0	25
501 *1	Communication error occurrence count display	0	1	0	26
502 *1	Stop mode selection at communication error	0, 1, 2, 3	1	0	27
550	NET mode operation command source selection	0, 1, 9999	1	9999	20

\*1 Parameters which can be displayed when the plug-in option (FR-A7NL) is mounted.

\*2 60Hz for the Japanese and NA version and 50Hz for the EC and CH version.



## **4.2 Operation Mode Setting**

The inverter mounted with a communication option has three operation modes.

- (1) PU operation [PU]..... Controls the inverter from the key of the operation panel (FR-DU07) mounted on the inverter.
- (2) External operation [EXT] ... Controls the inverter by switching on/off external signals connected to the control circuit terminals of the inverter.  
(The inverter is factory-set to this mode.)
- (3) Network operation [NET] ... Controls the inverter with instructions from the network via the communication option.  
(The operation signal and running frequency can be entered from the control circuit terminals depending on the *Pr. 338 Communication operation command source* and *Pr. 339 Communication speed command source* setting.  
*Refer to page 21.*)

### **4.2.1 Operation mode indication**

FR-DU07

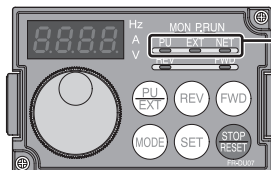

Operation mode indication  
(The inverter operates according to the LED lit mode.)

- PU: PU operation mode
- EXT: External operation mode
- NET: Network operation mode

## 4.2.2 Operation mode switching and communication startup mode (Pr. 79, Pr. 340)

### (1) Operation mode switching conditions

Before switching the operation mode, check that:

- 1) The inverter is at a stop;
- 2) Both the STF and STR signals are off; and
- 3) The *Pr. 79 Operation mode selection* setting is correct.

(Set with the operation panel of the inverter.)

Refer to *the inverter manual (applied)* for details of *Pr. 79*.

### (2) Operation mode selection at power on and at restoration from instantaneous power failure

The operation mode at power on and at restoration from instantaneous power failure can be selected.

Set a value other than "0" in *Pr. 340* to select the network operation mode.

After started in network operation mode, parameter write from the network is enabled.

#### REMARKS

1. Change of the *Pr. 340* setting is made valid when powering on or resetting the inverter.
2. *Pr. 340* can be changed with the operation panel independently of the operation mode.





Pr. 340 Setting	Pr. 79 Setting	Operation Mode at Power on or Power Restoration	Operation Mode Switchover
0 (initial value)	0 (initial value)	External operation mode	Switching among the external, PU, and NET operation mode is enabled *1
	1	PU operation mode	PU operation mode fixed
	2	External operation mode	Switching between the external and Net operation mode is enabled Switching to the PU operation mode is disallowed
	3, 4	External/PU combined operation mode	Operation mode switching is disallowed
	6	External operation mode	Switching among the external, PU, and NET operation mode is enabled while running.
	7	X12 (MRS) signal ON ..... external operation mode	Switching among the external, PU, and NET operation mode is enabled *1
		X12 (MRS) signal OFF ... external operation mode	External operation mode fixed (Forcibly switched to external operation mode.)
1, 2 *2	0	NET operation mode	Same as when Pr. 340 = "0"
	1	PU operation mode	
	2	NET operation mode	
	3, 4	External/PU combined operation mode	
	6 *4	NET operation mode	
	7	X12 (MRS) signal ON .... NET operation mode	
		X12 (MRS) signal OFF ... external operation mode	
10, 12 *2	0	NET operation mode	Switching between the PU and NET operation mode is enabled *3
	1	PU operation mode	Same as when Pr. 340 = "0"
	2	NET operation mode	NET operation mode fixed
	3, 4	External/PU combined operation mode	Same as when Pr. 340 = "0"
	6 *4	NET operation mode	Switching between the PU and NET operation mode is enabled while running *3
	7	External operation mode	Same as when Pr. 340 = "0"

\*1 Operation mode can not be directly changed between the PU operation mode and network operation mode.

\*2 The Pr. 340 settings "2, 12" are mainly used for communication operation using the inverter RS-485 terminal.

When a value other than "9999" (selection of automatic restart after instantaneous power failure) is set in Pr. 57 Restart coasting time, the inverter will resume the same operation state which was in before after power has been restored from an instantaneous power failure.

When Pr.340 = "1, 10", a start command turns off if power failure has occurred and then restored during a start command is on.

\*3 Operation mode can be changed between the PU operation mode and network operation mode with  of the operation panel (FR-DU07) and X65 signal.

\*4 Pr. 79 = "6" and Pr. 128 to Pr. 134 (PID control) are not activated simultaneously. Switchover mode and PID control are made invalid, and the inverter performs the same operation as when "0" is set in Pr. 79.

### (3) Operation mode switching method

When "0, 1, or 2" is set in Pr. 340

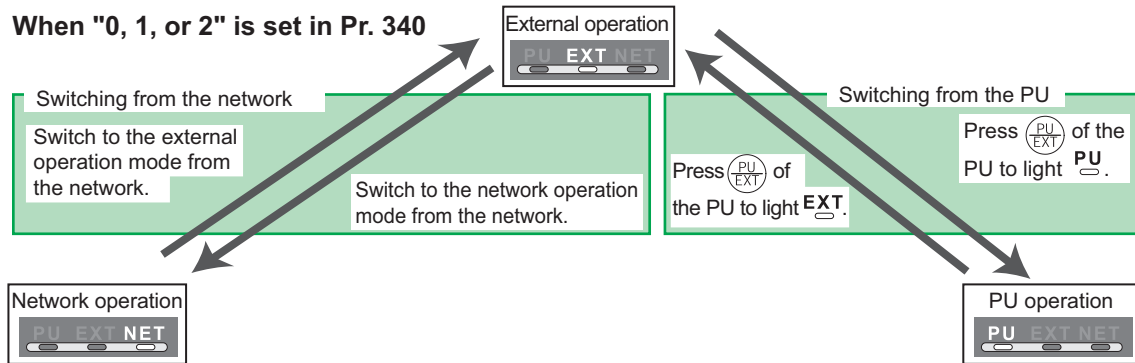

When "10 or 12" is set in Pr. 340

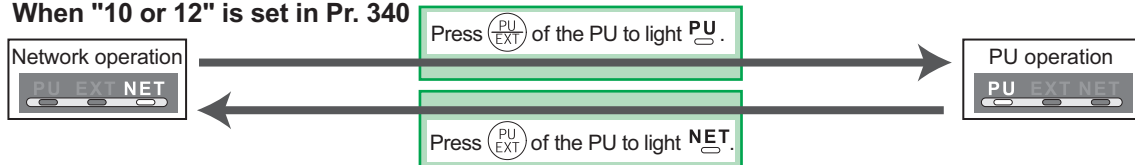

For the switching method from the external terminal, refer to *the inverter manual (applied)*.  
Refer to *page 43* and *75* for a switching method from the network.

#### CAUTION

- When starting the inverter in network operation mode at powering on or an inverter reset, set a value other than 0 in Pr. 340. (Refer to page 17)
- When setting a value other than 0 in Pr. 340, make sure that the initial settings of the inverter are correct.



### **4.3 Operation and Speed Command Source (Pr. 338, Pr. 339, Pr. 550)**

**(1) Select control source for the network operation mode (Pr. 550)**

A control location for the network operation mode can be selected from either the inverter RS-485 terminal or communication option.

When using a communication option, set "0 or 9999 (initial value)" in Pr. 550.

Parameter Number	Name	Initial Value	Setting Range	Description
550	NET mode operation command source selection	9999	0	Control source of the communication option is valid (control source of the inverter RS-485 terminal is invalid)
			1	Control source of the inverter RS-485 terminal is valid (control source of the communication option is invalid)
			9999	Automatic recognition of the communication option Normally, control source of the RS-485 terminal is valid. When a communication option is mounted, the control source of the communication option is valid.

*Refer to the inverter manual (applied) for details.*

## (2) Selection of control source for the network operation mode (Pr. 338, Pr. 339)

- As control sources, there are operation command source that controls signals related to the start command and function selection of the inverter and speed command source that controls signals related to frequency setting.
- In network operation mode, commands from the external terminals and communication are as listed below.

Control Location Selection	Pr. 338 Communication operation command source			0:NET			1:External			Remarks
	Pr. 339 Communication speed command source			0:NET	1: External	2: External	0:NET	1: External	2: External	
Fixed functions (Functions equivalent to terminals)	Running frequency from communication			NET	—	NET	NET	—	NET	
	Terminal 2			—	External	—	—	External	—	
	Terminal 4			—	External		—	External		
	Terminal 1			Compensation						
Selective functions Pr. 178 to Pr. 189 settings	0	RL	Low-speed operation command/remote setting clear	NET	External		NET	External		Pr. 59 = "0" (multi-speed) Pr. 59 = "1, 2" (remote)
	1	RM	Middle-speed operation command/remote setting deceleration	NET	External		NET	External		
	2	RH	High-speed operation command/remote setting acceleration	NET	External		NET	External		
	3	RT	Second function selection	NET			External			
	4	AU	Terminal 4 input selection	—	Combined		—	Combined		
	5	JOG	Jog operation selection	—			External			
	6	CS	Automatic restart after instantaneous power failure selection	External						
	7	OH	External thermal relay input	External						
	8	REX	15-speed selection	NET	External		NET	External		Pr. 59 = "0" (multi-speed)
	9	X9	Third function *1	NET			External			
10	X10	Inverter operation enable signal	External							



Control Location Selection	Pr. 338 Communication operation command source		0:NET			1:External			Remarks	
	Pr. 339 Communication speed command source		0:NET	1: External	2: External	0:NET	1: External	2: External		
Selective functions Pr. 178 to Pr. 189 settings	11	X11	FR-HC connection, instantaneous power failure detection	External						
	12	X12	PU operation external interlock	External						
	13	X13	External DC injection brake operation is started *3	NET			External			
	14	X14	PID control valid terminal	NET	External		NET	External		
	15	BRI	Brake opening completion signal *1	NET			External			
	16	X16	PU operation-external operation switching	External						
	17	X17	Load pattern selection forward rotation reverse rotation boost *1	NET			External			
	18	X18	V/F swichover *1	NET			External			
	19	X19	Load torque high speed frequency *1	NET			External			
	20	X20	S-pattern acceleration/deceleration C switching terminal *1	NET			External			
	22	X22	Orientation command *1, *2	NET			External			
	23	LX	Pre-excitation *1	NET			External			
	24	MRS	Output stop	Combined			External			Pr. 79 ≠ "7"
			PU operation interlock	External						Pr. 79 = "7" When the X12 signal is not assigned
	25	STOP	Start self-holding selection	—			External			
	26	MC	Control mode swichover *1	NET			External			
	27	TL	Torque limit selection *1	NET			External			
	28	X28	Start time tuning *1	NET			External			
	37	X37	Traverse function selection *4	NET			External			
	42	X42	Torque bias selection 1 *1, *2	NET			External			
43	X43	Torque bias selection 2 *1, *2	NET			External				
44	X44	P/PI control swichover *1	NET			External				

Control Location Selection		Pr. 338 Communication operation command source		0:NET			1:External			Remarks	
		Pr. 339 Communication speed command source		0:NET	1: External	2: External	0:NET	1: External	2: External		
Selective functions	Pr. 178 to Pr. 189 settings	50	SQ	Sequence start *5	NET			External			
		60	STF	Forward rotation command	NET			External			
		61	STR	Reverse rotation command	NET			External			
		62	RES	Reset				External			
		63	PTC	PTC thermistor selection				External			
		64	X64	PID forward rotation action switchover	NET	External		NET	External		
		65	X65	PU/NET operation switchover				External			
		66	X66	NET/external operation switchover				External			
		67	X67	Command source switchover				External			
		68	NP	Conditional position pulse train sign *1, *2				External			
		69	CLR	Conditional position droop pulse clear *1, *2				External			
		70	X70	DC feeding operation permission *1	NET			External			
		71	X71	DC feeding cancel *1	NET			External			

\*1 Setting can be made only for the FR-A700 series.

\*2 Available only when used with the FR-A7AP.

\*3 For the FR-F700 series, setting can be made only for the EC and NA versions.

\*4 Setting can be made only for the EC and CH versions.

\*5 Setting can be made only for the FR-A700 series NA and EC versions.

[Explanation of table]

External :Control by signal from external terminal is only valid.

NET :Control from network is only valid

Combined :Operation from either external terminal or communication is valid.

— :Operation from either external terminal or computer is invalid.

Compensation :Control by signal from external terminal is only valid if Pr. 28 Multi-speed input compensation setting is "1".



### 4.3.1 Communication EEPROM write selection (Pr. 342)

When parameter write is performed from the communication option, write to RAM is enabled. Set when frequent parameter changes are necessary.

Parameter Number	Name	Initial Value	Setting Range	Description
342	Communication EEPROM write selection	0	0	Parameter values written by communication are written to the EEPROM and RAM.
			1	Parameter values written by communication are written to the RAM.

- When changing the parameter values frequently, set "1" in *Pr. 342* to write them to the RAM. Performing frequent parameter write with "0 (initial value)" (EEPROM write) set in will shorten the life of the EEPROM.

#### REMARKS

When "1" is set in *Pr. 342* (write to RAM only), powering off the inverter will erase the changed parameter values. Therefore, the parameter values available when power is switched on again are the values stored in EEPROM previously.

## 4.4 Operation at Communication Error Occurrence

### 4.4.1 Operation selection at communication error occurrence (Pr. 500 to Pr. 502)

You can select operations at communication error occurrences by setting *Pr. 500 to Pr. 502* under network operation.

#### (1) The set time from when a communication line error occurrence until communication error output

You can set the waiting time from when a communication line error occurs until it is recognized as a communication error.

Parameter Number	Name	Setting Range	Minimum Setting Increments	Initial Value
500	Communication error execution waiting time	0 to 999.8s	0.1s	0

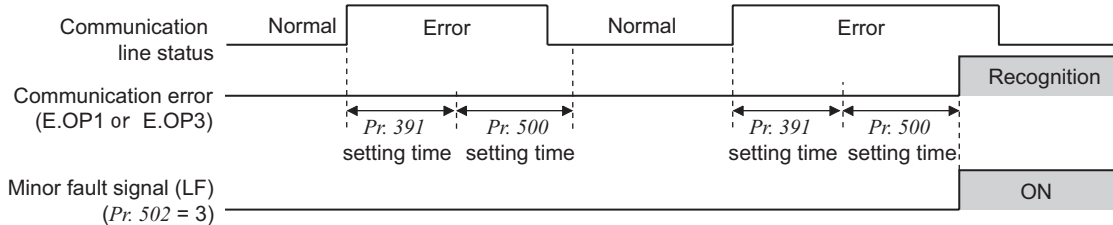

If the communication line error still persists after the time set in *Pr. 500* has elapsed, it is recognized as a communication error.

When the error is restored to normal communication within the set time, it is not regarded as a communication error and operation continues.

#### REMARKS

For detection of communication error, set the heartbeat receive time interval (*Pr. 391*) and set the send time interval from the other node shorter than the heartbeat receive time interval.

When data is not received for more than the heartbeat receive time interval after the first reception, it is considered as a communication line error, then "option alarm (E.OP1 or E.OP3)" is displayed and the inverter stops. (Refer to page 94.)





**(2) Display and erasure of communication error occurrence count**

The cumulative number of communication error occurrences can be indicated.

Write "0" to erase this cumulative count.

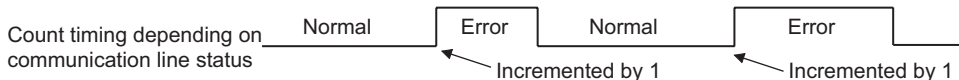
Parameter Number	Name	Setting Range	Minimum Setting Increments	Initial Value
501	Communication error occurrence count display	0	1	0



At the point of communication line error occurrence, *Pr. 501 Communication error occurrence count display* is incremented by 1.

---

**CAUTION**

---

**The communication error count occurrence is stored into RAM temporarily. Since this data is stored in EEPROM at one-hour intervals, performing power-on reset or inverter may cause the *Pr. 501* data to be the value stored in EEPROM the last time depending on the reset timing.**

---

**(3) Inverter operation selection at communication error occurrence**

You can select the inverter operation if a communication line error or an error of the option unit itself occurs.

Parameter Number	Name	Setting Range	Minimum Setting Increments	Initial Value
502	Stop mode selection at communication error	0, 1, 2, 3	1	0

**About setting****●Operation at error occurrence**

Alarm Definition	Pr. 502 Setting	Operation	Indication	Alarm Output
Communication line	0	Continued *	Normal indication *	Not provided *
	1			
	2			
	3			
Communication option itself	0, 3	Coast to stop	E. 1 or E. 3 lit	Provided
	1, 2	Decelerated to stop	E. 1 or E. 3 lit after stop	Provided after stop

\*When the error returns to normal communication within the time set in Pr. 500, it is not regarded as a communication line error (E.OP1 or E.OP3).

**●Operation at error recognition after elapse of Pr. 500 time**

Alarm Definition	Pr. 502 Setting	Operation	Indication	Alarm Output
Communication line	0	Coast to stop	E.OP1 or E.OP3 lit	Provided
	1	Decelerated to stop	E.OP1 or E.OP3 lit after stop	Provided after stop
	2			Not provided
	3	Continued	Normal indication	
Communication option itself	0, 3	Coast to stop	E. 1 or E.3 lit	Provided
	1, 2	Decelerated to stop	E. 1 or E.3 lit after stop	Provided after stop

**● Operation at error removal**

Alarm Definition	Pr. 502 Setting	Operation	Indication	Alarm Output
Communication line	0	Kept stopped	E.OP1 or E.OP3 kept lit	Kept provided
	1			
	2	Restart	Normal indication	Not provided
	3	Continued		
Communication option itself	0, 3	Kept stopped	E. 1 or E.3 kept lit	Kept provided
	1, 2			

---

**CAUTION**

---

1. A communication line error [E.OP1 (alarm data: HA1), E.OP3 (alarm data: HA3)] is an error that occurs on the communication line, and an error of the communication option unit itself [E. 1 (alarm data: HF1), E. 3 (alarm data: HF3)] is a communication circuit error in the option.
  2. The alarm output indicates alarm output signal (terminal ABC1) or alarm bit output.
  3. When the setting was made to provide an alarm output, the error definition is stored into the alarm history. (The error definition is written to the alarm history when an alarm output is provided.)  
When no alarm output is provided, the error definition overwrites the alarm indication of the alarm history temporarily, but is not stored.  
After the error is removed, the alarm indication is reset and returns to the ordinary monitor, and the alarm history returns to the preceding alarm indication.
  4. When the Pr. 502 setting is "1" or "2", the deceleration time is the ordinary deceleration time setting (e.g. Pr. 8, Pr. 44, Pr. 45).
  5. The acceleration time at a restart is the ordinary acceleration time setting (e.g. Pr. 7, Pr. 44).
  6. When the Pr. 502 setting is "2", the operation/speed command at a restart is the one given before the error occurrence.
  7. When a communication line error occurs at the Pr. 502 setting of "2", removing the error during deceleration causes acceleration to restart at that point. (Acceleration is not restarted if the error is that of the option unit itself.)
-

#### 4.4.2 Alarm and measures

(1) The inverter operates as follows at alarm occurrences.

Alarm Location	Status		Operation Mode		
			Network Operation	External Operation	PU Operation
Inverter	Inverter operation		<b>Inverter trip</b>	Inverter trip	Inverter trip
	Data communication		<b>Continued</b>	Continued	Continued
Communication line	Inverter operation		<b>Inverter trip (depends on the Pr. 502 setting)</b>	Continued	Continued
	Data communication		<b>Stop</b>	Stop	Stop
Communication option	Communication option connection error	Inverter operation	<b>Inverter trip (depends on the Pr. 502 setting)</b>	Inverter trip (depends on the Pr. 502 setting)	Inverter trip (depends on the Pr. 502 setting)
		Data communication	<b>Continued</b>	Continued	Continued
	Error of communication option itself	Inverter operation	<b>Inverter trip (depends on the Pr. 502 setting)</b>	Continued	Continued
		Data communication	<b>Stop</b>	Stop	Stop

**(2) Measures at alarm occurrences**

<b>Alarm Indication</b>	<b>Alarm Definition</b>	<b>Measures</b>
E.OP1, E.OP3	Communication line error	Check the LED status of the option unit and remove the cause of the alarm. (Refer to <i>page 5</i> for LED indication status) Check the other nodes on the network. Inspect the master.
E.1, E.2, E.3	Option alarm	Check the connection between the inverter and option unit for poor contact, etc. and remove the cause of the error. For the FR-A700 series, fit the communication option in the option connector 3.

When alarms other than the above are displayed, refer to the inverter manual and remove the cause of the alarm.

## 4.5 Inverter Reset

### (1) Operation conditions of inverter reset

Which resetting method is allowed or not allowed in each operation mode is described below.

Resetting Method			Operation Mode		
			Network Operation	External Operation	PU Operation
Reset from the network	Inverter reset (Command request network variable) (Refer to page 74) *1		Enabled	Disabled	Disabled
	Error reset at inverter fault (Inverter input signal network variable) (Refer to page 56) *2	Pr.349 = 0	Enabled	Enabled	Enabled
		Pr.349 = 1		Disabled	Disabled
Turn on the terminal RES (RES signal)			Enabled	Enabled	Enabled
Switch off inverter power			Enabled	Enabled	Enabled
Reset from the PU/DU	Inverter reset		Enabled	Enabled	Enabled
	Reset at inverter fault		Enabled	Enabled	Enabled

\*1 Inverter reset can be made any time.

\*2 Reset can be made only when the protective function of the inverter is activated.

### CAUTION

- When a communication line error has occurred, reset cannot be made from the network.
- The inverter is set to the external operation mode if it has been reset in network operation mode. To resume the network operation, the inverter must be switched to the network operation mode again. Set a value other than "0" in Pr. 340 to start in network operation mode. (Refer to page 17.)
- The inverter can not be controlled for about 1s after release of a reset command .

**(2) Error reset operation selection at inverter fault**

When used with the communication option (FR-A7NL), an error reset command\* from network can be made invalid in the external operation mode or PU operation mode.

Parameter Number	Name	Initial Value	Setting Range	Function
349	Communication reset selection	0	0	Error reset* is enabled independently of operation mode
			1	Error reset* is enabled only in the network operation mode

\*nvilnvAlarmReset (Refer to page 56.)

# 5 FUNCTION OVERVIEW

## 5.1 XIF File

---

Using the configuration software, network setting is easily done.

To use the configuration software, an XIF file is necessary. XIF file is used to recognize device features and functions. For details of installation and XIF file usage, refer to the configuration software manual.

XIF file can be downloaded from

Mitsubishi Electric FA Network Service MELFANS web

<http://www.MitsubishiElectric.co.jp/melfansweb> or obtained from your sales representative.

---

### CAUTION

---

**Since memory for write enable application is not installed in the inverter, Mitsubishi does not provide application files (file extensions such as .nxe, .apb).**

---

---





## 5.2 Output from the Inverter to the Network

Main items to be output from the inverter (FR-A7NL) to the network and their descriptions are explained below.

Item	Description	Refer to Page
Object status	You can check the condition of the node.	44
Speed monitor	You can monitor the output frequency in 0.005% increments.	47
Inverter output signal	You can monitor the output terminal status of the inverter.	49
Output frequency monitor	You can monitor the output frequency in 0.1/0.01Hz or 0.005% increments.	52, 53, 73
Output current monitor	You can monitor the output current in 0.1A increments.	54
Output voltage monitor	You can monitor the output voltage in 0.1V increments.	54
Actual operation time monitor	You can monitor the actual operation time of the inverter.	54
Cumulative power monitor	You can monitor the cumulative power of the inverter.	55
Alarm occurrence definition	At inverter alarm occurrence, you can confirm the alarm definition.	57
Product information	You can output the maker name and type as a character string.	60
Emergency stop status	You can confirm the emergency stop status of the inverter.	62
Alarm status	You can check whether the inverter is in the alarm status or not.	63
Monitor data	You can check the monitor value corresponding to the monitor code set.	72
Command response	You can check the reply to command requests, e.g. operation mode selection, parameter write, inverter reset, from the inverter.	79

### REMARKS

Refer to *the inverter manual (applied)* for functions controllable from the network in each operation mode.

## 5.3 Input from the Network to the Inverter

Main items which can be commanded from the network to the inverter and their descriptions are explained below.

Item	Description	Refer to Page
Object request	You can make a request to know the object status.	43
Start and stop/simple speed setting	You can perform start/stop and simple frequency setting.	45
Speed adjustment	You can perform frequency setting in 0.005% increments.	46
Inverter input signal	You can execute functions assigned to the inverter input terminals.	48
Set frequency write destination selection	You can select either of RAM or EEPROM as the write destination of set frequencies.	50
Set frequency	You can set the set frequency in 0.1/0.01Hz or 0.005% increments.	51, 73
Alarm reset	You can reset the inverter at an inverter alarm occurrence.	56
Emergency stop command	You can make an emergency stop of the inverter.	61
PID set point	You can input the set point for PID control.	65
PID measured value	You can input the current measured value for PID control.	66
PID deviation	You can input the current deviation for PID control.	67
Monitor code	You can input a code to select a monitor type.	68
Command request	You can make command requests, e.g. operation mode selection, parameter write, inverter reset, to the inverter.	74
Initial communication delay time	You can set the time from when the inverter starts until when data is sent to the network.	80
Forward/reverse rotation prevention	You can prevent rotation in the wrong direction.	81
% setting reference frequency	You can set the reference frequency of set frequency (nvInvSetFreqP) and output frequency (nvInvOutFreqP).	82
Maximum frequency	You can set the maximum frequency of the inverter.	83
Minimum frequency	You can set the minimum frequency of the inverter.	83



Item	Description	Refer to Page
Heartbeat send time interval	You can set the heartbeat send time interval of output network variables.	84
Minimum heartbeat send time	You can set the minimum heartbeat send time of output network variables.	84
Acceleration time	You can set the motor acceleration time.	87
Deceleration time	You can set the motor deceleration time.	88
PID action selection	You can choose the operation of PID control.	89
PID proportional band	You can set the proportional band for PID control.	91
PID integral time	You can set the integral time for PID control.	91
PID differential time	You can set the differential time for PID control.	92
PID manipulated bias	You can set the manipulated variable at 0%.	92
PID manipulated gain	You can set the manipulated variable at 100%.	93
Heartbeat receive time interval	You can set the heartbeat receive time interval of input network variables.	94
Maximum speed	You can set the maximum speed of the inverter.	96
Minimum speed	You can set the minimum speed of the inverter.	96
Reference speed setting	You can set the reference speed of maximum speed, minimum speed, speed adjustment, speed monitor.	97
Reference frequency setting	You can set the reference frequency of maximum speed, minimum speed, speed adjustment, speed monitor.	98
Default value of speed adjustment	You can set the default value of speed adjustment.	98
Event driven detection width	You can set the event driven detection width of the monitor-related output network variables.	99

**REMARKS**

Refer to *the inverter manual (applied)* for functions controllable from the network in each operation mode.

# 6 NETWORK VARIABLES

## 6.1 Object Map

This chapter describes detailed object definitions for use of LONWORKS system.

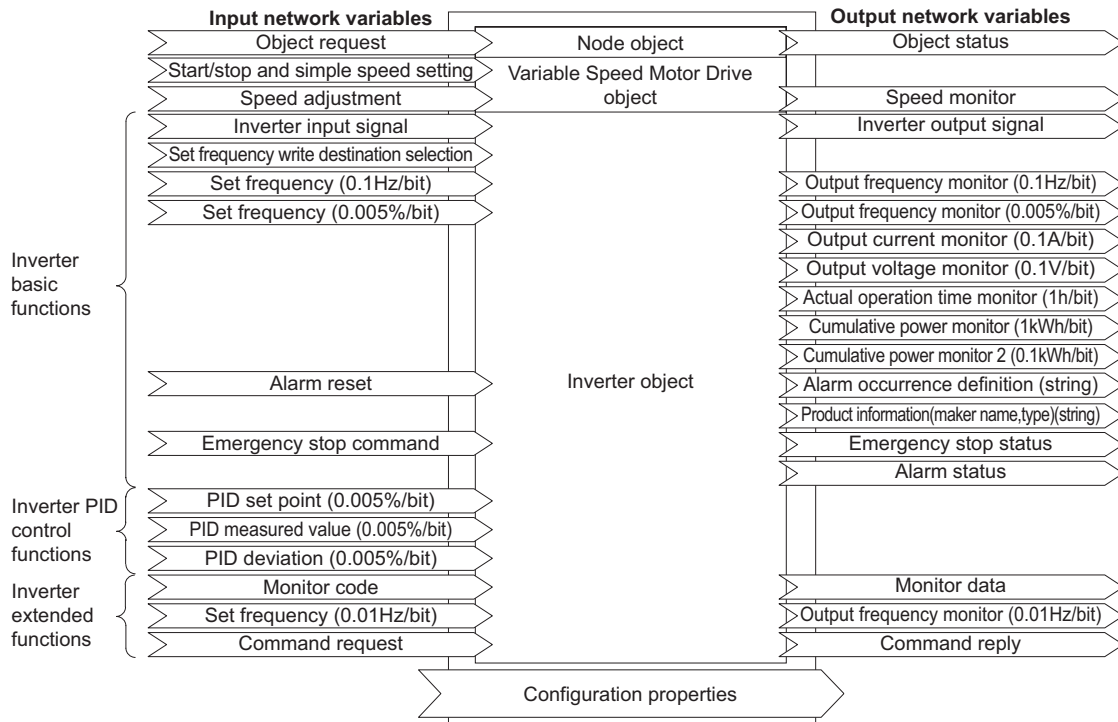



## 6.2 Network Variable List

No.	Type	Function	Network Variables		In/ Out	Setting Value Storage Location	Size (byte)	Initial Value	Refer to Page	
			Variables	Name						
1	SN	Object request	SNVT_obj_request	nviRequest	In	—	3	H0	43	
2	SN	Object status	SNVT_obj_status	nvoStatus	Out		6	H0	44	
3	SN	Start/stop and simple speed setting	SNVT_switch	nviDrvSpeedStpt	In		2	state=HFF value=0	45	
4	SN	Speed adjustment	SNVT_lev_percent	nviDrvSpeedScale	In		2	100.00%	46	
5	SN	Speed monitor	SNVT_lev_percent	nvoDrvSpeed	Out		2	0.000%	47	
6	SN	Inverter input signal	SNVT_state	nviInvInputSig	In		2	0	48	
7	SN	Inverter output signal	SNVT_state	nvoInvOutputSig	Out		2	H8000	49	
8	SN	Set frequency write destination selection	SNVT_switch	nviInvSetFreqSw	In		2	state=H0 value=0	50	
9	SN	Set frequency (0.1Hz/bit) *1	SNVT_freq_hz	nviInvSetFreq	In		RAM/ EEPROM of the inverter	2	H7FFF	51
10	SN	Set frequency (0.005%/bit)	SNVT_lev_percent	nviInvSetFreqP	In		2	100.00%	51	
11	SN	Output frequency monitor (0.1Hz/bit) *1	SNVT_freq_hz	nvoInvOutFreq	Out	—	2	0.0Hz	52	
12	SN	Output frequency monitor (0.005%/bit)	SNVT_lev_percent	nvoInvOutFreqP	Out		2	0.000%	53	
13	SN	Output current monitor (0.1A/bit) *1	SNVT_amp	nvoDrvCurnt	Out		2	0.0A	54	
14	SN	Output voltage monitor (0.1V/bit) *1	SNVT_volt	nvoDrvVolt	Out		2	0.0V	54	
15	SN	Actual operation time monitor (1 h/bit)	SNVT_time_hour	nvoDrvRunHours	Out	EEPROM of the inverter	2	0h	54	
16	SN	Cumulative power monitor(1kWh/bit)	SNVT_elec_kwh	nvoDrvRunPower	Out	2	0kWh	55		

SN = SNVT (Standard network variables)  
SC = SCPT (Configuration property)

No.	Type	Function	Network Variables		In/ Out	Setting Value Storage Location	Size (byte)	Initial Value	Refer to Page	
			Variables	Name						
17	SN	Alarm reset	SNVT_switch	nvilnvAlarmReset	In	—	2	state=H0 value=H0	56	
18	SN	Alarm occurrence definition (string)	SNVT_str_asc	nvolnvAlarmStr	Out		31	0	57	
19	SN	Product information (maker name, type) (string)	SNVT_str_asc	nvolnvTypeInfo	Out		31	MITSUBISHI FR-A7NL	60	
20	SN	Emergency stop command	SNVT_hvac_emerg	nviEmergOverride	In		1	H0	61	
21	SN	Emergency stop status	SNVT_hvac_emerg	nvoEmergStatus	Out		1	H0	62	
22	SN	Alarm status	SNVT_switch	nvoDrvAlarm	Out		2	state=H0 value=H0	63	
23	SN	PID set point (0.005%/bit)	SNVT_lev_percent	nvilnvPIDTarget	In		2	0.000%	65	
24	SN	PID measured value (0.005%/bit)	SNVT_lev_percent	nvilnvPIDValue	In		2	0.000%	66	
25	SN	PID deviation (0.005%/bit)	SNVT_lev_percent	nvilnvPIDDev	In		2	0.000%	67	
26	SN	Monitor code	SNVT_count	nvilnvMonCode	In		2	0	68	
27	SN	Monitor data	SNVT_count	nvolnvMonData	Out		2	0	72	
28	SN	Set frequency (0.01Hz/bit)	SNVT_count	nvilnvSetFreq2	In		RAM/ EEPROM of the inverter	2	0.00Hz	73
29	SN	Output frequency monitor (0.01Hz/bit)	SNVT_count	nvolnvOutFreq2	Out		—	2	0.00Hz	73
30	SN	Command request	SNVT_str_asc	nvilnvCmdReq	In	31		0	74	
31	SN	Command reply	SNVT_str_asc	nvolnvCmdReply	Out	31		0	79	
32	SC	Initial communication delay time (0.1s/bit)	SNVT_time_sec	nciPwUpOutTm	In	Pr. 387	2	0s	80	

SN = SNVT (Standard network variables)  
SC = SCPT (Configuration property)



No.	Type	Function	Network Variables		In/ Out	Setting Value Storage Location	Size (byte)	Initial Value	Refer to Page
			Variables	Name					
33	SC	Forward/reverse rotation prevention	SNVT_count	nciInvFwdRevLock	In	Pr. 78	2	*2	81
34	SC	% set reference frequency (0.1Hz/bit) * <sub>1</sub>	SNVT_freq_hz	nciInvSetFreqBas	In	Pr. 390	2	60Hz <50Hz> * <sub>3</sub>	82
35	SC	Maximum frequency (0.1Hz/bit) * <sub>1</sub>	SNVT_freq_hz	nciInvMaxFreq	In	Pr. 1	2	*2	83
36	SC	Minimum frequency (0.1Hz/bit) * <sub>1</sub>	SNVT_freq_hz	nciInvMinFreq	In	Pr. 2	2	*2	83
37	SC	Heartbeat send time interval (0.1s/bit)	SNVT_time_sec	nciSndHrtBt	In	Pr. 388	2	0	84
38	SC	Minimum heartbeat send time (0.1s/bit)	SNVT_time_sec	nciMinOutTm	In	Pr. 389	2	0.5s	84
39	SC	Acceleration time (0.1s/bit)	SNVT_time_sec	nciRampUpTm	In	Pr. 7	2	*2	87
40	SC	Deceleration time (0.1s/bit)	SNVT_time_sec	nciRampDownTm	In	Pr. 8	2	*2	88
41	SC	PID action selection	SNVT_count	nciInvPIDSwitch	In	Pr. 128	2	*2	89
42	SC	PID proportional band (0.1%/bit)	SNVT_count	nciInvPIDPro	In	Pr. 129	2	*2	91
43	SC	PID integral time (0.1s/bit)	SNVT_time_sec	nciInvPIDIntTm	In	Pr. 130	2	*2	91
44	SC	PID differential time (0.1s/bit) * <sub>1</sub>	SNVT_time_sec	nciInvPIDDiffTm	In	Pr. 134	2	*2	92
45	SC	PID manipulated variable bias (0.1Hz/bit) * <sub>1</sub>	SNVT_freq_hz	nciInvPIDOpeBias	In	C2 (Pr. 902)	2	*2	92
46	SC	PID manipulated variable gain (0.1Hz/bit) * <sub>1</sub>	SNVT_freq_hz	nciInvPIDOpeGain	In	Pr.125 (Pr. 903)	2	*2	93
47	SC	Heartbeat receive time interval (0.1s/bit)	SNVT_time_sec	nciRcvHrtBt	In	Pr. 391	2	0s	94
48	SC	Maximum speed (0.005%/bit)	SNVT_lev_percent	nciMaxSpeed	In	Pr. 1	2	*2	96
49	SC	Minimum speed (0.005%/bit)	SNVT_lev_percent	nciMinSpeed	In	Pr. 2	2	*2	96

SN = SNVT (Standard network variables)  
SC = SCPT (Configuration property)

No.	Type	Function	Network Variables		In/ Out	Setting Value Storage Location	Size (byte)	Initial Value	Refer to Page
			Variables	Name					
50	SC	Reference speed setting (1r/min/bit)	SNVT_rpm	nciNmlSpeed	In	Pr. 390	2	1800r/min <1500r/min> *3	97
51	SC	Reference frequency setting (0.1Hz/bit) *1	SNVT_freq_hz	nciNmlFreq	In	Pr. 390	2	60Hz <50Hz> *3	98
52	SC	Speed adjustment default value	SNVT_lev_percent	nciDrvSpeedScale	In	—	2	100.00%	98
53	SC	Event driven detection width (0.005%/bit)	SNVT_lev_percent	nciInvEvtDuty	In	Pr. 392	2	0%	99
54	SN	Cumulative power monitor 2 (0.1kWh/bit)	SNVT_elec_kwh_l	nvoDrvRunPower_l	Out	EEPROM of the inverter	4	0kWh	56
55 to 62	System reserved								

SN = SNVT (Standard network variables)  
SC = SCPT (Configuration property)

- \*1 Displayed in 0.01 increments on the operation panel (FR-DU07).
- \*2 Refer to the inverter manual for the corresponding parameter initial values.
- \*3 Values within parenthesis are initial values for EC and CH versions.

### REMARKS

Write conditions of configuration property is same as those of the inverter parameter. Write conditions are restricted by *Pr. 77 Parameter write selection*. When writing to configuration property during inverter operation, set "2" in *Pr. 77*. Refer to *the inverter manual (applied)* for details of *Pr. 77*.





## 6.3 LONWORKS Object

---

### 6.3.1 Setting range of object ID

The setting values of object ID are 0 to 4 and are as listed below.

When any values 5 to 65535 are set for object ID, invalid\_id bit of object status (nvoStatus) becomes 1 and a command set for object request is made invalid. (*Refer to page 44*)

Object ID	Description
0	Node object
1	VariableSpeedMotorDrive object [LONMARK object]
2	Inverter basic function
3	Inverter PID control function
4	Inverter extended function

### 6.3.2 Object request (network input SNVT\_obj\_request nviRequest)

You can make a request to get the object status.

Member Name		Description	Initial Value
object_id		Stores the object ID.	
object_request	H0	RQ_NORMAL	In external operation mode *3, it shifts to the network operation mode.
	H1	RQ_DISABLED	Makes the inverter object invalid.
	H2	RQ_UPDATE_STATUS	Update object status (nvoStatus).
	H3	RQ_SELF_TEST	Not supported.*1
	H4	RQ_UPDATE_ALARM	Updates in_alarm bit of the object status (nvoStatus).
	H5	RQ_REPORT_MASK	Changes bit (invalid_id, invalid_request, disabled, manual_control, in_alarm, in_override, report_mask) supported by object status (nvoStatus) to "1".
	H6	RQ_OVERRIDE	Not supported.*1
	H7	RQ_ENABLE	Makes the inverter object valid.
	H8	RQ_RMV_OVERRIDE	Not supported.*1
	H9	RQ_CLEAR_STATUS	Clears all bits of the object status (nvoStatus) to "0".
	HA	RQ_CLEAR_ALARM	Clear in_alarm bit of object status (nvoStatus) to "0".*2
	HB	RQ_ALARM_NOTIFY_ENABLED	Not supported *1
	HC	RQ_ALARM_NOTIFY_DISABLED	
	HD	RQ_MANUAL_CTRL	Shifts the inverter to the external operation mode.
	HE	RQ_REMOTE_CTRL	Shifts the inverter to the network operation mode.
	HF	RQ_PROGRAM	Not supported.*1
HFF	RQ_NUL	Nothing is done.	
—	Other than the above	Not supported. *1	

\*1 Changes the invalid\_request of the object status (nvoStatus) to "1" when data is set. (Refer to page 44)

\*2 Use alarm reset (nviInvAlarmReset) to reset the alarm status of the inverter (Refer to page 56.)

\*3 Can also be switched from switchover mode. (For details of switchover mode, refer to the inverter manual.)



### 6.3.3 Object status (network output SNVT\_obj\_status nvoStatus)

You can indicate the condition of the node.

Member Name	Description	Initial Value
object_id	The setting value of object request (nviRequest) written to object_id is displayed.	H0
invalid_id	Changes to "1" if an illegal object ID is specified in object_id of the object request (nviRequest).	
invalid_request	Changes to "1" if object_request not supported by the object request (nviRequest) is set.	
disabled	Changes to "1" if the object of the inverter is invalid.	
out_of_limits	Not supported *1	
open_circuit		
out_of_service		
Mechanical_fault		
feedback_failure		
over_range		
under_range		
electrical_fault		
unable_to_measure		
comm_failure		
fail_self_test		
self_test_in_progress		
locked_out		
manual_control	Changes to "1" if the operation mode of the inverter is other than the network operation mode.	
in_alarm	Changes to "1" during the inverter is in the alarm status.	
in_override	Changes to "1" if the operation mode of the inverter is network operation mode and run command and speed command are not given via the network.	
report_mask	Not supported *1	
programming_mode		
programming_fail		
alarm_notify_disabled		

\*1 "0" is always set in the unsupported functions bit position.

## 6.4 Variable Speed Motor Drive Object

### 6.4.1 Start/stop and simple speed setting (network input SNVT\_switch nviDrvSpeedStpt)

You can set "start/stop" and "simple setting of set frequency".

- Set start/stop in state.

The rotation direction (forward/reverse rotation) is determined by whether "speed adjustment (nviDrvSpeedScale)" is positive or negative. (Refer to page 46)

- Set simple speed setting in value.

As the set frequency, set its ratio to "speed adjustment (nviDrvSpeedScale)" (0.5% increments).

nviDrvSpeedStpt		Operation *1	
State	Value	nviInvSetFreq = "H7FFF"	nviInvSetFreq = "0Hz to 400Hz"
H0	NA	Stop	
H1	0 (initial value)	Run at a 0% frequency.	
	0.5 to 100%	Run at a 0.5 to 100% frequency. (nciNmlFreq × nviDrvSpeedStpt × nviDrvSpeedScale)	Run at an nviInvSetFreq frequency.
H2 to HFF (initial value: HFF)	NA	No operation	

\*1 Operation of nviDrvSpeedStpt differs according to nviInvSetFreq. (Refer to page 51)

#### REMARKS

- The variable is initialized to "HFF" at power-on or if it is not updated at the "heartbeat receive time interval (nciRcvHrtBt)". (Refer to page 94)
- The inverter operates at 100% frequency even if the value exceeding "100%" is set when state = "H1".
- Updating nviDrvSpeedScale resets the start command depending on the state of nviDrvSpeedStpt.



### 6.4.2 Speed adjustment (0.005% increments) (network input SNVT\_lev\_percent nviDrvSpeedScale)

You can set the set frequency in 0.005% increments on the assumption that the frequency set in "reference frequency setting (nciNmiFreq)" is 100%. (Refer to page 98)

- When the state of nviDrvSpeedStpt is H1, the motor is placed in forward rotation status if nviDrvSpeed Scale value is positive and placed in reverse rotation status if the value is negative.
- When state of nviDrvSpeedStpt is H0, the motor is at a stop status.

Data Name	Initial Value	Range	Increments
nviDrvSpeedScale	100.00% (NciDrvSpeedScale value) (Refer to page 98)	-163.840% to 163.830%	0.005%/bit

- Data acceptance timing ..... At network variable receive (nv\_update\_occurs event)

The frequency to be written to the inverter actually is as shown in the following formula.

- Set frequency = | (reference frequency setting × speed adjustment × simple speed setting)|

Example:  
 When "Simple speed setting (nviDrvSpeed Stpt.value)" = 50%, "Reference frequency setting (nciNmiFreq)" = 60.0Hz, and "Speed adjustment (nviDrvSpeedScale)" = -150%, output frequency is (60.00Hz × (-150%) × 50%) = -45Hz. Therefore, a reverse command of 45Hz is given.

#### REMARKS

- The variable is initialized to "100.00%" at power-on or if it is not updated within the set "heartbeat receive time interval (nciRcvHrtBt)". (Refer to page 94)
- Control can not be exercised at less than the minimum frequency resolution (0.01Hz) of the inverter.
- To make the change of "reference frequency setting (nciNmiFreq)" reflected to the operation speed, a value is need to be written to speed adjustment (nviDrvSpeedScale)

### 6.4.3 Speed monitor (0.005% increments) (network output SNVT\_lev\_percent nvoDrvSpeed)

You can set the frequency command in 0.005% increments on the assumption that the frequency set in "reference frequency setting (nciNmiFreq)" is 100%. (Refer to page 98)

- A positive value indicates the motor is in the forward rotation status and a negative value indicates that the motor is in the reverse rotation status.

Data Name	Initial Value	Range	Increments
nvoDrvSpeed	0.000%	-163.840% to 163.830%	0.005%/bit

- Data send event ..... When data changes in 0.005% increments
- Data send timing ..... As set in Pr. 388 Heartbeat send time interval and Pr. 389 Minimum heartbeat send time. (Refer to page 84)

Output frequency is as shown in the following formula.

- Output frequency = | (reference frequency setting × speed monitor × simple speed setting) \*1|

\*1 Refer to page 98 for reference frequency setting and page 45 for simple speed setting.

Example:  
 When "simple speed setting(nviDrvSpeedStpt.value)" = 50%, "reference frequency setting(nciNmiFreq)" = 60.0Hz and "speed setting monitor(nvoDrvSpeed)" = -150%, output frequency is (60.0Hz × (-150%) × 50%) = -45Hz. Therefore, a reverse rotation of 45Hz is given.

#### REMARKS

- Monitoring is disabled at less than the minimum frequency resolution (0.01Hz) of the inverter.



## 6.5 Inverter Basic Functions

### 6.5.1 Inverter input signal (network input SNVT\_state nvInvInputSig)

A 16-bit-wide input signal to the inverter.

- The initial value of all bits are "0".
- Data acceptance timing ..... At network variable receive (nv\_update\_occurs event)

Bit	Signal Name	Description	
0	Forward rotation command	OFF :Stop command ON :Forward rotation start	A starting command is input to the inverter when the signal turns on. A stop command is given when both signals turn on simultaneously.
1	Reverse rotation command	OFF :Stop command ON :Reverse rotation start	
2	High-speed operation command (terminal RH function) *1	Functions assigned to terminals RH, RM, RL, JOG, RT, AU, CS, MRS, STOP, and RES are activated.	
3	Middle-speed operation command (terminal RM function) *1		
4	Low-speed operation command (terminal RL function) *1		
5	JOG operation command (terminal JOG function) *1		
6	Second function selection (terminal RT function) *1		
7	Current input selection (terminal AU function) *1		
8	Selection of automatic restart after instantaneous power failure (terminal CS function) *1		
9	Output stop (terminal MRS function) *1		
10	Start self-holding selection (terminal STOP function) *1		
11	Reset (RES terminal function) *1		
12 to 15	Not used	System reserved	

\*1 Signal names are initial values. Using Pr. 180 to Pr.189, you can change input signal functions. Note that some of signals do not accept a command from the network according to the Pr. 338 and Pr. 339 settings. (Refer to page 21) Refer to the inverter manual (applied) for details of Pr. 180 to Pr.189.

## 6.5.2 Inverter output signal (network output SNVT\_state nvolnvOutputSig)

A 16-bit-wide output signal to the inverter.

- Data send timing ..... As set in *Pr. 388 Heartbeat send time interval* and *Pr. 389 Minimum heartbeat send time*. (Refer to page 84)

Bit	Signal Name	Description
0	During forward running	OFF :Other than during forward running (during stop, during reverse running) ON :During forward running
1	During reverse running	OFF :Other than during reverse running (during stop, during forward running) ON :During reverse running
2	During running (terminal RUN function) *1	Functions assigned to terminals RUN, SU, OL, IPF, FU, ABC1 and ABC2 are activated.
3	Up to frequency (terminal SU function) *1	
4	Overload alarm (terminal OL function) *1	
5	Instantaneous power failure (terminal IPF function) *1	
6	Frequency detection (terminal FU function) *1	
7	Alarm (terminal ABC1 function) *1	
8	— (terminal ABC2 function) *1	
9 to 13	Not used	System reserved
14	Error status flag	Turns ON when the output has stopped due to occurrence of an inverter alarm. *2
15	Ready signal	Turns ON when the inverter is placed in the READY status at completion of initial setting after a hardware reset made after power-on. Turns off when the inverter alarm occurs (when the protective function is activated).

\*1 Signal names are initial values. Using *Pr. 190* to *Pr. 196*, you can change output signal functions. Refer to *the inverter manual (applied)* for details of *Pr. 190* to *Pr.196*.

\*2 When the retry function is used, the signal turns on according to the retry setting. Refer to the inverter manual for the retry function.





### 6.5.3 Set frequency write destination selection (network input SNVT\_switch nvilnvSetFreqSw)

When writing the set frequency of any of the following network variable, you can select either of the internal memories of the inverter, RAM and EEPROM, as the write destination.

Network Variables Supported	
Set frequency (0.1Hz increments) (nvilnvSetFreq)	Refer to page 51
Set frequency (0.005%increments) (nvilnvSetFreqP)	Refer to page 51
Set frequency (0.01Hzincrements) (nvilnvSetFreq2)	Refer to page 73

State	Value	Write Destination	Operation
H0 (initial value)	Don't care (not used/initial value: 0)	RAM	Switching power off erases the written value. You can prevent the write life of the EEPROM from becoming shorter.
H1		RAM, EEPROM	Switching power off does not erase the written value.
H2 to HFF		—	Invalid

· Data acceptance timing ..... At network variable receive (nv\_update\_occurs event)

---

**CAUTION**

---

**When changing the set frequency frequently, set "RAM write."**

**With "write to EEPROM" being selected, frequent setting of the set frequency will shorten the life of the EEPROM.**

---

### 6.5.4 Set frequency (0.1Hz increments) (network input SNVT\_freq\_hz nvilnvSetFreq)

The set frequency can be set in 0.1Hz increments.

Data Name	Initial Value	Range	Increments
nvilnvSetFreq	H7FFF	0.0Hz to 400.0Hz, H7FFF	0.1Hz/bit

- Data acceptance timing ..... At network variable receive (nv\_update\_occurs event)

#### REMARKS

- When H7FFF is set, the set frequency is as set in "start/stop/simple speed setting (nviDrvSpeedStpt)". (Refer to page 45)
- H7FFF is not reflected as the actual set frequency value.

### 6.5.5 Set frequency (0.005% increments) (network input SNVT\_lev\_percent nvilnvSetFreqP)

You can monitor the output frequency of the inverter in 0.005% increments on the assumption that the frequency set in "% set reference frequency (ncilnvSetFreqBas)" is 100%. (Refer to pages 82)

Data Name	Initial Value	Range	Increments
nvilnvSetFreqP	100.000%	0.000% to 163.830%	0.005%/bit

- Data acceptance timing ..... At network variable receive (nv\_update\_occurs event)

Example:

When "% set reference frequency (ncilnvSetFreqBas)" = 60.0Hz and "set frequency (nvilnvSetFreqP)" = 50.000%, set frequency =  $60 \times 0.5 = 30\text{Hz}$

#### REMARKS

- Control can not be exercised at less than the minimum frequency resolution (0.01Hz) of the inverter.



### 6.5.6 Output frequency monitor (0.1Hz increments) (network output SNVT\_freq\_hz nvolnvOutFreq)

You can monitor the output frequency of the inverter in 0.1Hz increments.

Data Name	Initial Value	Range	Increments
nvolnvOutFreq	0.0Hz	0.0Hz to 400.0Hz	0.1Hz/bit

- Data send event ..... When data changes in 0.1Hz increments
- Data send timing ..... As set in *Pr. 388 Heartbeat send time interval* and *Pr. 389 Minimum heartbeat send time*. (Refer to page 84)

#### REMARKS

This variable is similar to "output frequency monitor (0.005% increments)" but may sometimes differ from it in data send timing since they are different in mutual resolution. (Refer to page 53)

### 6.5.7 Output frequency monitor (0.005% increments) (network output SNVT\_lev\_percent nvolnvOutFreqP)

You can monitor the output frequency of the inverter in 0.005% increments on the assumption that the frequency set in "% set reference frequency (ncilnvSetFreqBas) " is 100%. (Refer to page 82.)

Data Name	Initial Value	Range	Increments
nvolnvOutFreqP	0.000%	0.000% to 163.830%	0.005%/bit

- Data send event ..... When data changes in 0.005% increments
- Data send timing ..... As set in Pr. 388 Heartbeat send time interval and Pr. 389 Minimum heartbeat send time. (Refer to page 84.)

Example:  
 When inverter output frequency = 90.0Hz and % set reference frequency = 60.0Hz,  
 $\frac{90.0\text{Hz}}{60.0\text{Hz}} = 1.5$       Therefore, the monitoring value is 150.000%.

#### REMARKS

- Monitoring is disabled at less than the minimum frequency resolution (0.01Hz) of the inverter.
- This variable is similar to "output frequency monitor (0.1Hz increments)" but may sometimes differ from it in data send timing since they are different in mutual resolution. (Refer to page 52.)



### **6.5.8 Output current monitor (0.1A increments) (network output SNVT\_amp nvoDrvCurrnt)**

You can monitor the output current of the inverter in 0.1A increments.

Data Name	Initial Value	Range	Increments
nvoDrvCurrnt	0.0A	0.0A to 3276.7A	0.1A/bit

- Data send event ..... When data changes in 0.1A increments
- Data send timing ..... As set in *Pr. 388 Heartbeat send time interval* and *Pr. 389 Minimum heartbeat send time*. (Refer to page 84.)

### **6.5.9 Output voltage monitor (0.1V increments) (network output SNVT\_volt nvoDrvVolt)**

You can monitor the output voltage of the inverter in 0.1V increments.

Data Name	Initial Value	Range	Increments
nvoDrvVolt	0.0V	0.0V to 3276.7V	0.1V/bit

- Data send event ..... When data changes in 0.1V increments
- Data send timing ..... As set in *Pr. 388 Heartbeat send time interval* and *Pr. 389 Minimum heartbeat send time*. (Refer to page 84)

### **6.5.10 Actual operation time monitor (1h increments) (network output SNVT\_time\_hour nvoDrvRunHours)**

You can monitor the actual operation time (cumulative inverter output time) of the inverter in 1h increments.

Data Name	Initial Value	Range	Increments
nvoDrvRunHours	0h	0 to 65534h	1h/bit

- Data send event ..... When data changes in 1h increments
- Data send timing ..... As set in *Pr. 388 Heartbeat send time interval* and *Pr. 389 Minimum heartbeat send time*. (Refer to page 84)

### 6.5.11 Cumulative power monitor (1kWh increments) (network output SNVT\_elec\_kwh nvoDrvRunPower)

You can monitor the cumulative power of the inverter in 1kWh increments.

You can select monitoring data from either BCD code data or binary data according to *Pr. 170 Watt-hour meter clear*. The initial value is binary data. (*For details of Pr. 170, refer to the inverter manual.*)

Data Name	Initial Value	<i>Pr. 170</i>	Range	Increments
		10	0 to 9999kWh (BCD code data)	
nvoDrvRunPower	0kWh	9999 (initial value)	0 to 65535kWh (binary data)	1kWh/bit *1

\*1 The digit of monitoring data shifts according to the *Pr. 891* setting. Refer to *the inverter manual (applied)* for details of *Pr. 891*.

#### REMARKS

When the numerical value exceeds the maximum value in the monitoring range, the value returns to 0 and is recounted from 0.

- Data send event ..... When data changes in 1kWh increments.
- Data send timing ..... As set in *Pr. 388 Heartbeat send time interval* and *Pr. 389 Minimum heartbeat send time*. (*Refer to page 84*)



### 6.5.12 Cumulative power monitor 2 (0.1kWh increments) (network output SNVT\_elec\_kwh\_I nvoDrvRunPower\_I)

You can monitor cumulative power of the inverter in 32 bit data and 0.1kWh increments.

Data Name	Initial Value	Inverter Capacity		Range	Increments
		55K or less	75K or more		
NvoDrvRunPower_I	0kWh	55K or less		0 to 42949672.9kWh	0.1kWh/bit
			75K or more	0 to 214748364.6kWh	

Cumulative power monitor 2 is available with the FR-A700/FP700 series and FR-F700 series inverter assembled in and after September 2004 (55K or less) and in and after August 2004 (75K or more). (Refer to page 4)  
(The inverter type, 55K and 75K differ according to -NA and -EC versions. Refer to page 1.)

#### REMARKS

If the value exceeds the maximum value of the monitor range, the value returns to 0 and is recounted from 0.

- Data send event ..... at data change in 0.1kWh increments
- Data send timing ..... depends on the settings of Pr. 388 heartbeat send time interval and Pr. 389 minimum heartbeat send time. (Refer to page 84)

### 6.5.13 Alarm reset (network input SNVT\_switch nvilnvAlarmReset)

You can reset the inverter at inverter alarm occurrence.

Data Name	Initial Value	Range		Operation
		state	value	
nvilnvAlarmReset	H0	H0	Don't care (not used)	Without alarm reset
		H1		Execute an alarm reset.
		H2 to HFF		Invalid

- Data acceptance timing..... When network variables are being received and state = 1 (nv\_update\_occurs event)
- Setting "1" in Pr.349 disables the alarm reset command in operations other than network operation.

#### REMARKS

You can reset the inverter at inverter alarm occurrence. When the inverter is not during an alarm, performing this operation does not reset the inverter.

### 6.5.14 Alarm occurrence definition (network output SNVT\_str\_asc nvolnvAlarmStr)

At inverter alarm occurrence, you can confirm the alarm definition of the inverter with a character string.

- If an inverter alarm occurs at power-on/inverter reset, data is not sent before the *Pr.387 Initial communication delay time* (nciPwUpOutTm) (Refer to page 80).
- The initial setting of +0 to +30 is 0.
- Data send timing ..... At inverter alarm occurrence

Storage position	Definition (ASCII code)
+0	(Alarm code)H
+1	E (H45)
+2	. (H2E)
+3	Character 1 (Character 1)
+4	Character 2 (Character 2)
+5	Character 3 (Character 3)
+6 to +30	(H00)L

#### Alarm Code Correspondence Table

Definition	+0	+1	+2	+3	+4	+5	+6 to +30
	Alarm Code	E	.	Character 1	Character 2	Character 3	
OC1	H10	E(H45)	.(H2E)	O(H4F)	C(H43)	1(H31)	
OC2	H11			O(H4F)	C(H43)	2(H32)	
OC3	H12			O(H4F)	C(H43)	3(H33)	
OV1	H20			O(H4F)	V(H56)	1(H31)	
OV2	H21			O(H4F)	V(H56)	2(H32)	
OV3	H22			O(H4F)	V(H56)	3(H33)	
THT	H30			T(H54)	H(H48)	T(H54)	
THM	H31			T(H54)	H(H48)	M(H4D)	
FIN	H40			F(H46)	I(H49)	N(H4E)	
IPF	H50			I(H49)	P(H50)	F(H46)	
UVT	H51			U(H55)	V(H56)	T(H54)	
ILF	H52			I(H49)	L(H4C)	F(H46)	
OLT	H60			O(H4F)	L(H4C)	T(H54)	
SOT *5	H61			S(H53)	O(HF4)	T(H54)	





Definition	+0	+1	+2	+3	+4	+5	+6 to +30
	Alarm Code	E	.	Character 1	Character 2	Character 3	
BE	H70	E(H45)	.(H2E)	B(H42)	E(H45)	Space(H20)	
GF	H80			G(H47)	F(H46)	Space(H20)	
LF	H81			L(H4C)	F(H46)	Space(H20)	
OHT	H90			O(H4F)	H(H48)	T(H54)	
PTC	H91			P(H50)	T(H54)	C(H43)	
OPT	HA0			O(H4F)	P(H50)	T(H54)	
OP1	HA1			O(H4F)	P(H50)	1(H31)	
OP3 *2	HA3			O(H4F)	P(H50)	3(H33)	
PE	HB0			P(H50)	E(H45)	Space(H20)	
PUE	HB1			P(H50)	U(H55)	E(H45)	
RET	HB2			R(H52)	E(H45)	T(H54)	
PE2	HB3			P(H50)	E(H45)	2(H32)	
CPU	HC0			C(H43)	P(H50)	U(H55)	
CTE	HC1			C(H43)	T(H54)	E(H45)	
P24	HC2			P(H50)	2(H32)	4(H34)	
CDO	HC4			C(H43)	D(H44)	O(H4F)	
IOH	HC5			I(H49)	O(H4F)	H(H48)	
SER	HC6			S(H53)	E(H45)	R(H52)	
AIE	HC7			A(H41)	I(H49)	E(H45)	
USB *2, *3	HC8			A(H41)	L(H4C)	Space(H20)	
OS *2, *4	HD0			O(H4F)	S(H53)	Space(H20)	
OSD *2, *4	HD1			O(H4F)	S(H53)	D(H44)	
ECT *2, *4	HD2			E(H45)	C(H43)	T(H54)	
OD *2, *4	HD3			O(H4F)	D(H44)	Space(H20)	
MB1 *2	HD5			M(H4D)	B(H42)	1(H31)	

Definition	+0	+1	+2	+3	+4	+5	+6 to +30
	Alarm Code	E	.	Character 1	Character 2	Character 3	
MB2 *2	HD6	E(H45)	.(H2E)	M(H4D)	B(H42)	2(H32)	
MB3 *2	HD7			M(H4D)	B(H42)	3(H33)	
MB4 *2	HD8			M(H4D)	B(H42)	4(H34)	
MB5 *2	HD9			M(H4D)	B(H42)	5(H35)	
MB6 *2	HDA			M(H4D)	B(H42)	6(H36)	
MB7 *2	HDB			M(H4D)	B(H42)	7(H37)	
EP *2, *4	HDC			E(H45)	P(H50)	Space(H20)	
E1	HF1			E(H45)	1(H31)	Space(H20)	
E2 *2	HF2			E(H45)	2(H32)	Space(H20)	
E3 *2	HF3			E(H45)	3(H33)	Space(H20)	
E6	HF6			E(H45)	6(H36)	Space(H20)	
E7	HF7			E(H45)	7(H37)	Space(H20)	
E11 *2	HFB			E(H45)	1(H31)	1(H31)	
E13	HFD			E(H45)	1(H31)	3(H33)	

- \*1 Value in parenthesis is ASCII code.
- \*2 Displayed only for the FR-A700 series.
- \*3 Although "E.AL" is sent in ASCII code character string, the alarm definition is "E.USB".
- \*4 Available only when the FR-A7AP is mounted.
- \*5 Displayed only for the FR-FP700 series.



### 6.5.15 Product information (maker name, type) (network output SNVT\_str\_asc nvolnvTypeInfo)

When an alarm has occurred in the inverter, you can send the "maker name (MITSUBISHI)" and "type (FR-A7NL)" data as a character string (ASCII).

At power-on/inverter reset, data is not sent before the *Pr.387 Initial communication delay time* (nciPwUpOutTm) (Refer to page 80).

- Data send timing ..... At power-on/inverter reset/inverter alarm occurrence

Storage position	Data (ASCII code)	
+0	M	H
+1	I	
+2	T	
+3	S	
+4	U	
+5	B	
+6	I	
+7	S	
+8	H	
+9	I	
+10	(20H)	L
+11	F	
+12	R	
+13	-	
+14	A	
+15	7	
+16	N	
+17	L	
+18 to +30	(00H)	

### 6.5.16 Emergency stop command (network input SNVT\_hvac\_emerg nviEmergOverride)

You can give an emergency stop command during inverter operation.

If "EMERG\_SHUTDOWN" is requested during inverter operation, the inverter decelerates to a stop independently of the operation mode.

Data Name	Initial Value	Range	Description
nviEmergOverride	H0	H0	EMERG_NORMAL Emergency stop cancel
		H4	EMERG_SHUTDOWN Emergency stop
		HFF	EMERG_NUL Invalid (no operation)

- Data acceptance timing ..... At network variable receive (nv\_update\_occurs event)

(1) Emergency Stop	(2) Emergency Stop Cancel
<ul style="list-style-type: none"> <li>· The deceleration time depends on the Pr. 8, Pr. 44 and other settings.</li> <li>· When the inverter starts decelerating under the emergency stop command, " P5 " appears in the display section of the operation panel (FR-DU07) and the inverter is put in an emergency stop status.</li> <li>· An emergency stop status cannot be canceled unless emergency stop cancel operation is performed.</li> <li>· During occurrence of a communication line error, an emergency stop command is not accepted.</li> <li>· During an inverter stop, an emergency stop command is invalid.</li> </ul>	<ul style="list-style-type: none"> <li>· During an inverter stop, turn OFF all start commands (forward rotation command, reverse rotation command) and request "EMERG_NORMAL". When the inverter recognizes this status, it cancels the emergency stop and also " P5 " shown in the display section disappears.</li> <li>· During deceleration made under an emergency stop command, performing emergency stop cancel operation will not cancel an emergency stop immediately. Perform emergency stop cancel operation during an inverter stop.</li> </ul>



### 6.5.17 Emergency stop status (network output SNVT\_hvac\_emerg nvoEmergStatus)

You can indicate the emergency stop status of the inverter.

Data Name	Initial Value	Range	Description
nvoEmergStatus	H0	H0	EMERG_NORMAL During normal or emergency stop cancel
		H4	EMERG_SHUTDOWN During emergency stop

- Data send event ..... When the value data changes at emergency stop command receive
- Data send timing ..... As set in Pr. 388 Heartbeat send time interval and Pr. 389 Minimum heartbeat send time. (Refer to page 84.)

#### Emergency Stop Operation Timing Chart

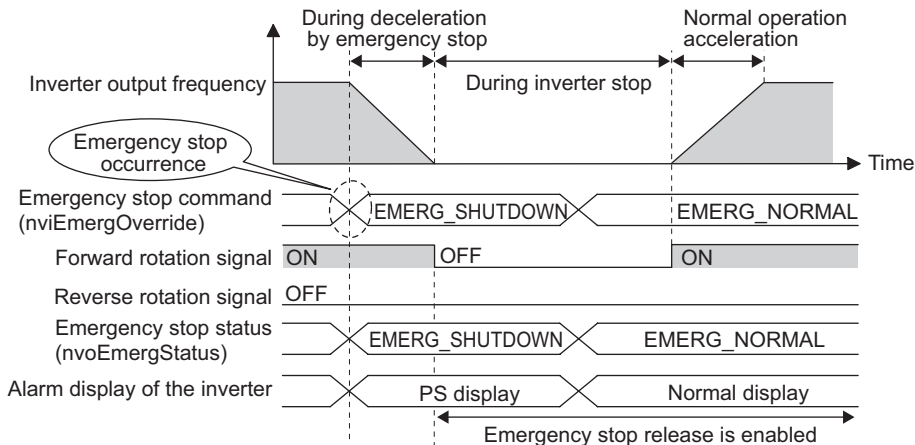

### 6.5.18 Alarm status (network output SNVT\_switch nvoDrvAlarm)

You can indicate the alarm status of the inverter.

Data Name	Range		Operation
	state	value	
nvoDrvAlarm	H0 (initial value)	Don't care (not used)	Inverter normal
	H1	(initial value: 0)	During inverter alarm

- Data send timing ..... As set in *Pr. 388 Heartbeat send time interval* and *Pr. 389 Minimum heartbeat send time*. (Refer to page 84.)



## 6.6 Inverter PID Control Functions

### System configuration example

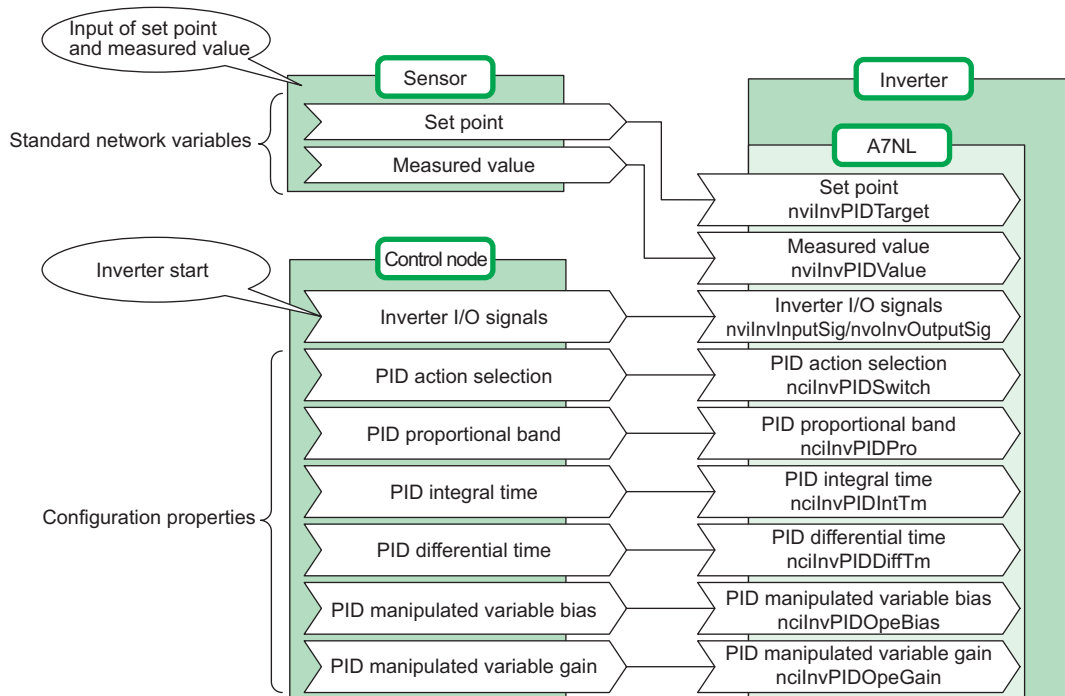

### 6.6.1 PID set point (network input SNVT\_lev\_percent nvilnvPIDTarget)

Enter the target value of air volume, temperature, etc. in 0.005% increments.

Data Name	Initial Value	Range	Increments
nvilnvPIDTarget	0.000%	0.00% to 100.00%	0.005%/bit

- Data acceptance timing .....At network variable receive (nv\_update\_occurs event)

Example:

When setting 30°C as the set point using a 10°C/0% and 50°C/100% detector,

$$\frac{(30 - 10)}{(50 - 10)} \times 100 = 50\%. \text{ As the PID set point, input } 50.00\%.$$

#### REMARKS

- Control can not be exercised at less than the minimum resolution (0.01%) of the inverter.
- When the value outside of the range is input, the input value is made invalid and the inverter operates with the value set last time.





### 6.6.2 PID measured value (network input SNVT\_lev\_percent nvInvPIDValue)

Enter the measured value of air volume, temperature, etc. in 0.005% increments.

Data Name	Initial Value	Range	Increments
nvInvPIDValue	0.000%	0.00% to 100.00%	0.005%/bit

- Data acceptance timing .....At network variable receive (nv\_update\_occurs event)

Example:

When the measured value is 25°C on a 10°C/0% and 50°C/100% detector,

$$\frac{(25 - 10)}{(50 - 10)} \times 100 = 37.5\%. \text{ As the PID measured value, input 37.50\%.}$$

#### REMARKS

- Control cannot be exercised at less than the minimum resolution (0.01%) of the inverter.
- When the value outside of the range is input, the input value is made invalid and the inverter operates with the value set last time.

### 6.6.3 PID deviation (network input SNVT\_lev\_percent nvInvPIDDev)

Input the set value of air volume, temperature, etc. in 0.005% increments.

Data Name	Initial Value	Range	Increments
nvInvPIDDev	0.000%	-100.00% to +100.00%	0.005%/bit

- Data acceptance timing ..... At network variable receive (nv\_update\_occurs event)

Example:

When the set point is 25°C and the current temperature is 30°C on a 10°C/0% and 50°C/100% detector (deviation: +5°C),

$$\frac{(30 - 25)}{(50 - 10)} \times 100 = 12.5\%. \quad \text{As the PID deviation, input 12.50\%.$$

#### REMARKS

- Control cannot be exercised at less than the minimum resolution (0.01%) of the inverter.
- When the value outside of the range is input, the input value is made invalid and the inverter operates with the value set last time.



## 6.7 Inverter Extended Functions

### 6.7.1 Monitor code (network input SNVT\_count nvInvMonCode)

Set the monitor data you want to monitor.

The monitor value enters "monitor data (nvInvMonData)". (Refer to page 72)

Data Name	Initial Value	Range	Increments
nvInvMonCode	H0	H0 to H003C	—

· Data acceptance timing ..... At network variable receive (nv\_update\_occurs event)

#### <Monitor Code Table>

Code	Description	Increments	100% Value of Event Driven Detection Width (Refer to page 99)
H0000	No monitoring *1	—	—
H0001	Output frequency	0.01Hz	Pr. 55 Frequency monitoring reference setting
H0002	Output current	0.01A/0.1A *2	Pr. 56 Current monitoring reference setting
H0003	Output voltage	0.1V	200V class: 400V, 400V class: 800V
H0004	No monitoring *1	—	—
H0005	Frequency setting	0.01Hz	Pr. 55 Frequency monitoring reference setting
H0006	Running speed	1r/min	1000r/min
H0007	Motor torque *3	0.1%	Pr.866 Torque monitoring reference setting
H0008	Converter output voltage	0.1V	200V class: 400V, 400V class: 800V
H0009	Regenerative brake duty	0.1%	Pr.70 Special regenerative brake duty setting
H000A	Electronic thermal relay function load factor	0.1%	100%
H000B	Output current peak value	0.01A/0.1A *2	Pr. 56 Current monitoring reference
H000C	Converter output voltage peak value	0.1V	200V class: 400V, 400V class: 800V
H000D	Input power	0.01kW/0.1kW *2	Rated inverter power × 2
H000E	Output power	0.01kW/0.1kW *2	Rated inverter power × 2
H000F	Input terminal status *5	—	—

Code	Description	Increments	100% Value of Event Driven Detection Width (Refer to page 99)
H0010	Output terminal status *6	—	—
H0011	Load meter	0.1%	100% (Pr. 56 Current monitoring reference setting)
H0012	Motor excitation current *3	0.01A/0.1A *2	Pr. 56 Current monitoring reference
H0013	Position pulse *3, *4	—	—
H0014	Cumulative energization time	1h	—
H0015	No monitoring *1	—	—
H0016	Orientation status *3, *4	—	—
H0017	Actual operation time	1h	—
H0018	Motor load factor	0.1%	200% (rated inverter current × 2)
H0019	Cumulative power	1kWh	—
H0020	Torque command *3	0.1%	Pr.866 Torque monitoring reference setting
H0021	Torque current command *3	0.1%	Pr.866 Torque monitoring reference setting
H0022	Motor output *3	0.01kW/0.1kW *2	Rated motor capacity
H0023	Feedback pulse *3, *4	—	—
H0032	Power saving effect	—	The monitor description differs according to the Pr. 895, Pr. 896 and Pr. 897 settings. *10
H0033	Power saving effect cumulative value	—	The monitor description differs according to the Pr. 896 and Pr. 899 settings. *11
H0034	PID set point	0.1%	100%
H0035	PID measured value	0.1%	100%
H0036	PID deviation	0.1%	100%
H003A	Option input terminal monitor 1 *3, *7	—	—
H003B	Option input terminal monitor 2 *3, *8	—	—
H003C	Option output terminal monitor *3, *9	—	—

When a monitor code other than the above is set, monitor data (nvInvMonData) becomes arbitrary value.



- \*1 The value of the first monitor is "0", and the value is the value previously monitored when switched from other monitor.
- \*2 The setting depends on the inverter capacity. (55K or less / 75K or more)  
(The inverter type, 55K and 75K differ according to -NA and -EC versions. *Refer to page 1.*)
- \*3 These items can be monitored with the FR-A700 series only.
- \*4 Monitoring is enabled only when the FR-A7AP is mounted.
- \*5 Input terminal monitor details

b15 b0

—	—	—	—	CS	RES	STOP	MRS	JOG	RH	RM	RL	RT	AU	STR	STF
---	---	---	---	----	-----	------	-----	-----	----	----	----	----	----	-----	-----

- \*6 Output terminal monitor details

b15 b0

—	—	—	—	—	—	—	—	—	—	ABC2	ABC1	FU	OL	IPF	SU	RUN
---	---	---	---	---	---	---	---	---	---	------	------	----	----	-----	----	-----

- \*7 Details of option input terminal monitor 1 (input terminal status of FR-A7AX)

—all terminals are off when an option is not fitted.

b15 b0

X15	X14	X13	X12	X11	X10	X9	X8	X7	X6	X5	X4	X3	X2	X1	X0
-----	-----	-----	-----	-----	-----	----	----	----	----	----	----	----	----	----	----

- \*8 Details of option input terminal monitor 2 (input terminal status of FR-A7AX)

—all terminals are off when an option is not fitted.

b15 b0

—	—	—	—	—	—	—	—	—	—	—	—	—	—	—	—	DY
---	---	---	---	---	---	---	---	---	---	---	---	---	---	---	---	----

- \*9 Details of option output terminal monitor (output terminal status of FR-A7AY/A7AR)

—all terminals are off when an option is not fitted.

b15 b0

—	—	—	—	—	—	RA3	RA2	RA1	Y6	Y5	Y4	Y3	Y2	Y1	Y0
---	---	---	---	---	---	-----	-----	-----	----	----	----	----	----	----	----

- \*10 The monitor description differs according to the *Pr. 895* to *Pr. 897* settings.  
(Refer to the inverter manual (applied) for details of *Pr. 895* to *Pr. 897*.)

Monitor Description		Increments		100% Value
		55K or less	75K or more	
1)	Power savings	0.01kW	0.1kW	Rated inverter power
2)	Power saving rate	0.1%		100%
3)	Energy saving average value	0.01kW	0.1kW	Rated inverter power
4)	Power saving rate average value	0.1%		100%
5)	Power saving amount average value	0.01		Rated inverter power $\times \frac{Pr. 896}{100}$ (Note that the value higher than 65535 is 65535.)

(The inverter type, 55K and 75K differ according to -NA and -EC versions. Refer to page 1.)

- \*11 The monitor description differs according to the *Pr. 896* and *Pr. 899* settings.  
(Refer to the inverter manual (applied) for details of *Pr. 896* and *Pr. 899*.)

	Monitor Item	Increments	100% Value
6)	Power saving amount	1kWh	100
7)	Power saving amount charge	1	(The 100% of monitor data value is 100 to the value after digit shifted by <i>Pr. 891</i> . For example, when <i>Pr. 891</i> = 2, the 100% value is 10000 (kWh) as two digits shift occurs.)
8)	Annual power saving amount	1kWh	
9)	Annual power saving amount charge	1	



### 6.7.2 Monitor data (network output *SNVT\_count nvInvMonData*)

You can monitor the monitor description set in "monitor code (nvInvMonCode)". (Refer to page 68)

Data Name	Initial Value	Range	Increments
nvInvMonData	0	0 to 65535	Refer to the monitor code table. (Page 68)

- Data send event ..... When the monitor value data changes
- Data send timing ..... As set in *Pr. 388 Heartbeat send time interval* and *Pr. 389 Minimum heartbeat send time*. (Refer to page 84.)

Example:  
If the monitor value is 60.00Hz, "6000" is displayed.

### 6.7.3 Set frequency (0.01Hz increments) (network input SNVT\_count nvInvSetFreq2)

You can set the set frequency in 0.01Hz increments.

Data Name	Initial Value	Range	Increments
nvInvSetFreq2	0.00Hz	0.00Hz to 400.00Hz	0.01Hz/bit

- Data acceptance timing ..... At network variable receive (nv\_update\_occurs event)

Example:

If you want to set 120.00Hz, set "12000", the value 100 times greater than the desired frequency.

### 6.7.4 Output frequency monitor (0.01Hz increments) (network output SNVT\_count nvInvOutFreq2)

You can monitor the output frequency of the inverter in 0.01Hz increments.

Data Name	Initial Value	Range	Increments
nvInvOutFreq2	0.00Hz	0.00Hz to 400.00Hz	0.01Hz/bit

- Data send event ..... When the data changes in 0.01Hz increments
- Data send timing ..... As set in *Pr. 388 Heartbeat send time interval* and *Pr. 389 Minimum heartbeat send time*. (Refer to page 84.)

Example:

If the monitor value is 120.00Hz, "12000", the value 100 times greater, is displayed.





### 6.7.5 Command request (network input SNVT\_str\_asc nvInvCmdReq)

You can set the instruction code and written data for executing operation mode rewrite, parameter read and write, alarm history reference, parameter clear, etc.

The format is as shown below. The data to be set are in ASCII code. The initial setting of +0 to +30 is 0.

Request flag	01	Command request is made
	Other than 01	Command request is not made
Request code	Refer to the command list on the next page to set the instruction code.	
Request data	Set the data at writing. (Set H0000 at reading.)	

- Data acceptance timing.....At network variable receive (nv\_update\_occurs event) and when request flag = 1

Storage position	Data (ASCII code)	
+0	Request flag	H L
+2	Request code	H
		L
+6	Request data	H
		L
+10 to +30	0	

#### Setting example

1. When writing "Pr: 7

Acceleration time = 10.0s"

Storage position	Data (ASCII code)	
+0	0 (H30)	H
	1 (H31)	L
+2	0 (H30)	H
	0 (H30)	
	8 (H38)	
	7 (H37)	L
+6	0 (H30)	H
	0 (H30)	
	6 (H36)	
	4 (H34)	L
+10 to +30	0	

2. When resetting the inverter

Storage position	Data (ASCII code)	
+0	0 (H30)	H
	1 (H31)	L
+2	0 (H30)	H
	0 (H30)	
	F (H46)	
	D (H44)	L
+6	9 (H39)	H
	6 (H36)	
	9 (H39)	
	6 (H36)	L
+10 to +30	0	

## Command List

Item	Read/Write	Instruction Code	Data Description																				
Operation mode	Read	H007B	H0000: Network operation H0001: External operation H0002: PU operation																				
	Write	H00FB	H0000: Network operation H0001: External operation H0002: PU operation (When <i>Pr. 79</i> = "6")																				
Alarm definition	Read	H0074 to H0077	<p>H0000 to HFFFF: Last two alarm definitions</p> <p>Refer to the alarm code correspondence table (<i>page 57</i>).</p> <table border="1" style="margin-left: 20px;"> <tr> <td></td> <td style="text-align: center;">b15</td> <td style="text-align: center;">b8 b7</td> <td style="text-align: center;">b0</td> </tr> <tr> <td>H74</td> <td>Second alarm in past</td> <td>Latest alarm</td> <td></td> </tr> <tr> <td>H75</td> <td>Fourth alarm in past</td> <td>Third alarm in past</td> <td></td> </tr> <tr> <td>H76</td> <td>Sixth alarm in past</td> <td>Fifth alarm in past</td> <td></td> </tr> <tr> <td>H77</td> <td>Eighth alarm in past</td> <td>Seventh alarm in past</td> <td></td> </tr> </table>		b15	b8 b7	b0	H74	Second alarm in past	Latest alarm		H75	Fourth alarm in past	Third alarm in past		H76	Sixth alarm in past	Fifth alarm in past		H77	Eighth alarm in past	Seventh alarm in past	
	b15	b8 b7	b0																				
H74	Second alarm in past	Latest alarm																					
H75	Fourth alarm in past	Third alarm in past																					
H76	Sixth alarm in past	Fifth alarm in past																					
H77	Eighth alarm in past	Seventh alarm in past																					
Set frequency (RAM)	Read	H006D	Read set frequency/speed from RAM or EEPROM.																				
Set frequency (EEPROM)		H006E	· H0000 to HFFFF: Set frequency.... Increments 0.01Hz (Even when speed display is set using <i>Pr. 37</i> and <i>Pr. 144</i> , the value is displayed in 0.01Hz increments.)																				



Item	Read/Write	Instruction Code	Data Description
Set frequency (RAM)	Write	H00ED	Write set frequency/speed to RAM or EEPROM. · H0000 to H9C40 (0 to 400.00Hz): Frequency .... Increments 0.01Hz
Set frequency write (RAM and EEPROM)	Write	H00EE	(Even when speed display is set using <i>Pr. 37</i> and <i>Pr. 144</i> , the value is displayed in 0.01Hz increments.) · To change the set frequency consecutively, write data to the inverter RAM. (Code number: HED)
Parameter	Read	H0000 to H0063	· Refer to the instruction code in the inverter manual (applied) to read and write as required. Write to <i>Pr. 77</i> and <i>Pr. 79</i> is disabled. When setting <i>Pr. 100</i> and later, link parameter expansion setting must be set.
	Write	H0080 to H00E3	· Set 65520 (HFFF0) as a parameter value "8888" and 65535 (HFFFF) as "9999". · When changing the parameter values frequently, set "1" in <i>Pr. 342</i> to write them to the RAM. ( <i>Refer to page 24.</i> )
Alarm definition all clear	Write	H00F4	H9696: Batch-clears the alarm description

Item	Read/Write	Instruction Code	Data Description				
All parameter clear	Write	H00FC	All parameters return to the initial values. Any of four different all clear operations are performed according to the data. All clear types (O...Clear, x...not clear)				
			<b>Data</b>	<b>Communication Parameters</b>	<b>Calibration Parameters</b>	<b>Other Parameters</b>	<b>HEC, HF3, HFF</b>
			H9696	○ *1	×	○	○
			H9966	○ *1	○	○	○
			H5A5A	×	×	○	○
			H55AA	×	○	○	○
Inverter reset	Write	H00FD	H9696: Reset the inverter.				
Link parameter expansion setting	Read	H007F	Parameter description is changed according to the H00 to H09 setting. Refer to the instruction code of the inverter instruction manual (applied) for details of the values.				
	Write	H00FF					
Second parameter changing *2	Read	H006C	When setting the bias / gain (C2 to C7, C12 to C19, C38 to C41 *3) parameters H00: Frequency *4				
	Write	H00EC	H01: Analog value set in parameters H02: Analog value input from the terminal				

\*1 Communication parameters (Pr. 117 to Pr. 124, Pr. 331 to Pr.341, Pr.343, Pr.549 to Pr.551) are also cleared.

\*2 Setting can be made when the link parameter expansion setting = "1, 9".

\*3 C12 to C19, C38 to C41 are available with the FR-A700 series only. Refer to the parameter list of the inverter for instruction code.

\*4 Gain frequencies can be written using Pr. 125 (instruction code H99) and Pr. 126 (instruction code H9A) also.



Command processing is performed in the following procedure.

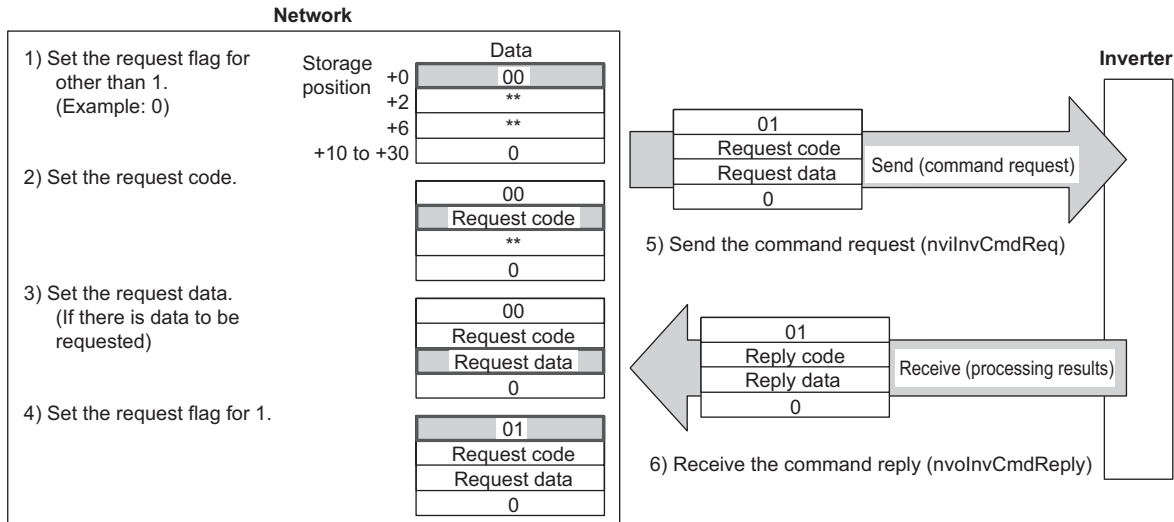

### 6.7.6 Command reply (network output *SNVT\_str\_asc nvlnvCmdReply*)

Gives a reply to the command requested in "command request (nvlnvCmdReq) (Refer to page 74)". The data entered are the reply code and read data as the command processing results. The format is as shown below. The data to be set are in ASCII code. The initial setting of +0 to +30 is 0.

Reply flag	H01	Reply to command request
Reply code (Results in response to the command request enter)	H0000	Normal completion of command
	Other than H0000	Command execution error
		H0001: Mode error (different operation mode)
H0002: Instruction code error (specified instruction code does not exist)		
		H0003: Data range error (data written is outside the range)
Reply data	The data is set at reading. (A given value is set at writing.)	

· Data send event..... At command processing completion

Data (ASCII code)	
Storage position +0	Request flag
	L
+2	Reply code
	L
+6	Reply data
	L
+10 to +30	0

#### Setting example

- When Pr. 8 Deceleration time with "5.0s" set in is read
- When the latest alarm (OPT) and second alarm in past (OC1) are read

Data (ASCII code)		Data (ASCII code)	
+0	0 (H30)	+0	0 (H30)
	L		L
+2	1 (H31)	+2	1 (H31)
	H		H
	0 (H30)		0 (H30)
	L		L
	0 (H30)		0 (H30)
	H		H
+6	0 (H30)	+6	1 (H31)
	L		L
	0 (H30)		0 (H30)
	H		A (H41)
	3 (H33)		L
	L		0 (H30)
	2 (H32)	+10 to +30	0
	H		L
+10 to +30	0		

Refer to page 78 for the command processing procedure.



## 6.8 Configuration Properties

### 6.8.1 Initial communication delay time (network input config SNVT\_time\_sec nciPwUpOutTm)

You can set the time from when the inverter starts until when data is sent to LONWORKS at power-on or inverter reset.

#### REMARKS

- The parameter setting is made valid at power-on or inverter reset.
- The delay time at power-on and inverter reset is set and this setting does not affect normal data transmission.

Data Name		Initial Value	Range	Increments
nciPwUpOutTm		0s	0.0s to 120.0s	0.1s/bit
Parameter	Name			
387	Initial communication delay time			

- Data acceptance timing ..... At network variable receive (nv\_update\_occurs event)

## 6.8.2 Forward/reverse rotation prevention (network input config SNVT\_count nciInvFwdRevLock)

You can limit the rotation direction of the inverter. (Used to disable rotation in the wrong direction in a system where an air conditioning fan, etc. is fixed in rotation direction.)

Data Name	Initial Value	Range		Operation	Setting Value Storage Location
		state	value		
nciInvFwdRevLock	Initial value of Pr. 78	H0	Not used	Both forward rotation and reverse rotation enabled	Pr.78
		H1		Reverse rotation disabled	
		H2		Forward rotation disabled	

· Data acceptance timing .....At network variable receive (nv\_update\_occurs event)

### REMARKS

Refer to *the inverter manual (applied)* for details of Pr. 78.





### 6.8.3 % set reference frequency (network input config SNVT\_freq\_hz nciInvSetFreqBas)

You can set the reference frequency of "set frequency (nvilnvSetFreqP) (Refer to page 51)" and "output frequency monitor (nvlnvOutFreqP) (Refer to page 53)".

The % set reference frequency can not be set at less than the minimum frequency resolution of the inverter.

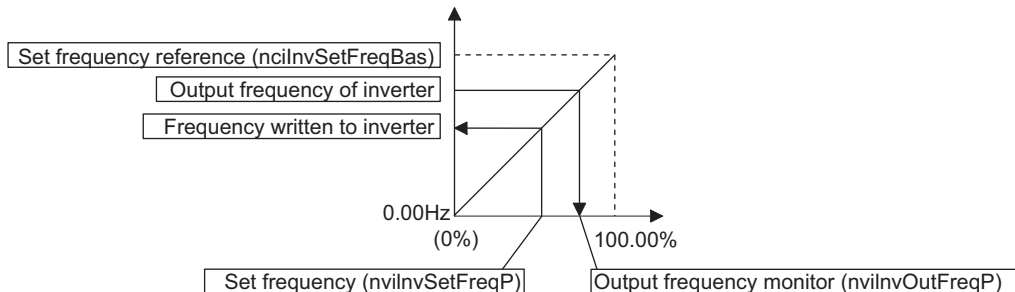

Data Name		Initial Value	Range	Increments
ncilnvSetFreqBas		60Hz / 50Hz *	1.0Hz to 400.0Hz	0.1Hz/bit
Parameter	Name		1.00Hz to 400.00Hz	0.01Hz
390	% set reference frequency			

\* 60Hz for the Japanese and NA version and 50Hz for the EC and CH version.

· Data acceptance timing ..... At network variable receive (nv\_update\_occurs event)

### 6.8.4 Maximum frequency (0.1Hz increments) (network input config SNVT\_freq\_hz ncilnvMaxFreq)

You can set the maximum frequency to be output by the motor to the inverter in 0.1Hz increments.

Data Name	Initial Value	Range	Increments	Setting Value Storage Location
ncilnvMaxFreq	Initial value of Pr. 1	0.0Hz to 400.0Hz	0.1Hz/bit	Pr.1/Pr.18

· Data acceptance timing ..... At network variable receive (nv\_update\_occurs event))

#### REMARKS

Refer to *the inverter manual (applied)* for details of Pr. 1 to Pr.18.

### 6.8.5 Minimum frequency (0.1Hz increments) (network input config SNVT\_freq\_hz ncilnvMinFreq)

You can set the minimum frequency to be output by the motor to the inverter in 0.1Hz increments.

Data Name	Initial Value	Range	Increments	Setting Value Storage Location
ncilnvMinFreq	Initial value of Pr.2	0.0Hz to 120.0Hz	0.1Hz/bit	Pr.2

· Data acceptance timing ..... At network variable receive (nv\_update\_occurs event)

#### REMARKS

Refer to *the inverter manual (applied)* for details of Pr. 2.



### **6.8.6 Heartbeat send time interval (network input config *SNVT\_time\_sec nciSndHrtBt*)**

You can set the time interval at which data is sent to network in output network variable send.

Data Name		Initial Value	Range	Increments
nciSndHrtBt		0s	0.0s to 999.8s	0.1s/bit
Parameter	Name			
388	Heartbeat send time interval			

- Data acceptance timing ..... At network variable receive (nv\_update\_occurs event)

### **6.8.7 Minimum heartbeat send time (network input config *SNVT\_time\_sec nciMinOutTm*)**

You can set the minimum time at which data is sent to network in output network variable send.

Data Name		Initial Value	Range	Increments
nciMinOutTm		0.5s	0.0s to 999.8s	0.1s/bit
Parameter	Name			
389	Minimum heartbeat send time			

- Data acceptance timing ..... At network variable receive (nv\_update\_occurs event)

**●Heartbeat send time (Pr.388, Pr.389)**

<i>Pr. 388</i> Setting	<i>Pr. 389</i> Setting	Operation
0	0	Sends data when data send event occurs. * Network variables outputting data frequently (frequent changes) causes network congestion. In such cases, adjust by setting <i>Pr. 392 Event driven detection width</i> , <i>Pr. 388</i> and <i>Pr. 389</i> .
Other than 0	0	Checks presence or absence of data send event and sends data when an event occurs. Sends data after the heartbeat send time interval ( <i>Pr. 388</i> setting) has elapsed if there is no event.
0	Other than 0	Checks for presence or absence of data send event at interval of minimum heartbeat send time ( <i>Pr. 389</i> setting). Sends data if an event presents.
<i>Pr. 388 &gt; Pr. 389</i> (Other than 0)		Checks for presence or absence of data send event at an interval of minimum heartbeat send time ( <i>Pr. 389</i> setting). Sends data if an event presents. Sends data after the heartbeat send time interval ( <i>Pr. 388</i> setting) has elapsed if there is no event.
<i>Pr. 388 ≤ Pr. 389</i> (Other than 0)		Sends data at an interval of minimum heartbeat send time ( <i>Pr. 389</i> setting) independently of presence and absence of data send event.

**REMARKS**

At power-on and inverter reset, data is not sent before the *Pr. 387 Initial communication delay time (nciPwUpOutTm)*.  
(Refer to page 80)



The network variables subject to the heartbeat send time

Function	Network Variables		In/Out	Refer to Page
	Variable	Name		
Speed monitor (0.005%/bit)	SNVT_lev_percent	nvoDrvSpeed	Out	47
Inverter output signal	SNVT_state	nvoInvOutputSig	Out	49
Output frequency monitor (0.1Hz/bit)	SNVT_freq_hz	nvoInvOutFreq	Out	52
Output frequency monitor (0.005%/bit)	SNVT_lev_percent	nvoInvOutFreqP	Out	53
Output current monitor (0.1A/bit)	SNVT_amp	nvoDrvCurnt	Out	54
Output voltage monitor (0.1V/bit)	SNVT_volt	nvoDrvVolt	Out	54
Actual operation time monitor (1h/bit)	SNVT_time_hour	nvoDrvRunHours	Out	54
Cumulative power monitor (1kWh/bit)	SNVT_elec_kwh	nvoDrvRunPower	Out	55
Emergency stop status	SNVT_hvac_emerg	nvoEmergStatus	Out	62
Alarm status	SNVT_switch	nvoDrvAlarm	Out	63
Monitor data	SNVT_count	nvoInvMonData	Out	72
Output frequency monitor (0.01Hz/bit)	SNVT_count	nvoInvOutFreq2	Out	73
Cumulative power monitor 2 (0.1kWh/bit)	SNVT_elec_kwh_l	nvoDrvRunPower_l	Out	56

## REMARKS

The send time interval of one network variable is time set in *Pr. 388 (Pr. 389)* independently of the number of monitors bound by network management packages such as LonMaker.

For example, when the speed monitor and output current monitor are bound, the send time interval of the speed monitor is *Pr. 388 (Pr. 389)s* and the send time interval of the output current monitor is also *Pr. 388 (Pr. 389)s*.

In addition, the actual send time interval is 1.1s due to constraints of each data send time even when the heartbeat send time interval (*Pr. 388*) is set to 1.0s or less. (It takes 1.2s when monitor data is set.)

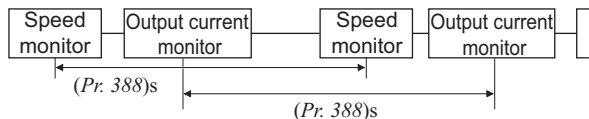

### 6.8.8 Acceleration time (network input config SNVT\_time\_sec nciRampUpTm)

You can set the time taken by the motor to accelerate from 0Hz to the set frequency (1 to 400Hz) of *Pr. 20 Acceleration/deceleration reference frequency*. (Refer to *the inverter manual (applied)* for details of *Pr. 20*.)

Data Name	Initial Value	Range *1	Increments	Setting Value Storage Location
nciRampUpTm	Initial value of <i>Pr. 7</i>	0.0s to 3600.0s	0.1s/bit	<i>Pr. 7</i>
		0.00s to 360.00s	0.01s/bit	

\*1 The setting range changes according to the *Pr. 21 Acceleration/deceleration time increments* setting. At an initial status of *Pr. 21*, the setting range is "0 to 3600.0s" and setting increments is "0.1s".

· Data acceptance timing ..... At network variable receive (nv\_update\_occurs event)

#### REMARKS

Refer to *the inverter manual (applied)* for details of *Pr. 7*

#### CAUTION

The setting increments of acceleration time changes according to the *Pr. 21* setting. The value 0.1 times greater than the setting value is written to the inverter when *Pr. 21* = 1. When the *Pr. 21* setting has been changed, set the acceleration time again.

(Example) When *Pr. 21* = "0" and the setting of acceleration time is "5.0"s, and if the setting of *Pr. 21* is changed to "1", the setting value of acceleration time will change to "0.5" s.

Refer to *the inverter manual (applied)* for details.



## 6.8.9 Deceleration time (network input config SNVT\_time\_sec nciRampDownTm)

You can set the time taken by the motor to decelerate from the set frequency (1 to 400Hz) of Pr. 20 Acceleration/deceleration reference frequency to 0Hz. (Refer to the inverter manual (applied) for details of Pr. 20.)

Data Name	Initial Value	Range *1	Increments	Setting Value Storage Location
nciRampDownTm	Initial value of Pr. 8	0.0s to 3600.0s	0.1s/bit	Pr. 8
		0.00s to 360.00s	0.01s/bit	

\*1 The setting range changes according to the Pr. 21 Acceleration/deceleration time increments setting. At an initial status of Pr. 21, the setting range is "0 to 3600.0s" and setting increments is "0.1s".

· Data acceptance timing .....At network variable receive (nv\_update\_occurs event)

### REMARKS

Refer to the inverter manual (applied) for details of Pr. 8.

### CAUTION

The setting increments of deceleration time changes according to the Pr. 21 setting. The value 0.1 times greater than the setting value is written to the inverter when Pr. 21 = 1. When the Pr. 21 setting has been changed, set the deceleration time again.

(Example) When Pr. 21 = "0" and the setting of deceleration time is "5.0"s, and if the setting of Pr. 21 is changed to "1", the setting value of deceleration time will change to "0.5" s.

Refer to the inverter manual (applied) for details.

### 6.8.10 PID action selection (network input config SNVT\_count nciInvPIDSwitch)

You can set whether the PID control of the inverter will be exercised or not.

Data Name	Initial Value	Range	Increments	Setting Value Storage Location
nciInvPIDSwitch	Initial value of Pr. 128	10, 11, 20, 21, 50, 51, 60, 61, 70, 71, 80, 81, 90, 91, 100, 101,	—	Pr. 128

nciInvPIDSwitch Setting		Description	
state	value		
10	Don't care (not used)	PID reverse action	Deviation value signal input (terminal 1)
11		PID forward action	
20		PID reverse action	Measured value (terminal 4)
21		PID forward action	Set point (terminal 2 or Pr. 133)
50 *1		PID reverse action	Deviation value signal input
51 *1		PID forward action	(LONWORKS, CC-Link communication)
60 *1		PID reverse action	Measured value, set point input
61 *1		PID forward action	(LONWORKS, CC-Link communication)
70 *2		PID reverse action	Deviation value signal input
71 *2		PID forward action	(PLC function)
80 *2		PID reverse action	Measured value, set point input
81 *2		PID forward action	(PLC function)
90 *2		PID reverse action	Deviation value signal input
91 *2		PID forward action	(PLC function) (Not reflected to the inverter frequency)
100 *2		PID reverse action	Measured value, set point input
101 *2		PID forward action	(PLC function) (Not reflected to the inverter frequency)





- Data acceptance timing....At network variable receive when the inverter is at a stop (nv\_update\_occurs event)

### REMARKS

Refer to *the inverter manual (applied)* for use of PID control function.

- \*1 Precautions for 50, 51, 60, 61 settings
  - PID control is made valid independently of ON/OFF of the X14 terminal.
  - Input the set point and setting value (deviation input) in % increments. At this time, the set frequency of C2 (Pr. 902) Terminal 2 frequency setting bias frequency is equivalent to 0 % and the set frequency of Pr. 125 (Pr. 903) Terminal 2 frequency setting gain frequency is equivalent to 100%.
  - The settings of Pr. 338 Communication operation command source and Pr. 339 Communication speed command source are made valid. (Refer to page 21)
  - When Pr. 79 = 6 (switchover mode), both PID function and switchover mode are made invalid.
- \*2 They can be set for the FR-A700-NA/EC only.  
Refer to the FR-A700 PLC function programming manual for details of the PLC function.

### 6.8.11 PID proportional band (network input config SNVT\_count ncilnvPIDPro)

You can set the proportional band of the PID control of the inverter.  
To disable integral control, set "0.0%" or "6553.5".

Data Name	Initial Value	Range	Increments	Setting Value Storage Location
ncilnvPIDPro	Initial value of Pr. 129	0.0% to 1000.0%, 6553.5	0.1%/bit	Pr.129

· Data acceptance timing....At network variable receive when the inverter is at a stop (nv\_update\_occurs event)

Set the value 10 times greater than the desired value in ncilnvPIDPro.  
Example:  
If you want to set 50.0%, set "500", the value 10 times greater than 50.0.

#### REMARKS

Refer to *the inverter manual (applied)* for use of PID control function.

### 6.8.12 PID integral time (network input config SNVT\_time\_sec ncilnvPIDIntTm)

You can set the integral time of the PID control of the inverter.  
To disable integral control, set "0.0s" or "6553.5".

Data Name	Initial Value	Range	Increments	Setting Value Storage Location
ncilnvPIDIntTm	Initial value of Pr. 130	0.0s to 3600.0s, 6553.5	0.1s/bit	Pr.130

· Data acceptance timing....At network variable receive when the inverter is at a stop (nv\_update\_occurs event)

#### REMARKS

Refer to *the inverter manual (applied)* for use of PID control function.



### 6.8.13 PID differential time (network input config *SNVT\_time\_sec nciInvPIDDiffTm*)

You can set the differential time of the PID control of the inverter.  
To disable differential control, set "0.0s" or "6553.5".

Data Name	Initial Value	Range	Increments	Setting Value Storage Location
nciInvPIDDiffTm	Initial value of <i>Pr. 134</i>	0.0s to 10.0s, 6553.5	0.1s/bit	<i>Pr. 134</i>

- Data acceptance timing.....At network variable receive when the inverter is at a stop (nv\_update\_occurs event)

#### **REMARKS**

Refer to *the inverter manual (applied)* for use of PID control.

### 6.8.14 PID manipulated variable bias (0.1Hz increments) (network input config *SNVT\_freq\_hz nciInvPIDOpeBias*)

You can set the manipulated variable of the inverter in 0.1Hz increments when the deviation (difference between set point and measured value) under PID control is 0%.

Data Name	Initial Value	Range	Increments	Setting Value Storage Location
nciInvPIDOpeBias	Initial value of <i>C2 (Pr. 902)</i>	0.0Hz to 400.0Hz	0.1Hz/bit	<i>C2 (Pr. 902)</i>

- Data acceptance timing..... At network variable receive (nv\_update\_occurs event)

#### **REMARKS**

- Refer to *the inverter manual (applied)* for details of *C2 (Pr. 902)*.
- Refer to *the inverter manual (applied)* for use of PID control.

### 6.8.15 PID manipulated variable gain (0.1Hz increments) (network input config SNVT\_freq\_hz nciInvPIDOpeGain)

You can set the manipulated variable of the inverter in 0.1Hz increments when the deviation (difference between set point and process variable) under PID control is 100%.

Data Name	Initial Value	Range	Increments	Setting Value Storage Location
nciInvPIDOpeGain	Initial value of Pr. 125 (Pr. 903)	0.0Hz to 400.0Hz	0.1Hz/bit	Pr.125(Pr.903)

- Data acceptance timing ..... At network variable receive (nv\_update\_occurs event)

#### REMARKS

- Refer to *the inverter manual (applied)* for details of Pr. 125 (Pr.903).
- Refer to *the inverter manual (applied)* for use of PID control.



### 6.8.16 Heartbeat receive time interval (network input config *SNVT\_time\_sec nciRcvHrtBt*)

You can set the time interval at which input network variables data is received from the network. When the receive interval time from the network has risen above the setting, it is considered as a communication line error, then "option alarm (E.OP1 or E.OP3)" is displayed and the inverter stops.

Data Name		Initial Value	Range	Increments
nciRcvHrtBt		0s	0.0s to 999.8s	0.1s/bit
Parameter	Name			
391	Heartbeat receive time interval			

- Data acceptance timing....At network variable receive (nv\_update\_occurs event)

#### REMARKS

For the data send to other nodes, the counters of heartbeat receive time interval are not cleared.

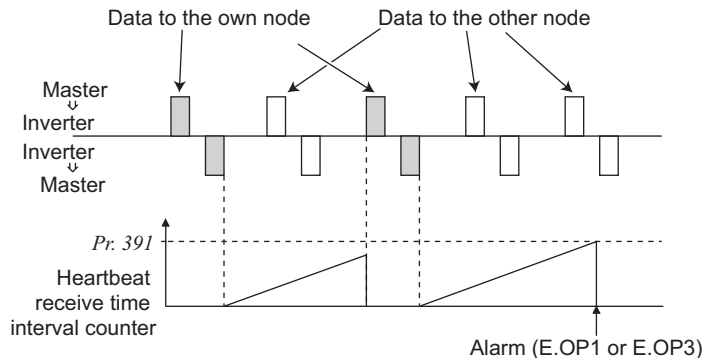

## Network variables supported

The following network variables are subject to the receive interval time.

Function	Network Variables		In/Out	Refer to Page
	Variable	Name		
Start and stop/simple speed setting	SNVT_switch	nviDrvSpeedStpt	In	45
Speed adjustment	SNVT_lev_percent	nviDrvSpeedScale	In	46
Inverter input signal	SNVT_state	nviInvInputSig	In	48
Set frequency (0.1Hz/bit)	SNVT_freq_hz	nviInvSetFreq	In	51
Set frequency (0.005%/bit)	SNVT_lev_percent	nviInvSetFreqP	In	51
PID set point (0.005%/bit)	SNVT_lev_percent	nviInvPIDTarget	In	65
PID measured value (0.005%/bit)	SNVT_lev_percent	nviInvPIDValue	In	66
PID deviation (0.005%/bit)	SNVT_lev_percent	nviInvPIDDev	In	67
Set frequency (0.01Hz/bit)	SNVT_count	nviInvSetFreq2	In	73

### REMARKS

The communication line error detection is invalid when *Pr. 502 Communication alarm stop mode selection* = 3.



### 6.8.17 Maximum speed (0.005% increments) (network input config SNVT\_lev\_percent nciMaxSpeed)

You can set the maximum speed to be output by the inverter to the motor.

Set the speed in 0.005% increments using the setting value of "reference speed setting (nciNmlSpeed) (page 98)" or "reference frequency setting (nciNmlFreq) (page 97)" as reference.

Data Name	Initial Value	Range	Increments	Setting Value Storage Location
nciMaxSpeed	Initial value of Pr. 1	0.000% to 163.830%	0.005%/bit	Pr. 1/Pr. 18

- Data acceptance timing .....At network variable receive (nv\_update\_occurs event)

#### REMARKS

- Refer to *the inverter manual (applied)* for details of Pr. 1 or Pr. 18.
- The setting value exceeding 163.830% is made invalid.
- Control can not be exercised at less than the minimum frequency resolution (0.01Hz) of the inverter.

### 6.8.18 Minimum speed (0.005% increments) (network input config SNVT\_lev\_percent nciMinSpeed)

You can set the minimum speed to be output by the inverter to the motor.

Set the speed in 0.005% increments using the setting value of "reference speed setting (nciNmlSpeed) (page 98)" or "reference frequency setting (nciNmlFreq) (page 98)" as reference.

Data Name	Initial Value	Range	Increments	Setting Value Storage Location
nciMinSpeed	Initial value of Pr. 2	0.000% to 163.830%	0.005%/bit	Pr. 2

- Data acceptance timing .....At network variable receive (nv\_update\_occurs event)

#### REMARKS

- Refer to *the inverter manual (applied)* for details of Pr. 2.
- The setting value exceeding 163.830% is made invalid.
- Control can not be exercised at less than the minimum frequency resolution (0.01Hz) of the inverter.

### 6.8.19 Reference speed setting (network input config SNVT\_rpm nciNmlSpeed)

Set the speed used as the reference of "speed adjustment (nviDrvSpeedScale) (page 46)", "speed monitor (nvoDrvSpeed) (page 47)", "maximum speed (nciMaxSpeed) (page 96)" and "minimum speed (nciMinSpeed) (page 96)".

Data Name	Initial Value	Range	Increments	Setting Value Storage Location
nciNmlSpeed	1800r/min / 1500r/min *	30r/min to 12000r/min	1r/min/bit	Pr. 390

\* 1800r/min for the Japanese and NA version and 1500r/min for the EC and CH version.

- Data acceptance timing.....At network variable receive (nv\_update\_occurs event)

The setting of reference speed setting (nciNmlSpeed) is changed from speed increments to frequency increments, then written to Pr. 390.

$$\text{Frequency} = \frac{\text{Number of motor poles} \times \text{speed}}{120} \quad (\text{the calculation result is rounded down.})$$

- Set the number of motor poles in Pr. 144. (2, 4, 6, 8, 10 poles)
- When Pr. 144 = "0", it is considered as 4 poles.
- The number of motor poles is available with the FR-A700/FP700 series and FR-F700 series inverter assembled in and after September 2004 (55K or less) and in and after August 2004 (75K or more).  
(The inverter type, 55K and 75K differ according to -NA and -EC versions. Refer to page 1.)
- The number of motor poles is always four for the inverter which is not available with the number of motor poles setting. (Refer to page 4)
- Refer to the inverter manual for details of Pr. 144.

#### REMARKS

- Refer to page 82 for details of Pr. 390.





### 6.8.20 Reference frequency setting (network input config SNVT\_freq\_hz nciNmIFreq)

Set the frequency used as the reference of "speed adjustment (nviDrvSpeedScale) (page 46)", "speed monitor (nvoDrvSpeed) (page 47)", "maximum speed (nciMaxSpeed) (page 96)" and "minimum speed (nciMinSpeed) (page 96)".

Data Name	Initial Value	Range	Increments	Setting Value Storage Location
nciNmIFreq	60Hz / 50Hz *	1.0Hz to 400.0Hz	0.1Hz/bit	Pr. 390

\* 60Hz for the Japanese and NA version and 50Hz for the EC and CH version.

- Data acceptance timing ..... At network variable receive (nv\_update\_occurs event)

#### REMARKS

- Refer to page 82 for details of Pr. 390.
- To make the change of "reference frequency setting (nciNmIFreq)" be reflected to the operation speed, a value is need to be written to speed adjustment (nviDrvSpeedScale)

### 6.8.21 Speed adjustment default value (network input config SNVT\_lev\_percent nciDrvSpeedScale)

You can set the default value of "speed adjustment (nviDrvSpeedScale) (Refer to page 46).

Data Name	Initial Value	Range	Increments	Setting Value Storage Location
nciDrvSpeedScale	100.00%	-163.840% to 163.830%	0.005%/bit	—

- Data acceptance timing ..... At network variable receive (nv\_update\_occurs event)

#### REMARKS

- Write and read the setting value from the network. You can not read and write from the inverter.
- The value stored in the inverter is rounded up. For example, 1.005% is rounded up to 1.010%.

### 6.8.22 Event driven detection width (network input config SNVT\_lev\_percent nciInvEvtDuty)

You can set the event driven detection width (varying width) of the monitor-related output network variables.

A 100% value that will be the basis of the detection width varies with the network variables.

This setting can reduce traffic jams caused by occurrence of many send events due to consecutive value changes.

Data Name		Initial Value	Range	Increments
nciInvEvtDuty		0%	0.000% to 163.830%	0.005%/bit
Parameter	Name		0.00 to 163.83%	0.01%
392	Event driven detection width			

- Data acceptance timing .....At network variable receive (nv\_update\_occurs event)

#### REMARKS

- Control can not be exercised at less than the minimum frequency resolution (0.01Hz) of the inverter.
- The value stored in the inverter is rounded up. For example, 1.005% is rounded up to 1.010%.
- When the inverter operation status has changed, e.g. from a stop to startup or from running to a stop, the monitor value is output even when the value is within the event driven detection width.

**Example: when the output frequency monitor and event driven detection width (Pr. 392) = 100%, reference value (Pr. 390) = set frequency = 60Hz**

As the monitor is output once at starting from the stop status, the starting monitor output is 0.5Hz when the starting frequency is set to 0.5Hz. Therefore, the second monitor output is equal to or more than "0.5Hz+60Hz (Pr. 390 setting × Pr. 392 setting)" = "60.5Hz". (This is not the monitor output when the frequency reaches 60Hz. Use the SU signal to detect output frequency, etc.)



- Network variables that allow setting of event driven detection width

Name of Network Variables	In/Out	100% Value	Formula of Detection Width (0.005% increments)	Refer to Page
Speed monitor (0.005%/bit) SNVT_lev_percent nvoDrvSpeed	Out	—	As network variables supported and SNVT of detection width are the same type, set the value directly.	47
Output frequency monitor (0.1Hz/bit) SNVT_freq_hz nvolnvOutFreq	Out	% set reference frequency	$\frac{\text{Varying width of frequency monitor value}}{\% \text{ setting reference frequency}} \times 100\%$	52
Output frequency monitor (0.005%/bit) SNVT_lev_percent nvolnvOutFreqP	Out	—	As network variables supported and SNVT of detection width are the same type, set the value directly.	53
Output current monitor (0.1A/bit) SNVT_amp nvoDrvCurnt	Out	Rated inverter current	$\frac{\text{Varying width of current monitor value}}{\text{Rated inverter current}} \times 100\%$	54
Output voltage monitor (0.1V/bit) SNVT_volt nvoDrvVolt	Out	Rated inverter voltage (200V class: 200VAC, 400V class: 400VAC)	$\frac{\text{Varying width of voltage monitor value}}{\text{Rated inverter voltage}} \times 100\%$	54
Monitor data SNVT_count nvolnvMonData	Out	The reference value of 100% differs according to the monitor description. (Refer to page 68)	$\frac{\text{Varying width of monitor data value}}{\text{Reference value of each monitor}} \times 100\%$	72
Output frequency monitor (0.01Hz/bit) SNVT_count nvolnvOutFreq2	Out	% set reference frequency	$\frac{\text{Varying width of frequency monitor value}}{\% \text{ setting reference frequency}} \times 100\%$	73
Cumulative power monitor 2 (0.1kWh/bit) SNVT_elec_kwh_l nvoDrvRunPower_l	Out	Rated inverter power × 2	$\frac{\text{Varying width of cumulative power monitor value}}{\text{Rated inverter power} \times 2} \times 100\%$	56

Method for event driven detection... | Previous value - present value | ≥ event driven detection width

# 7 FREQUENCY AND SPEED CONVERSION SPECIFICATIONS

When the running speed monitor is selected, each monitor and setting are determined by the combination of Pr. 37 and Pr. 144 as listed below. (The units within the thick frame are the initial values.)

Pr. 37 Setting	Pr. 144 Setting	Output Frequency Monitor	Set Frequency Monitor	Running Speed Monitor	Frequency Setting Parameter Setting
0 (initial value)	0	Hz	Hz	r/min *1	Hz
	2 to 10	Hz	Hz	r/min *1	Hz
	102 to 110	Hz (r/min) *3	Hz (r/min) *3	r/min *1	Hz (r/min) *3
1 to 9998	0	Hz	Hz	Machine speed *1	Hz
	2 to 10	Hz (Machine speed) *3	Hz (Machine speed) *3	Machine speed *1	Hz (Machine speed) *3
	102 to 110	Hz	Hz	r/min *1	Hz

\*1 Motor speed r/min conversion formula ..... frequency  $\times$  120/number of motor poles (Pr. 144)

Machine speed conversion formula ..... Pr. 37  $\times$  frequency/60Hz\*

\* When using the FR-A700 series, the Pr.505 setting is used.

(Pr. 505 is always set as frequency (Hz).)

For Pr. 144 in the above formula, the value is "Pr. 144-100" when "102 to 110" is set in Pr. 144 and the value is "4" when Pr. 37 = 0 and Pr. 144 = 0.

\*2 The increments for Hz are 0.01Hz, machine speed are 1m/min, and r/min are 1r/min.

\*3 When the FR-A7NL is not mounted, the unit of the value is as in parenthesis.

## REMARKS

Refer to the inverter manual (applied) for details of Pr. 37, Pr. 144, and Pr. 505.

## 8 TROUBLESHOOTING

### Operation mode does not switch to network operation mode.

- Check that the communication option (FR-A7NL) and LONWORKS dedicated cables are fitted properly. (Check for contact fault, break in the cable, etc.)
- Check that the node addresses are set to the correct positions.
- Check that operation mode switchover conditions are satisfied. (*Refer to page 17*)
- Check that the operation mode switching network variable is running.
- Check that the operation mode switching network variable has been written correctly.

### The inverter does not start in network operation mode.

- Check that the inverter starting network variable has been written correctly.
- Check that the inverter starting network variable is running.

### When "E.OP1", "E.OP3", "E.1" or "E.3" is displayed

- Refer to *page 30*.

## Setup Example

The following is an example of procedure to perform LONWORKS communication with the FR-A7NL.

### (1) Confirmation of installation and connection

- 1) Check that the FR-A7NL is mounted on the option connector of the inverter. *(Refer to page 8)*
- 2) Check that the twisted pair cable is connected to NET\_A and NET\_B of the terminal block supplied securely. *(Refer to page 11)*
- 3) Check that the terminating resistor is connected with a LONWOKRS cable. (Please fabricate a terminating resistor.) *(Refer to page 10)*

### (2) Parameter setting of the inverter (when the network operation mode is always set)

- 1) Set "0" (simple mode+extended parameters display) in *Pr. 160 User group read selection*.
- 2) Set a value other than "0" in *Pr. 340 Communication startup mode selection*. *(Refer to page 17)*
- 3) Set "0 or 2" in *Pr. 79 Operation mode selection*. *(Refer to page 17)*

### REMARKS

By making parameter setting of 2) and 3) above, the inverter operates in network operation mode when the inverter power is switched on. (It is not necessary to change the operation mode with network variables.)

### (3) Switch on the inverter power from off

Power on the inverter (inverter reset) again to change the mode to network operation mode.

### (4) Perform LONWORKS communication setting

Perform LONWORKS communication setting with software necessary for LONWORKS communication such as "LonMaker for Windows, Visio 2000". (For a setting method, refer to the manual of software used.) Communication setting is complete if "SERVICE" LED of the FR-A7NL is not flickering.

### (5) Check the status of the network variables

- 1) Power on the inverter (inverter reset) again and reflect the current network variables of the inverter to LonMaker Browser.
- 2) Set LonMaker Browser to "Monitor All On" to turn on monitoring of the inverter network variables. (When "Monitor All OFF" is set, only the initial value of network variables the inverter sent to LonMaker Browser can be referred. To always check network variables, set "Monitor All On".)

### (6) Setup is completed



## Example of Inverter Parameter Clear

The following shows procedure to make LONWORKS communication again when inverter parameter clear is performed from LONWORKS communication.

### (1) Perform parameter clear

Perform parameter clear via network or with the operation panel or parameter unit.

When performing with the operation panel or parameter unit, the procedure is the same as that of the inverter.

When performing via the network (LONWORKS), use the command request (SNVT\_str\_asc nvilnvCmdReq) of network variables.

Data set by command request:  
Request flag = H01  
Request code = H00FC  
Request data = H5A5A, H55AA

- Parameter for communication is also cleared when H9696 and H9966 are set as request data.

*(Refer to page 74)*

- When Pr. 79 = "2", resetting is necessary as the set value is cleared.

### (2) Check the status of the network variables

Set LonMaker Browser to "Monitor All On" to turn on monitoring of the inverter network variables.

(When "Monitor All OFF" is set, only the initial value of network variables the inverter sent to LonMaker Browser can be referred. To always check network variables, set "Monitor All On".)

### (3) LONWORKS communication resetting is complete

## REVISIONS

\*The manual number is given on the bottom left of the back cover.

Print Date	*Manual Number	Revision
May, 2004	IB(NA)-0600168ENG-A	First edition
Jul., 2004	IB(NA)-0600168ENG-B	<p data-bbox="546 240 662 274">Addition</p> <p data-bbox="546 281 1278 336">Compatible with the FR-F700 series 75K or more Compatible with the FR-F700-EC series and FR-F700-CH series.</p>
Nov., 2004	IB(NA)-0600168ENG-C	<p data-bbox="546 353 778 387">Partial modification</p> <p data-bbox="546 394 1240 422">Selection of number of motor poles of reference speed setting</p> <p data-bbox="546 429 662 464">Addition</p> <p data-bbox="546 471 1001 526">Compatible with the FR-F700-NA series. Cumulative power monitor 2</p>
Dec., 2005	IB(NA)-0600168ENG-D	<p data-bbox="546 539 662 573">Addition</p> <p data-bbox="546 581 958 609">Compatible with the FR-A700 series.</p>