

MELSEC ST Series

Programmable Logic Controllers

User's Manual (CC-Link)

SSI Absolute Encoder Input Module ST1SS1

● SAFETY PRECAUTIONS ●

(Read these precautions before using.)

When using this product, thoroughly read this manual and the associated manuals introduced in this manual. Also pay careful attention to safety and handle the product properly.

The precautions given in this manual are concerned with this product only. Refer to the user's manual of the network system for safety precautions of the network system.

In this manual, safety precautions are classified into two categories: "DANGER" and "CAUTION".



DANGER

Indicates that incorrect handling may cause hazardous conditions, resulting in death or severe injury.



CAUTION

Indicates that incorrect handling may cause hazardous conditions, resulting in minor or moderate injury or property damage.

Depending on circumstances, failure to observe  CAUTION level precautions may also lead to serious results.

Be sure to observe the instructions of both levels to ensure the safety.

Store this manual in a safe place for future reference and also pass it on to the end user.

[DESIGN PRECAUTIONS]

DANGER

- Create an interlock circuit on the program so that the system will operate safely based on the communication status information. Failure to do so may cause an accident due to an erroneous output or malfunction.

When an error occurs, all outputs are turned off in the MELSEC-ST system. (At default)

However, I/O operations of the head module and respective slice modules can be selected for the following errors:

(1) Communication error (☞ MELSEC-ST CC-Link Head Module User's Manual "4.3.1 Output status setting for module error")

(2) Slice module error

The output status for the case of an error can be set to Clear, Hold, or Preset with a command parameter of each slice module. (For the setting availability, refer to each slice module manual.)

Since the parameter is set to Clear by default, outputs will be turned off when an error occurs.

This parameter setting can be changed to Hold or Preset when the system safety is more ensured by holding or presetting the output.

[DESIGN PRECAUTIONS]

DANGER

- Create an external failsafe circuit so that the MELSEC-ST system will operate safely, even when the external power supply or the system fails.
Failure to do so may cause an accident due to an erroneous output or malfunction.
 - (1) The status of output changes depending on the setting of various functions that control the output. Take sufficient caution when setting those functions.
 - (2) Outputs may be kept ON or OFF due to malfunctions of output elements or the internal circuits.
For signals that may cause a serious accident, configure an external monitoring circuit.

[DESIGN PRECAUTIONS]

CAUTION

- Make sure to initialize the network system after changing parameters of the MELSEC-ST system or the network system. If unchanged data remain in the network system, this may cause malfunctions.
- Do not install the control wires or communication cables together with the main circuit or power wires. Keep a distance of 100 mm (3.94 inch) or more between them. Not doing so could result in malfunctions due to noise.

[INSTALLATION PRECAUTIONS]

CAUTION

- Use the MELSEC-ST system in the general environment specified in the MELSEC-ST system users manual. Using this MELSEC-ST system in an environment outside the range of the general specifications could result in electric shock, fire, erroneous operation, and damage to or deterioration of the product.
- Mount the head module and base module(s) on the DIN rail securely (one by one) referring to the MELSEC-ST system users manual and then fix them with stoppers. Incorrect mounting may result in a fall of the module, short circuits or malfunctions.
- Secure the module with several stoppers when using it in an environment of frequent vibration. Tighten the screws of the stoppers within the specified torque range. Undertightening can cause a drop, short circuit or malfunction. Overtightening can cause a drop, short circuit or malfunction due to damage to the screw or module.
- Make sure to externally shut off all phases of the power supply for the whole system before mounting or removing a module. Failure to do so may damage the module.
 - (1) Online replacement of the power distribution module and/or the base module is not available. When replacing either of the modules, shut off all phases of the external power supply. Failure to do so may result in damage to all devices of the MELSEC-ST system.
 - (2) The I/O modules and the intelligent function modules can be replaced online. Since online replacement procedures differ depending on the module type, be sure to make replacement as instructed. For details, refer to the chapter of online module change in this manual.
- Do not directly touch the module's conductive parts or electronic components. Doing so may cause malfunctions or failure of the module.
- Make sure to securely connect each cable connector. Failure to do so may cause malfunctions due to poor contact.
- DIN rail must be conductive; make sure to ground it prior to use. Failure to do so may cause electric shocks or malfunctions. Undertightening can cause a short circuit or malfunction. Overtightening can cause a short circuit due to damage to the screw.

[WIRING PRECAUTIONS]

DANGER

- Completely turn off the external power supply when installing or placing wiring. Not completely turning off all power could result in electric shock or damage to the product.
- Place the SSI absolute encoder signal cable at least 100mm (3.94inch) away from the main circuit cables and AC control lines.
Especially, ensure a sufficient distance from high-voltage cables or any harmonic circuit such as an inverter's load circuit.
Failure to do so will make the module more susceptible to noise, surge and induction.

CAUTION

- Make sure to ground the control panel where the MELSEC-ST system is installed in the manner specified for the MELSEC-ST system. Failure to do so may cause electric shocks or malfunctions.
- Check the rated voltage and the terminal layout and wire the system correctly. Connecting an inappropriate power supply or incorrect wiring could result in fire or damage.
- Tighten the terminal screws within the specified torque range. If the terminal screws are loose, it could result in short circuits or erroneous operation. Overtightening may cause damages to the screws and/or the module, resulting in short circuits or malfunction.
- Prevent foreign matter such as chips or wiring debris from entering the module. Failure to do so may cause fires, damage, or erroneous operation.
- When connecting the communication and power supply cables to the module, always run them in conduits or clamp them. Not doing so can damage the module and cables by pulling a dangling cable accidentally or can cause a malfunction due to a cable connection fault.
- When disconnecting the communication and power supply cables from the module, do not hold and pull the cable part. Disconnect the cables after loosening the screws in the portions connected to the module. Pulling the cables connected to the module can damage the module and cables or can cause a malfunction due to a cable connection fault.

[STARTUP AND MAINTENANCE PRECAUTIONS]

DANGER

- Do not touch the terminals while power is on.
Doing so could cause shock or erroneous operation.
- Make sure to shut off all phases of the external power supply for the system before cleaning the module or tightening screws.
Not doing so can cause the module to fail or malfunction.

[STARTUP AND MAINTENANCE PRECAUTIONS]

CAUTION

- Do not disassemble or modify the modules.
Doing so could cause failure, erroneous operation, injury, or fire.
- Do not drop or give a strong impact to the module since its case is made of resin. Doing so can damage the module.
- Make sure to shut off all phases of the external power supply for the system before mounting/removing the module onto/from the control panel. Not doing so can cause the module to fail or malfunction.
- Before handling the module, make sure to touch a grounded metal object to discharge the static electricity from the human body.
Failure to do so may cause a failure or malfunctions of the module.
- When using any radio communication device such as a cellular phone, keep a distance of at least 25cm (9.85 inch) away from the MELSEC-ST system in all directions.
Not doing so can cause a malfunction.

[DISPOSAL PRECAUTIONS]

CAUTION

- When disposing of this product, treat it as industrial waste.

REVISIONS

* The manual number is given on the bottom left of the back cover.

Print Date	*Manual Number	Revision
Sep., 2008	SH(NA)-080759ENG-A	First edition

Japanese Manual Version SH-080753-A

This manual confers no industrial property rights or any rights of any other kind, nor does it confer any patent licenses. Mitsubishi Electric Corporation cannot be held responsible for any problems involving industrial property rights which may occur as a result of using the contents noted in this manual.

© 2008 MITSUBISHI ELECTRIC CORPORATION

INTRODUCTION

Thank you for choosing the ST1SS1 MELSEC-ST SSI absolute encoder input module.
Before using the module, please read this manual carefully to fully understand the functions and performance of the ST1SS1 MELSEC-ST SSI absolute encoder input module and use it correctly.

CONTENTS

SAFETY PRECAUTIONS	A - 1
REVISIONS	A - 6
INTRODUCTION	A - 7
CONTENTS	A - 7
About Manuals	A - 10
Compliance with the EMC and Low Voltage Directives	A - 10
How to Read Manual	A - 11
Generic Terms and Abbreviations	A - 13
Term definition	A - 14
Packing list	A - 15

CHAPTER1 OVERVIEW **1 - 1 to 1 - 3**

1.1 Features	1 - 2
--------------	-------

CHAPTER2 SYSTEM CONFIGURATION **2 - 1 to 2 - 3**

2.1 Overall Configuration	2 - 1
2.2 Applicable System	2 - 2
2.2.1 Applicable head module	2 - 2
2.2.2 Applicable base module	2 - 2
2.2.3 Applicable coding element	2 - 2
2.2.4 Applicable software package	2 - 2
2.3 Precautions for System Configuration	2 - 3

CHAPTER3 SPECIFICATIONS **3 - 1 to 3 - 18**

3.1 Performance Specifications	3 - 1
3.1.1 Data update cycle of the ST1SS1	3 - 2
3.1.2 Intelligent function module processing time	3 - 4
3.2 Functions	3 - 5
3.2.1 Function list	3 - 5
3.2.2 Counter function	3 - 9
3.2.3 SSI monoflop time setting function	3 - 10
3.2.4 Latch counter function	3 - 11
3.2.5 Coincidence detection function	3 - 12
3.3 I/O Data	3 - 14
3.3.1 Bit input area	3 - 14

3.3.2	Word input area	3 - 15
3.3.3	Bit output area	3 - 16
3.4	Memory and Parameters	3 - 18
3.4.1	Memory	3 - 18
3.4.2	Parameters	3 - 19

CHAPTER4 SETUP AND PROCEDURES BEFORE OPERATION **4 - 1 to 4 - 10**

4.1	Handling Precautions	4 - 1
4.2	Setup and Procedure before Operation	4 - 2
4.3	Part Names	4 - 3
4.3.1	Status confirmation by LEDs	4 - 5
4.4	Wiring	4 - 6
4.4.1	Wiring precautions	4 - 6
4.4.2	External wiring	4 - 7
4.4.3	Cable connected between the ST1SS1 and absolute encoder	4 - 10

CHAPTER5 GX Configurator-ST **5 - 1 to 5 - 9**

5.1	GX Configurator-ST Functions	5 - 1
5.2	Creating a Project	5 - 2
5.3	Parameter Setting	5 - 3
5.4	Input/Output Monitor	5 - 6
5.5	Forced Output Test	5 - 8

CHAPTER6 PROGRAMMING **6 - 1 to 6 - 26**

6.1	Programming Procedure	6 - 1
6.2	System Configuration Example	6 - 4
6.3	Settings and Communication Data	6 - 5
6.4	Program Examples	6 - 9

CHAPTER7 ONLINE MODULE CHANGE **7 - 1 to 7 - 11**

7.1	Precautions for Online Module Change	7 - 1
7.2	Preparations for Online Module Change	7 - 3
7.3	Disconnecting/Connecting the External Device for Online Module Change	7 - 3
7.4	Online Module Change Procedure	7 - 4
7.4.1	When parameter setting is performed using GX Configurator-ST during online module change	7 - 4

CHAPTER8 COMMANDS **8 - 1 to 8 - 45**

8.1	Command List	8 - 1
8.2	Common Commands	8 - 3
8.2.1	Operating status read request (Command No.: 8100H/0100H)	8 - 3
8.2.2	Error code read request (Command No.: 8101H/0101H)	8 - 5

8.3	Initial Data Write Command	8 - 7
8.3.1	Initial data batch write request (Command No.: 8106H)	8 - 7
8.3.2	Initial data individual write request (Command No.: 8107H/0107H)	8 - 10
8.4	ST1SS1 Parameter Setting Read Commands	8 - 13
8.4.1	Initial data setting read (Command No.: 9500H/1500H)	8 - 13
8.4.2	SSI trailing bits setting read (Command No.: 9501H/1501H)	8 - 15
8.4.3	SSI monoflop time setting read (Command No.: 9502H/1502H)	8 - 17
8.4.4	Latch mode setting read (Command No.: 9503H/1503H)	8 - 19
8.4.5	Coincidence detection flag setting read (Command No.: 9504H/1504H)	8 - 21
8.4.6	Coincidence detection value read (Command No.: 9505H/1505H)	8 - 23
8.5	ST1SS1 Parameter Setting Write Commands	8 - 25
8.5.1	SSI trailing bits setting write (Command No.: A501H/2501H)	8 - 25
8.5.2	SSI monoflop time setting write (Command No.: A502H/2502H)	8 - 27
8.5.3	Latch mode setting write (Command No.: A503H/2503H)	8 - 30
8.5.4	Coincidence detection flag setting write (Command No.: A504H/2504H)	8 - 33
8.5.5	Coincidence detection value write (Command No.: A505H/2505H)	8 - 36
8.6	ST1SS1 Control Commands	8 - 39
8.6.1	Parameter setting read from ROM (Command No.: B500H/3500H)	8 - 39
8.6.2	Parameter setting write to ROM (Command No.: B501H/3501H)	8 - 41
8.7	Values Stored into Command Execution Result	8 - 43

CHAPTER9 TROUBLESHOOTING

9 - 1 to 9 - 4

9.1	Error Code List	9 - 1
9.2	Troubleshooting	9 - 3
9.2.1	When the RUN LED is flashing or turned off	9 - 3
9.2.2	When the RUN LED and the ERR. LED turned on	9 - 4
9.2.3	When counting is not performed	9 - 4
9.2.4	When encoder values are not correct	9 - 4

APPENDIXES

App - 1 to App - 3

Appendix 1	Accessories	App - 1
Appendix 2	External Dimensions	App - 2

INDEX

Index - 1 to Index - 2

About Manuals

The following manuals are related to this product.
Referring to this list, please request the necessary manuals.

Relevant Manuals

Manual Name	Manual Number (Model Code)
MELSEC-ST System User's Manual Explains the system configurations of the MELSEC-ST system and the performance specifications, functions, handling, wiring and troubleshooting of the power distribution modules, base modules and I/O modules. (Sold separately)	SH-080456ENG (13JR72)
MELSEC-ST CC-Link Head Module User's Manual Explains the system configurations, specifications, functions, handling, wiring and troubleshooting of the ST1H-BT. (Sold separately)	SH-080754ENG (13JR68)
GX Configurator-ST Version 1 Operating Manual Explains how to operate GX Configurator-ST, how to set the intelligent function module parameters, and how to monitor the MELSEC-ST system. (Sold separately)	SH-080439ENG (13JU47)
CC-Link System Master/Local Module User's Manual Describes the system configurations, performance specifications, functions, handling, wiring and troubleshooting of the QJ61BT11N. (Sold separately)	SH080394E (13JR64)

Compliance with the EMC and Low Voltage Directives

(1) For MELSEC-ST system

To configure a system meeting the requirements of the EMC and Low Voltage Directives when incorporating the Mitsubishi MELSEC system (EMC and Low Voltage Directives compliant) into other machinery or equipment, refer to Chapter 11 "EMC AND LOW VOLTAGE DIRECTIVES" of the MELSEC-ST System User's Manual. The CE mark, indicating compliance with the EMC and Low Voltage Directives, is printed on the rating plate of the MELSEC-ST system.

(2) For this product

No additional measures are necessary for the compliance of this product with the EMC and Low Voltage Directives.

How to Read Manual

This manual explains each area for the CC-Link remote I/O, remote registers, and message transmission using **Br**, **Wr**, **Cr**, **Bw**, **Ww**, and **Cw**.

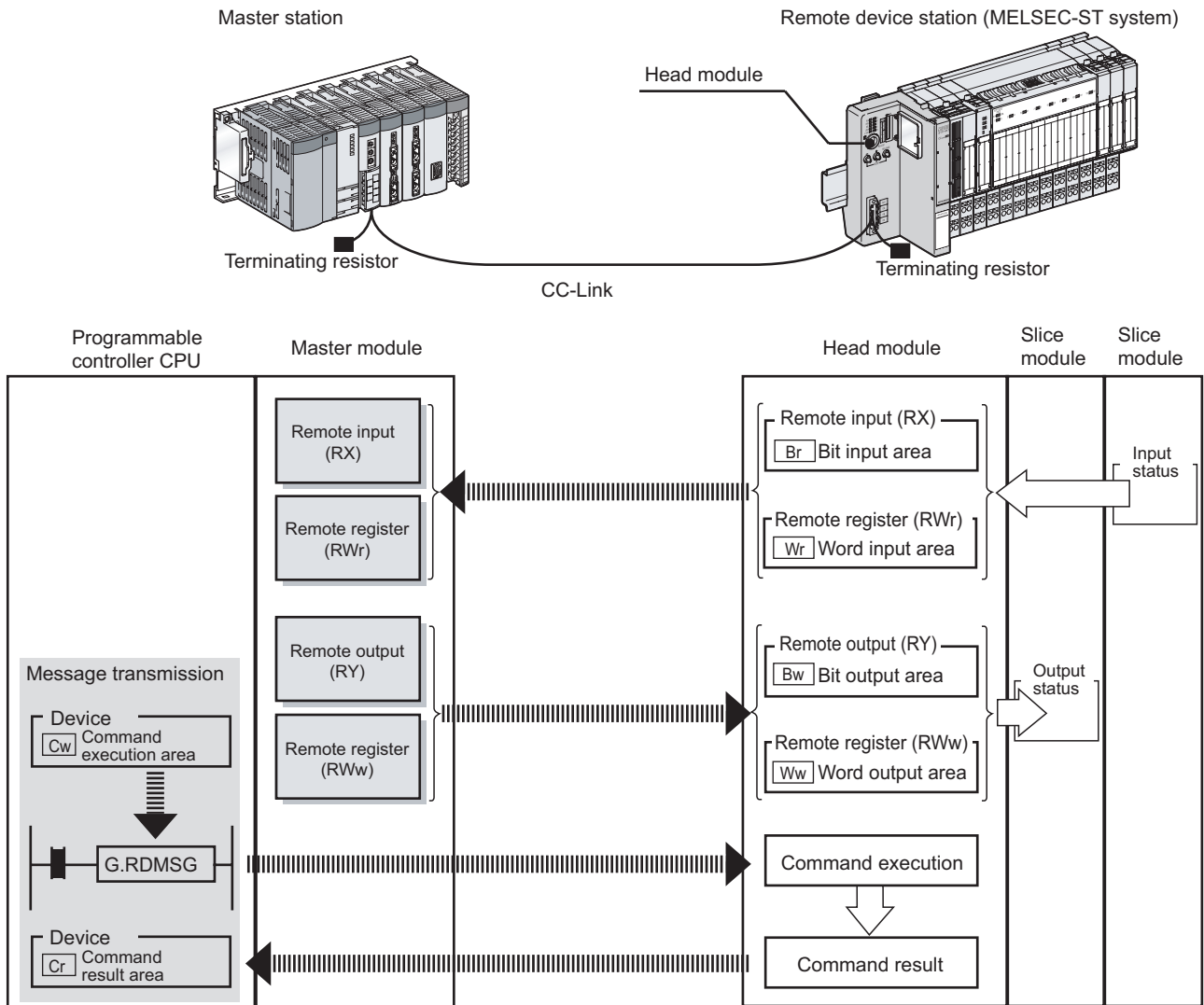

(1) Data symbol

<Example of **Cr** Command result area>

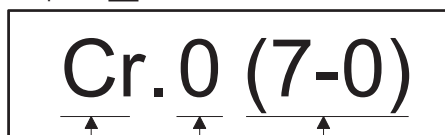

Range
When the unit of data is one word (16 bits),
the corresponding bits are indicated.
(0) : Bit 0
(7-0): Range of bit 0 to bit 7

Detail data No.

Abbreviated data symbol

(2) Head module → Master station, (3) Master station → Head module

(2) Head module → Master station

(a) Remote input (RX)

Data symbol	Area	Unit	Detail data No. notation
Br	Br.00 to Br.n	Bit Input Area	1 bit/symbol Hexadecimal

(b) Remote register (RWr)

Data symbol	Area	Unit	Detail data No. notation
Wr	Wr.00 to Wr.n	Word Input Area	1 word/symbol Hexadecimal

(c) Message transmission

Data symbol	Area	Unit	Detail data No. notation
Cr	Cr.0 to Cr.n	Command Result Area	1 word/symbol Decimal

(3) Master station → Head module

(a) Remote output (RY)

Data symbol	Area	Unit	Detail data No. notation
Bw	Bw.00 to Bw.n	Bit output Area	1 bit/symbol Hexadecimal

(b) Remote register (RWw)

Data symbol	Area	Unit	Detail data No. notation
Ww	Ww.00 to Ww.n	Word output Area	1 word/symbol Hexadecimal

(c) Message transmission

Data symbol	Area	Unit	Detail data No. notation
Cw	Cw.0 to Cw.n	Command execution Area	1 word/symbol Decimal

Generic Terms and Abbreviations

This manual uses the following generic terms and abbreviations to describe the ST1AD, unless otherwise specified.

Generic Term/ Abbreviation	Description
ST1AD2-V	Abbreviation for ST1AD2-V MELSEC-ST analog-digital converter module.
ST1AD2-I	Abbreviation for ST1AD2-I MELSEC-ST analog-digital converter module.
ST1AD	Generic term for ST1AD2-V and ST1AD2-I.
Head module	ST1H-BT, MELSEC-ST CC-Link head module.
Bus refreshing module	Module that distributes external system power and auxiliary power to the head module and slice modules.
Power feeding module	Module that distributes external auxiliary power to slice modules.
Power distribution module	Generic term for bus refreshing module and power feeding module.
Base module	Module that transfers data/connects between the head module and slice modules, and between slice modules and external devices.
Input module	Module that handles input data in bit units.
Output module	Module that handles output data in bit units.
Intelligent function module	Module that handles input/output data in word units.
I/O module	Input module and output module.
Slice module	Module that can be mounted to the base module: power distribution module, I/O module and intelligent function module.
MELSEC-ST system	System that consists of head module, slice modules, end plates and end brackets.
GX Configurator-ST	Configuration software dedicated to the MELSEC-ST system. The general name of SWnD5C-STPB-E type products.(n=1 or later)
CC-Link	Abbreviation for Control and Communication Link system.
Master module	Abbreviation for the QJ61BT11N when it is used as a master station.
RDMSG	Abbreviation for dedicated instruction of master station.

Term definition

The following explains the meanings and definitions of the terms used in this manual.

Term	Definition
Cyclic transmission	A communication method by which remote I/O data and remote register data are transferred periodically.
Message transmission	A transmission method for writing parameters from the master station to a remote device station and reading the remote device station status.
Master station	This station controls the entire data link system. One master station is required for one system.
Remote I/O station	A remote station that can only use bit data. (Input from or output to external devices) (AJ65BTB1-16D, AJ65SBTB1-16D, etc.)
Remote device station	A remote station that can use both bit and word data. (Input from or output to external devices, or analog data conversion) (ST1H-BT, AJ65BT-64AD, AJ65BT-64DAV, AJ65BT-64DAI, etc.)
SB	Link special relay (for CC-Link). Bit data that indicate the module operating status and data link status of the master/local station.
SW	Link special register (for CC-Link) Data in units of 16 bits, which indicate the module operating status and data link status of the master/local station.
RX	Remote input (for CC-Link). Bit data that are input from remote stations to the master station.
RY	Remote output (for CC-Link) Bit data that are output from the master station to remote stations.
RWr	Remote register. (CC-Link data read area) 16-bit word data that are input from remote device stations to the master station.
RWw	Remote register. (CC-Link data write area) 16-bit word data that are output from the master station to remote device stations.
Remote net Ver.1 mode	Select this mode when extended cyclic setting is not needed or when the QJ65BT11 is replaced with the QJ65BT11N.
Remote net Ver.2 mode	Select this mode when creating a new system with extended cyclic setting.
I/O data	Data that are sent/received between the head module and the master station. Generic term for RX, RY, RWr, and RWw.
<input type="checkbox"/> Br.n bit input area	Bit input data of each module. Input data are sent from the head module to the master station through the remote input (RX).
<input type="checkbox"/> Bw.n bit output area	Bit output data of each module. Output data are sent from the master station and received to the head module through the remote output (RY).
<input type="checkbox"/> Wr.n word input area	Word (16-bit) input data of an intelligent function module. Input data are sent from the head module to the master station through the remote register (RWr).
<input type="checkbox"/> Ww.n word output area	Word (16-bit) output data of an intelligent function module. Output data are sent from the master station and received to the head module through the remote register (RWw).
<input type="checkbox"/> Cr.n command result area	An area for the information that indicates a command result. This information is stored in Setting data ((D1)+1 and after) of the RDMSG instruction of the master station.
<input type="checkbox"/> Cw.n command execution area	An area for the information for executing a command. This information is stored in Setting data ((S2)+1 and after) of the RDMSG instruction of the master station.

Term	Definition
Number of occupied I/O points	The area, that is equivalent to the occupied I/O points, is occupied in <input type="text" value="Br"/> bit input area/ <input type="text" value="Bw"/> bit output area.
Slice No.	The number assigned to every 2 occupied I/O points of each module. The numbers are assigned in ascending order, starting from "0" of the head module. (The maximum value is 127). This is used for specifying a command execution target.
Slice position No.	The number that shows where the slice module is physically installed. The numbers are assigned in ascending order, starting from "0" of the head module. (The maximum value is 63.) This is used for specifying a command execution target.
Start slice No.	The start slice No. assigned to the head module and slice modules.
Command	Generic term for requests that are executed by the master station for reading each module's operation status, setting intelligent function module command parameters or various controls.
Command parameter	Generic term for parameters set in commands or GX Configurator-ST. All of the parameters set for the head module and slice modules are command parameters.

Packing list

One of the following ST1AD products is included.

Model name	Product name	Quantity
ST1SS1	ST1SS1 MELSEC-ST absolute encoder input module	1

CHAPTER1 OVERVIEW

This User's Manual provides the specifications, handling instructions, programming methods for the ST1SS1 MELSEC-ST SSI absolute encoder input module (hereinafter referred to as the ST1SS1).

SSI is an abbreviation for the Synchronous Serial Interface.

This manual includes descriptions of the ST1SS1 only.

For information on the MELSEC-ST system, refer to the MELSEC-ST System User's Manual.

The ST1SS1 is designed to be connected to an absolute encoder that has the SSI communication function (hereinafter referred to as the SSI absolute encoder), and thereby it can load positioning data sent from the encoder.

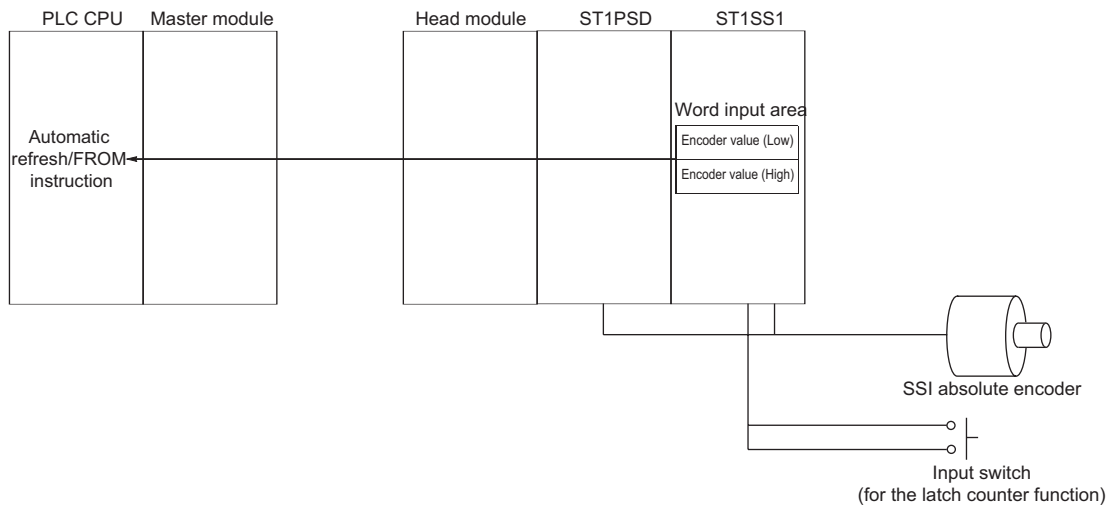

Figure 1.1 Overview

1.1 Features

(1) Up to 26 ST1SS1s are connectable.

To a single head module, up to 26 ST1SS1 modules (52 channels) can be mounted.

(2) Connectable with an SSI absolute encoder

The ST1SS1 can be connected to an SSI absolute encoder, especially, the one having trailing bits (signals indicating the status of the encoder) since the number of trailing bits can be set.

(3) Selection of gray or binary code is available.

An SSI code type appropriate to the connected SSI absolute encoder can be selected from two options (Gray code and Binary code).

The ST1SS1 always outputs binary data to a head module. (When Gray code is selected, the ST1SS1 converts values to binary data.)

(4) SSI baud rate is selectable.

The SSI baud rate for communication with the SSI absolute encoder is selectable from 125kHz, 250kHz, 500kHz, 1MHz, and 2MHz, so that the ST1SS1 is applicable to a variety of systems.

(5) SSI code length setting suitable for resolution of SSI absolute encoder

The ST1SS1 supports SSI absolute encoders of 2- to 31-bit resolution, and the SSI code length can be set within the range from 2 to 31 bits.

(6) Digital input encoder values can be latched. (Latch counter function)

Since 1-point digital input for the latch function is provided, the ST1SS1 can latch the encoder value when a signal is input by an input switch, etc.

(7) Rotational direction of SSI absolute encoder is detectable.

The ST1SS1 has two LEDs that indicate rotational directions of the SSI absolute encoder, so that its incrementing or decrementing count can be confirmed with the LEDs.

(8) Rotational direction can be reversed.

Incrementing or decrementing count corresponding to the rotational direction of the SSI absolute encoder can be reversed.

Table 1.1

SSI direction reversal setting	SSI absolute encoder output	ST1SS1		INC. LED	DEC. LED
		W _{r.n} Encoder value (Low),	W _{r.n+1} Encoder value (High)		
No reversal	Increment	Increment	Increment	ON	OFF
	Decrement	Decrement	Decrement	OFF	ON
Reversal	Increment	Decrement	Decrement	OFF	ON
	Decrement	Increment	Increment	ON	OFF

(9) Coincidence detection is available.

The ST1SS1 compares the present value with the coincidence detection value set in advance and, if these values are matched, it outputs a bit signal.

(10) Failure in DATA signal line is detectable.

The ST1SS1 can detect a failure that occurred on the DATA signal line connected to the SSI absolute encoder (e.g. disconnection, short circuit, incorrect wiring).

(11) Online module change

The module can be replaced without stopping the system.

(12) Easy setup using GX Configurator-ST

An optional software package (GX Configurator-ST) is separately available.

GX Configurator-ST is not necessarily required for system configuration.

However, use of GX Configurator-ST is recommended because parameter setting and automatic refresh setting can be configured on-screen, resulting in reduction of programming steps, and the setting/operating status can be easily checked.

CHAPTER2 SYSTEM CONFIGURATION

This chapter describes the system configuration for use of the ST1SS1.

2.1 Overall Configuration

The overall configuration for use of the ST1SS1 is shown below.

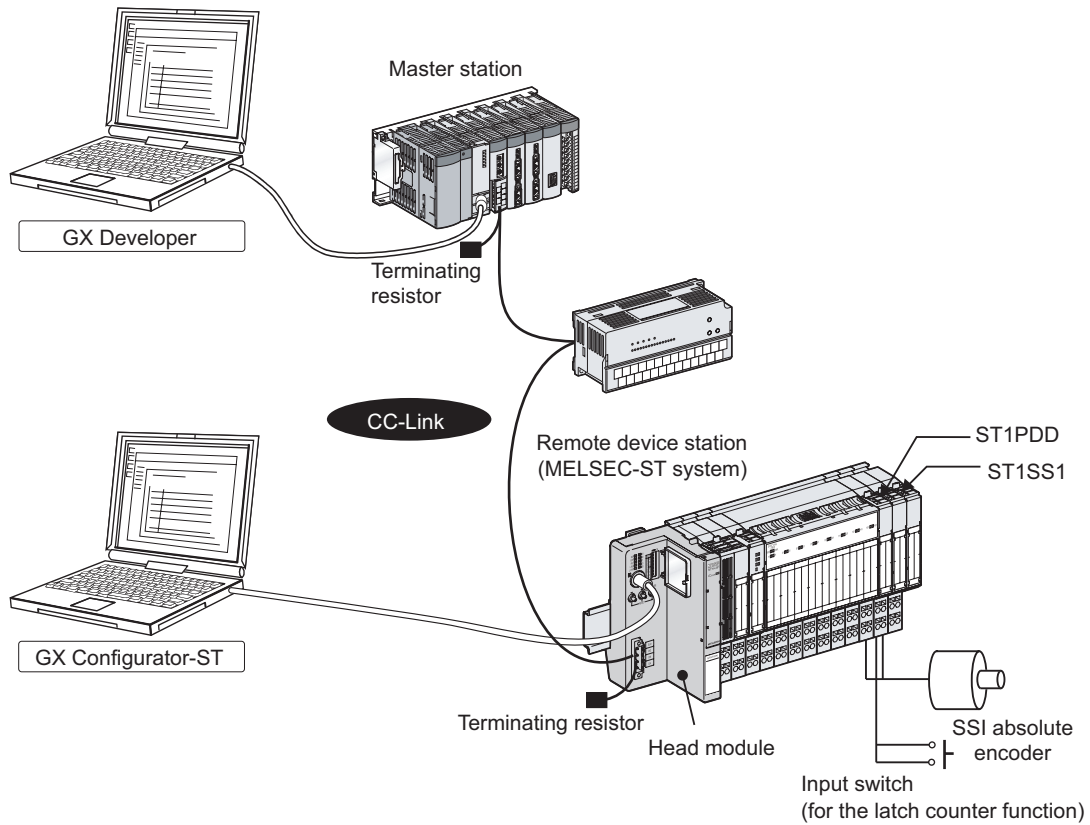

Figure 2.1 Overall system configuration

2.2 Applicable System

This section explains the applicable system.

2.2.1 Applicable head module

The head module applicable to the ST1SS1 is indicated below.

Table 2.1 Applicable head module

Product name	Model name
MELSECT-ST CC-Link Head Module	ST1H-BT

2.2.2 Applicable base module

The base modules applicable to the ST1SS1 are indicated below.

Table 2.2 Applicable base modules

Type	Model name
Spring Clamp Type	ST1B-S4IR2
Screw Clamp Type	ST1B-E4IR2

2.2.3 Applicable coding element

The coding element applicable to the ST1SS1 is indicated below.

The coding element is fitted before shipment.

It is also available separately in case it is lost.

Table 2.3 Applicable coding element

Product name	Model name
ST1SS1 coding element	ST1A-CKY-18

2.2.4 Applicable software package

The software package applicable to the ST1SS1 is indicated below.

Table 2.4 Applicable software package

Product name	Model name	Version
GX Configurator-ST ^{*1}	SW1D5C-STPB-E	1.06G or later

* 1 GX Configurator-ST is optional.

2.3 Precautions for System Configuration

When using the ST1SS1 in the MELSEC-ST system, pay attention to the following:

- 1) Mount a power distribution module on the immediate left of the ST1SS1. For details, refer to the following.
 Section 4.4.2 External wiring
- 2) When using multiple ST1SS1s, mount one power distribution module for each ST1SS1.
- 3) When installing the ST1SS1 together with another intelligent function module in the same power supply section, mount the ST1SS1 in the leftmost position of the power supply section.

For other precautions on the system configuration, refer to the following.

 MELSEC-ST System User's Manual, "3.4 Precautions for System Configuration".

CHAPTER3 SPECIFICATIONS

This chapter provides the specifications of the ST1SS1.
 For the general specifications of the ST1SS1, refer to the following.
 MELSEC-ST System User's Manual.

3.1 Performance Specifications

This section indicates the performance specifications of the ST1SS1.

(1) Performance specifications list

Table 3.1 Performance specifications list

Item		Specifications								
Number of input points		1 channel/module								
Output data format		Binary of up to 31 bits (0 to 2147483647)								
Applicable absolute encoder		Absolute encoder with SSI (Synchronous Serial Interface)								
Power voltage available for SSI absolute encoder		20.4V to 26.4V DC (Supplied through AUX. terminal of power distribution module.*1)								
Counting range		31-bit binary (0 to 2147483647)								
Resolution		2 to 31 bits (Can be set in 1-bit units)								
SSI baud rate		125kHz								
		250kHz								
		500kHz								
		1MHz								
		2MHz								
Transmission path*2		EIA standard RS-485								
Detection of input line error		Yes								
External input		1 point Rated input voltage : 24V DC (+20 / -15%, Ripple ratio: within 5%) Rated input current : Approx. 12mA								
ROM write count		Number of parameter setting writes to ROM: Up to 10,000 times								
Number of occupied I/O points		4 points for each of input and output								
Number of occupied slices		2								
Information amount	Input data	<input type="text" value="Br.n"/> : Number of occupancy 4, <input type="text" value="Wr.n"/> : Number of occupancy 2								
	Output data	<input type="text" value="Bw.n"/> : Number of occupancy 4, <input type="text" value="Ww.n"/> : Number of occupancy 0								
Isolation		<table border="1"> <thead> <tr> <th>Specific isolated area</th> <th>Isolation method</th> <th>Dielectric withstand</th> <th>Insulation resistance</th> </tr> </thead> <tbody> <tr> <td>Channels and internal bus</td> <td>Photocoupler</td> <td>510Vrms AC /1ms (elevation 2000m)</td> <td>500V DC 10MΩ or more</td> </tr> </tbody> </table>	Specific isolated area	Isolation method	Dielectric withstand	Insulation resistance	Channels and internal bus	Photocoupler	510Vrms AC /1ms (elevation 2000m)	500V DC 10MΩ or more
		Specific isolated area	Isolation method	Dielectric withstand	Insulation resistance					
Channels and internal bus	Photocoupler	510Vrms AC /1ms (elevation 2000m)	500V DC 10MΩ or more							
Applicable base module		Spring clamp type: ST1B-S4IR2 Screw clamp type: ST1B-E4IR2								
Applicable coding element		ST1A-CKY-18 (dark green)								
External AUX. power supply		24V DC (+20/-15%, ripple ratio within 5%) 24V DC current: 0.030A								
5V DC internal current consumption		0.080 A								
External dimensions		77.6 (3.06in.) (H) × 12.6 (0.50in.) (w) × 55.4 (2.18in.) (D) [mm]								
Weight		0.04 kg								

* 1 For the rated current of the AUX. terminal of the power distribution module, refer to the following.

 MELSEC-ST System User's Manual.

* 2 This is the case where the ST1SS1 is connected to an RS-485 type encoder (communication with the one equivalent to TI's SN75176 has been confirmed.) If any other type of encoder is connected, communication may be restricted.
 Be sure to check the specifications of the encoder to be connected.

3.1.1 Data update cycle of the ST1SS1

When the ST1SS1 sends a clock to an SSI absolute encoder, the encoder sends a positioning data back to the STSS1 in synchronization with the clock.

Data in ST1SS1's $Wr.n$ Encoder value (Low) and $Wr.n+1$ Encoder value (High) areas are updated regularly by communications with the SSI absolute encoder.

(1) Data update cycle of the ST1SS1

The ST1SS1 data update cycle varies depending on the SSI code length.

Shown below is a graph of the ST1SS1 data update cycle for the monoflop time of $96\mu s$.

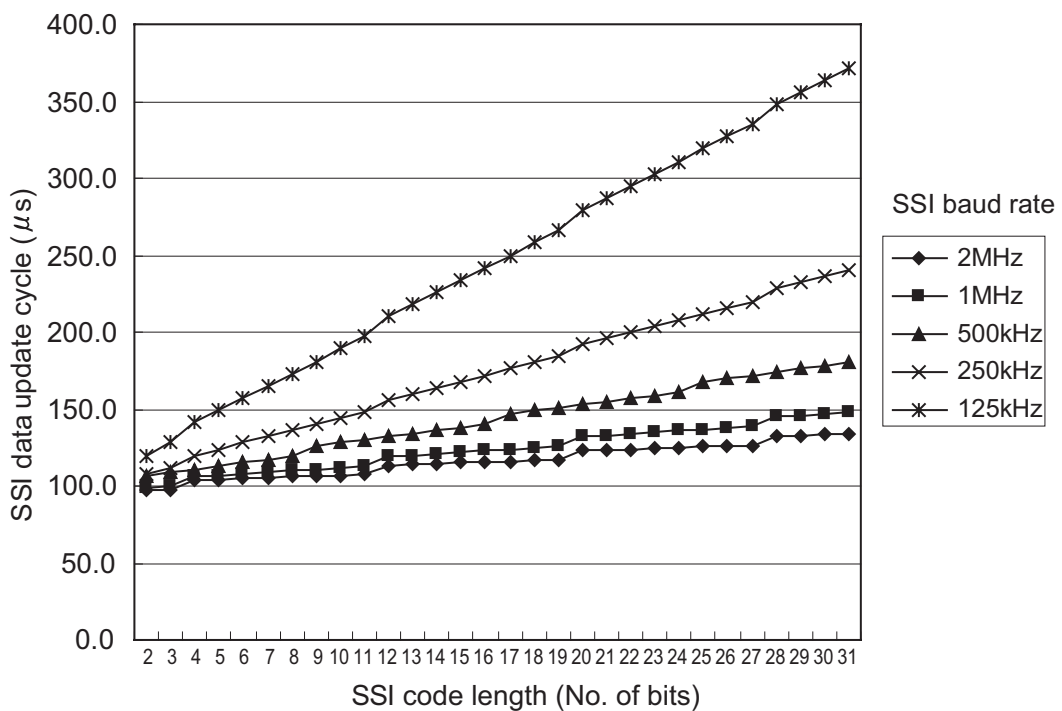

Figure 3.1 Data update cycle

The cycle for updating $Wr.n$ Encoder value (Low) and $Wr.n+1$ Encoder value (High) can be obtained from the formula shown below.

The formula varies depending on the SSI baud rate.

(a) When the SSI baud rate is 250kHz/1MHz/2MHz

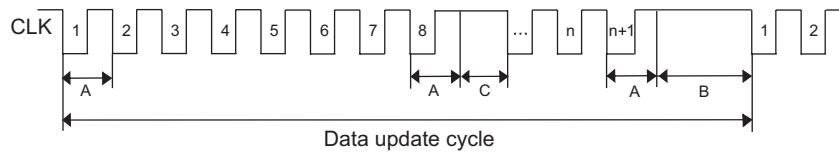

Figure 3.2 When the SSI baud rate is 250kHz/1MHz/2MHz

$$\text{Data update cycle} = A \times (n+1) + B + (C \times n/8)$$

A: Inverse of SSI baud rate, $f (1/f)$

n: SSI code length (☞ Section 3.2.1 Function list)

B: SSI monoflop time

(☞ Section 3.2.3 SSI monoflop time setting function)

C: Clock delay*1

250kHz: $4 \mu\text{s}$

1MHz: $5 \mu\text{s}$

2MHz: $5.5 \mu\text{s}$

Example) Calculation for: SSI baud rate: 250kHz, SSI code length: 25 bits, and

SSI monoflop time: $96 \mu\text{s}$

$$4 \times (25+1) + 96 + (4 \times 25/8) = 212.5 \mu\text{s}$$

(b) When the SSI baud rate is 125kHz/500kHz

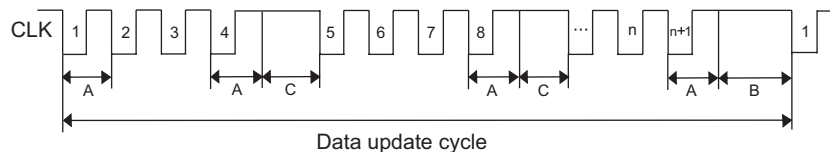

Figure 3.3 When the SSI baud rate is 125kHz/500kHz

$$\text{Data update cycle} = A \times (n+1) + B + (C \times n/4)$$

A: Inverse of SSI baud rate, $f (1/f)$

n: SSI code length (☞ Section 3.2.1 Function list)

B: SSI monoflop time

(☞ Section 3.2.3 SSI monoflop time setting function)

C: Clock delay*1

125kHz/500kHz: $5 \mu\text{s}$

Example) Calculation for: SSI baud rate: 125kHz, SSI code length: 25 bits, and

SSI monoflop time: $96 \mu\text{s}$

$$8 \times (25+1) + 96 + (5 \times 25/4) = 335.25 \mu\text{s}$$

* 1 Clock delay is the time of delay that occurs in communication with the SSI absolute encoder. The clock delay varies depending on the SSI baud rate.

1) When the SSI baud rate is 250kHz/1MHz/2MHz

The following clock delay occurs every 8 bits.

SSI baud rate of 250kHz: $4 \mu\text{s}$

SSI baud rate of 1MHz: $5 \mu\text{s}$

SSI baud rate of 2MHz: $5.5 \mu\text{s}$

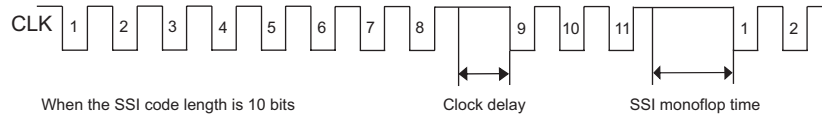

Figure 3.4 When the SSI baud rate is 250kHz/1MHz/2MHz

- 2) When the SSI baud rate is 125kHz/500kHz
 Clock delay of 5 μ s occurs every 4 bits.

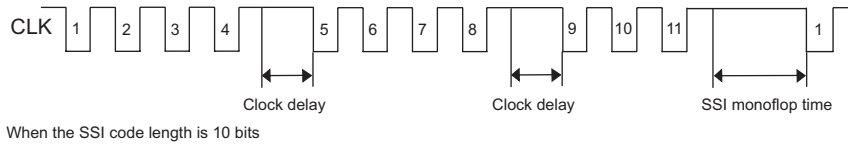

Figure 3.5 When the SSI baud rate is 125kHz/500kHz

3.1.2 Intelligent function module processing time

The intelligent function module processing time of the ST1SS1 is equal to the data update cycle.

For the input transmission delay time, refer to the following.

☞ MELSEC-ST CC-Link Head Module User's Manual

3.2 Functions

This section explains functions of the ST1SS1.

3.2.1 Function list

The following table lists functions of the ST1SS1.

Table 3.2 ST1SS1 Function List

Item	Description	Reference section
Counter function	<ol style="list-style-type: none"> The output data of the SSI absolute encoder are stored in the <input type="text" value="Wr.n"/> Encoder value (Low) and <input type="text" value="Wr.n+1"/> Encoder value (High) areas. Counting is available within the range from 0 to 2147483647 (31-bit binary). Counting is repeated within the range between the lower and upper limit values. 	Section 3.2.2
SSI code setting function (Gray code/Binary code selection)	<ol style="list-style-type: none"> Select either "Gray code" or "Binary code" for SSI code of the ST1SS1, in accordance with the SSI absolute encoder to be connected. The ST1SS1 always outputs binary data to a head module. (When "Gray code" is selected, it converts values into binary data and stores them in the <input type="text" value="Wr.n"/> Encoder value (Low) and <input type="text" value="Wr.n+1"/> Encoder value (High) areas.) The default is "Gray code". <p>[Setting method]</p> <ul style="list-style-type: none"> GX Configurator-ST (☞ Section 5.3 Parameter Setting) Dedicated instruction from the master station (RDMSG instruction) <ul style="list-style-type: none"> ☞ Section 8.3.1 Initial data batch write request (Command No.: 8106H) ☞ Section 8.3.2 Initial data individual write request (Command No.: 8107H/0107H) 	-
SSI baud rate selection function	<ol style="list-style-type: none"> Set the SSI baud rate applied to communication with the SSI absolute encoder. Select one from 125kHz, 250kHz, 500kHz, 1MHz, and 2MHz. The default is "125kHz". <p>[Setting method]</p> <ul style="list-style-type: none"> GX Configurator-ST (☞ Section 5.3 Parameter Setting) Dedicated instruction from the master station (RDMSG instruction) <ul style="list-style-type: none"> ☞ Section 8.3.1 Initial data batch write request (Command No.: 8106H) ☞ Section 8.3.2 Initial data individual write request (Command No.: 8107H/0107H) 	-
SSI code length setting function (Encoder resolution setting function)	<ol style="list-style-type: none"> Set an the SSI code length that matches resolution of the SSI absolute encoder. The ST1SS1 supports SSI absolute encoders with resolution of 2 to 31 bits. The setting range is 2 to 31 bits. The default is "25 bits". <p>[Setting method]</p> <ul style="list-style-type: none"> GX Configurator-ST (☞ Section 5.3 Parameter Setting) Dedicated instruction from the master station (RDMSG instruction) <ul style="list-style-type: none"> ☞ Section 8.3.1 Initial data batch write request (Command No.: 8106H) ☞ Section 8.3.2 Initial data individual write request (Command No.: 8107H/0107H) 	-

Table 3.2 ST1SS1 Function List (Continued)

Item	Description	Reference section
SSI parity setting function	<p>(1) Make the parity check setting (None, Even, or Odd) appropriate for the SSI absolute encoder.</p> <p>(2) Select any of "None", "Even", and "Odd".</p> <p>(3) When a parity error is detected, the ERR. LED turns on and the Error status (RXnA) is set to ON while <input type="checkbox"/>Wr.n Encoder value (Low) and <input type="checkbox"/>Wr.n+1 Encoder value (High) are retained.*1</p> <p>(4) The default is "None".</p> <p>[Setting method]</p> <ul style="list-style-type: none"> • GX Configurator-ST (☞ Section 5.3 Parameter Setting) • Dedicated instruction from the master station (RDMSG instruction) <ul style="list-style-type: none"> ☞ Section 8.3.1 Initial data batch write request (Command No.: 8106H) ☞ Section 8.3.2 Initial data individual write request (Command No.: 8107H/0107H) 	-
SSI monoflop time setting function	<p>(1) Set the time to be reserved for synchronization with the data update cycles of the SSI absolute encoder (SSI monoflop time).</p> <p>(2) Select one from 48μs, 64μs, 80μs and 96μs.</p> <p>(3) The default is "96μs".</p> <p>[Setting method]</p> <ul style="list-style-type: none"> • GX Configurator-ST (☞ Section 5.3 Parameter Setting) • Dedicated instruction from the master station (RDMSG instruction) <ul style="list-style-type: none"> ☞ Section 8.5.2 SSI monoflop time setting write (Command No.: A502H/2502H) 	Section 3.2.3
Latch counter function	<p>(1) The ST1SS1 has 1-point digital input for the latch function and, if a signal is input from the input switch, it latches the values stored in <input type="checkbox"/>Wr.n Encoder value (Low) and <input type="checkbox"/>Wr.n+1 Encoder value (High) and turns ON (1) <input type="checkbox"/>Br.n+2 Latch detection flag.</p> <p>(2) Select a desired option from "No latch", "Rising edge", "Falling edge", and "Rising + falling edge".</p> <p>(3) To clear <input type="checkbox"/>Br.n+2 Latch detection flag, set <input type="checkbox"/>Bw.n+2 Latch detection clear request to ON (1).</p> <p>(4) The default is "No latch".</p> <p>[Setting method]</p> <ul style="list-style-type: none"> • GX Configurator-ST (☞ Section 5.3 Parameter Setting) • Dedicated instruction from the master station (RDMSG instruction) <ul style="list-style-type: none"> ☞ Section 8.5.3 Latch mode setting write (Command No.: A503H/2503H) 	Section 3.2.4
Detection of rotational direction	<p>(1) The ST1SS1 has two LEDs that indicate rotational directions of the SSI absolute encoder, so that its incrementing or decrementing count can be confirmed with the corresponding LED.</p>	-

Table 3.2 ST1SS1 Function List (Continued)

Item	Description	Reference section																												
SSI direction reversal setting	<p>(1) Incrementing or decrementing count relative to the rotational direction of the SSI absolute encoder can be reversed.</p> <p>(2) Select either "No reversal" or "Reversal".</p> <table border="1" data-bbox="427 430 1225 743"> <thead> <tr> <th rowspan="2">SSI direction reversal setting</th> <th rowspan="2">SSI absolute encoder output</th> <th colspan="2">ST1SS1</th> <th rowspan="2">INC. LED</th> <th rowspan="2">DEC. LED</th> </tr> <tr> <th>Wr.n Encoder value (Low), Wr.n+1 Encoder value (High)</th> <th></th> <th></th> <th></th> </tr> </thead> <tbody> <tr> <td rowspan="2">No reversal</td> <td>Increment</td> <td>Increment</td> <td>ON</td> <td>OFF</td> </tr> <tr> <td>Decrement</td> <td>Decrement</td> <td>OFF</td> <td>ON</td> </tr> <tr> <td rowspan="2">Reversal</td> <td>Increment</td> <td>Decrement</td> <td>OFF</td> <td>ON</td> </tr> <tr> <td>Decrement</td> <td>Increment</td> <td>ON</td> <td>OFF</td> </tr> </tbody> </table> <p>(3) The default is "No reversal". [Setting method]</p> <ul style="list-style-type: none"> • GX Configurator-ST (☞ Section 5.3 Parameter Setting) • Dedicated instruction from the master station (RDMSG instruction) <ul style="list-style-type: none"> ☞ Section 8.3.1 Initial data batch write request (Command No.: 8106H) ☞ Section 8.3.2 Initial data individual write request (Command No.: 8107H/0107H) 	SSI direction reversal setting	SSI absolute encoder output	ST1SS1		INC. LED	DEC. LED	Wr.n Encoder value (Low), Wr.n+1 Encoder value (High)				No reversal	Increment	Increment	ON	OFF	Decrement	Decrement	OFF	ON	Reversal	Increment	Decrement	OFF	ON	Decrement	Increment	ON	OFF	
SSI direction reversal setting	SSI absolute encoder output			ST1SS1				INC. LED	DEC. LED																					
		Wr.n Encoder value (Low), Wr.n+1 Encoder value (High)																												
No reversal	Increment	Increment	ON	OFF																										
	Decrement	Decrement	OFF	ON																										
Reversal	Increment	Decrement	OFF	ON																										
	Decrement	Increment	ON	OFF																										
Coincidence detection function	<p>(1) The preset coincidence detection value (command parameter) is compared with Wr.n Encoder value (Low) and Wr.n+1 Encoder value (High). If these values are matched, Br.n+3 Coincidence detection flag turns ON (1).</p> <p>(2) In the coincidence detection flag setting, select a desired option from "No comparator", "Upward", "Downward" or "Upward + downward". The default is "No comparator".</p> <p>(3) The coincidence detection setting value can be set within the range from 0 to 2147483647 in 1-point units. The default is "0".</p> <p>(4) To clear Br.n+3 Coincidence detection flag, set Bw.n+3 Comparator clear request to ON (1).</p> <p>[Coincidence detection flag setting method]</p> <ul style="list-style-type: none"> • GX Configurator-ST (☞ Section 5.3 Parameter Setting) • Dedicated instruction from the master station (RDMSG instruction) <ul style="list-style-type: none"> ☞ Section 8.5.4 Coincidence detection flag setting write (Command No.: A504H/2504H) <p>[Coincidence detection value setting method]</p> <ul style="list-style-type: none"> • GX Configurator-ST (☞ Section 5.3 Parameter Setting) • Dedicated instruction from the master station (RDMSG instruction) <ul style="list-style-type: none"> ☞ Section 8.5.5 Coincidence detection value write (Command No.: A505H/2505H) 	Section 3.2.5																												
SSI trailing bits setting function	<p>(1) Set the number of trailing bits if the SSI absolute encoder connected has trailing bits.</p> <p>(2) The setting range is 0 to 15 bits.</p> <p>(3) The default is "0" bits.</p> <p>[Setting method]</p> <ul style="list-style-type: none"> • GX Configurator-ST (☞ Section 5.3 Parameter Setting) • Dedicated instruction from the master station (RDMSG instruction) <ul style="list-style-type: none"> ☞ Section 8.5.1 SSI trailing bits setting write (Command No.: A501H/2501H) 																													
DATA signal line error detection function	<p>(1) The ST1SS1 can detect a failure occurred on the DATA signal line connected to the SSI absolute encoder (e.g. disconnection, short circuit, incorrect wiring).</p> <p>(2) Upon detection of a DATA signal line error, the ERR. LED turns on and the Error status (RXnA) is set to ON while Wr.n Encoder value (Low) and Wr.n+1 Encoder value (High) are retained.*1</p>																													

1	OVERVIEW
2	SYSTEM CONFIGURATION
3	SPECIFICATIONS
4	SETUP AND PROCEDURES BEFORE OPERATION
5	GX Configurator-ST
6	PROGRAMMING
7	ONLINE MODULE CHANGE
8	COMMANDS

Table 3.2 ST1SS1 Function List (Continued)

Item	Description	Reference section
Command	(1) By using commands, command parameters can be set, and the parameter settings can be written from RAM to ROM and read from ROM to RAM.	CHAPTER 8
Online module change	(1) A module can be replaced without the system being stopped. [Execution procedure] • GX Configurator-ST • Button operation on the head module	CHAPTER 7

* 1 Error status (RXnA) is a remote input of the head module.

When Error status (RXnA) is ON, the error module can be identified by executing the Error module information read request command (command No.: 0103H).

In order to obtain the error code, execute the Error code read request command (command No.: 8101H/0101H) to the identified error module.

Take corrective actions to correct the error, refer to the following:

 Section 9.1 Error Code List

For details of the Error status (RXnA), refer to the following.

 MELSEC-ST CC-Link Head Module User's Manual, "3.4 Remote I/O, Remote Registers"

3.2.2 Counter function

- (1) The output data of the SSI absolute encoder are stored in the $Wr.n$ Encoder value (Low) and $Wr.n+1$ Encoder value (High) areas.
- (2) Counting is available within the range from 0 to 2147483647 (31-bit binary).
- (3) Counting is repeated within the range between the lower limit (0) and upper limit (different depending on the SSI code length setting) values.

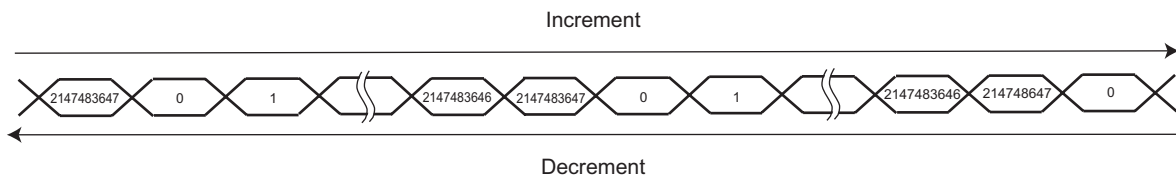

Figure 3.6 Counter function

- (4) At power-up of the MELSEC-ST system, at reset of the head module, or when $Bw.n+1$ Convert setting request turns OFF (0), 0 is stored.

3.2.3 SSI monoflop time setting function

- (1) **The SSI monoflop time (T_p) is a time to be reserved for synchronization with the data update cycles of an SSI absolute encoder.**

To communicate with the SSI absolute encoder, set the SSI monoflop time (T_p) to allow time for data transmission of the encoder to be reset (T_m) under a condition of $T_p > T_m$.

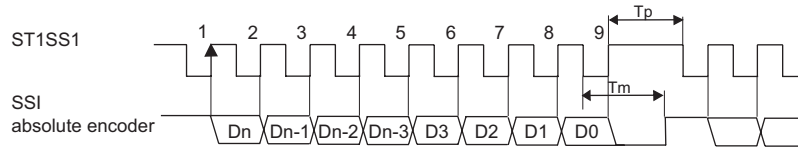

Figure 3.7 SSI monoflop time setting function

- (2) **Select one from 48 μ s, 64 μ s, 80 μ s and 96 μ s.**

When the SSI baud rate is 125kHz or 250kHz, there are restrictions on the SSI monoflop time setting.

For the case of 500kHz, 1MHz, or 2MHz, there are no restrictions.

Figure 3.8 Restrictions on the SSI monoflop time setting

SSI baud rate	SSI monoflop time setting			
	48 μ s	64 μ s	80 μ s	96 μ s
125kHz	×			○
250kHz	×			○
500kHz			○	
1MHz			○	
2MHz			○	

○: Can be set ×: Can not be set

- (3) **The default is 96 μ s.**

3.2.4 Latch counter function

- (1) The ST1SS1 has 1-point digital input for the latch function and, if a signal is input from an input switch, it latches the values stored in $Wr.n$ Encoder value (Low) and $Wr.n+1$ Encoder value (High) and turns ON (1) $Br.n+2$ Latch detection flag.
- (2) Select a desired option from "No latch", "Rising edge", "Falling edge", and "Rising + falling edge".
- (3) To clear $Br.n+2$ Latch detection flag, set $Bw.n+2$ Latch detection clear request to ON (1).
- (4) While $Br.n+2$ Latch detection flag is OFF (0), $Wr.n$ Encoder value (Low) and $Wr.n+1$ Encoder value (High) are constantly updated to the latest values.
- (5) The figure below shows the relation between the SSI absolute encoder output, the digital input signal, and $Wr.n$ Encoder value (Low) and $Wr.n+1$ Encoder value (High) in the latch counter function (Latch mode setting: Rising edge).

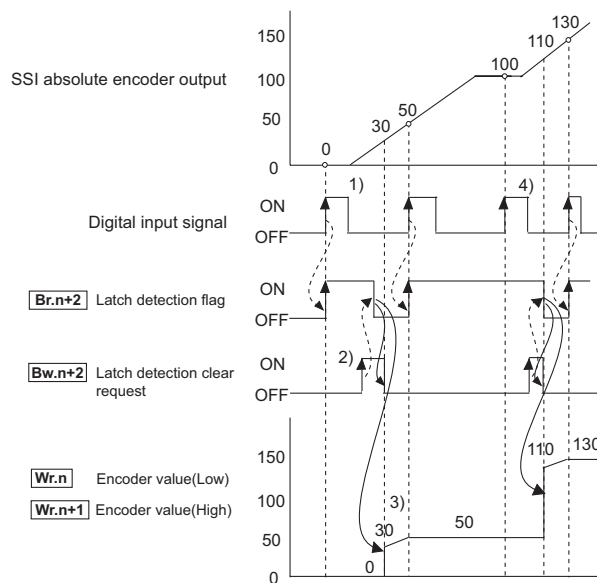

Figure 3.9 Latch counter function

- 1) $Br.n+2$ Latch detection flag turns ON (1) at the rise of the digital input signal, and $Wr.n$ Encoder value (Low) and $Wr.n+1$ Encoder value (High) are latched.
- 2) When $Br.n+2$ Latch detection clear request is set to ON (1), $Br.n+2$ Latch detection flag turns OFF (0).
- 3) While $Br.n+2$ Latch detection flag is OFF (0), $Wr.n$ Encoder value (Low) and $Wr.n+1$ Encoder value (High) are constantly updated to the latest values.
- 4) Even if the digital input signal rises with $Br.n+2$ Latch detection flag set to ON (1), $Wr.n$ Encoder value (Low) and $Wr.n+1$ Encoder value (High) are not updated.

3.2.5 Coincidence detection function

(1) The preset coincidence detection value (command parameter) is compared with $Wr.n$ Encoder value (Low) and $Wr.n+1$ Encoder value (High).

If these values are matched, $Br.n+3$ Coincidence detection flag turns ON (1).

(2) In the coincidence detection flag setting, select a desired option from "No comparator", "Upward", "Downward" or "Upward + downward". Conditions for detection on each setting are given in the table below.

Table 3.3 Coincidence detection function

Coincidence detection flag setting	Conditions for detection
Upward	$Wr.n$ Encoder value (Low) and $Wr.n+1$ Encoder value (High) match the Coincidence detection value while they are incremented.
Downward	$Wr.n$ Encoder value (Low) and $Wr.n+1$ Encoder value (High) match the Coincidence detection value while they are decremented.
Upward + downward	$Wr.n$ Encoder value (Low) and $Wr.n+1$ Encoder value (High) match the Coincidence detection value regardless of whether they are incremented or decremented.

(3) The coincidence detection setting value can be set within the range from 0 to 2147483647 in 1-point units.

(4) To clear $Br.n+3$ Coincidence detection flag, set $Bw.n+3$ Comparator clear request to ON (1).

(5) The following diagram shows the relation between $Wr.n$ Encoder value (Low), $Wr.n+1$ Encoder value (High) and $Br.n+3$ Coincidence detection flag in the coincidence detection function.

(a) Example 1) Coincidence detection flag setting: Upward, Coincidence detection value: 1000

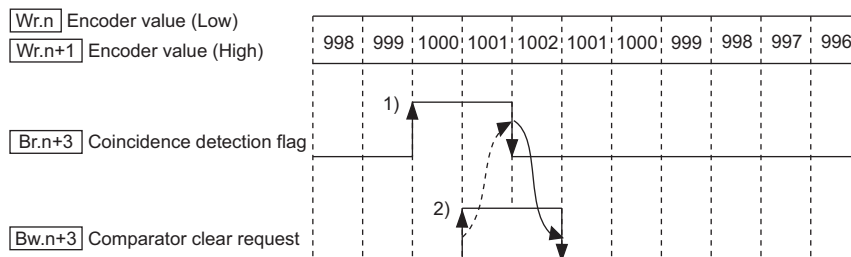

Figure 3.10 Coincidence detection function (example 1)

1) When $Wr.n$ Encoder value (Low) and $Wr.n+1$ Encoder value (High) match the Coincidence detection value while they are incremented, $Br.n+3$ Coincidence detection flag turns ON (1).

- 2) When Br.n+3 Comparator clear request is set to ON (1), Br.n+3 Coincidence detection flag is set to OFF (0).

(b) Example 2) Coincidence detection flag setting: Downward, Coincidence detection value: 1000

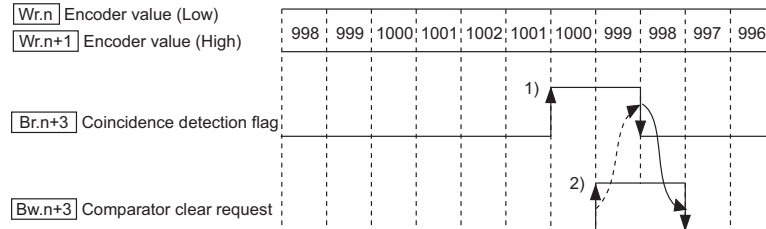

Figure 3.11 Coincidence detection function (example 2)

- 1) When Wr.n Encoder value (Low) and Wr.n+1 Encoder value (High) match the Coincidence detection value while they are decremented, Br.n+3 Coincidence detection flag turns ON (1).
- 2) When Br.n+3 Comparator clear request is set to ON (1), Br.n+3 Coincidence detection flag is set to OFF (0).

(c) Example 3) Coincidence detection flag setting: Upward + downward, Coincidence detection value: 1000

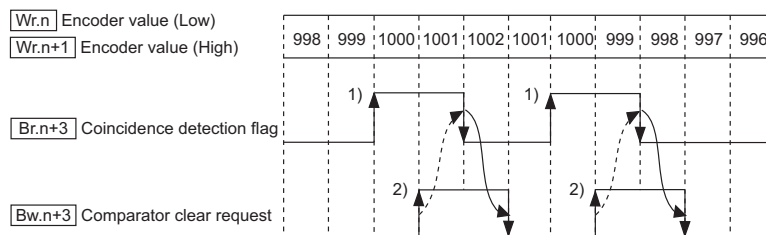

Figure 3.12 Coincidence detection function (example 3)

- 1) When Wr.n Encoder value (Low) and Wr.n+1 Encoder value (High) match the Coincidence detection value regardless of whether they are incremented or decremented, Br.n+3 Coincidence detection flag turns ON (1).
- 2) When Bw.n+3 Comparator clear request is set to ON (1), Br.n+3 Coincidence detection flag is set to OFF (0).

(6) The coincidence detection function compares the present values of Wr.n Encoder value (Low) and Wr.n+1 Encoder value (High) with the previous ones.

When the encoder value changes from the upper limit to the lower limit or from the lower limit to the upper limit, the Coincidence detection flag turns ON (1) even if the direction of value change is opposite to the setting.

Example) Coincidence detection flag setting: Upward, Coincidence detection value: 1000, SSI code length setting: 16 bits

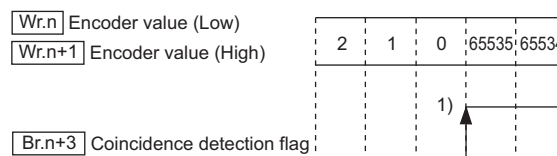

Figure 3.13 Coincidence detection function

- 1) When the value is changed from the lower limit (0) to the upper limit (65535) in the decrement setting, the ST1SS1 identifies it as an increase from 0 to 65535 and turns ON (1) the Coincidence detection flag.

3.3 I/O Data

The ST1SS1 has the areas for data transfer with the head module as indicated below. This section explains the composition of each area.

Table 3.4 I/O data list

Transfer direction	Item	Number of Occupancy	Default value	Reference section
ST1SS1 → Head module (Input Data)	Br Bit Input Area	4	0	Section 3.3.1
	Wr Word Input Area	2	0	Section 3.3.2
Head module → ST1SS1 (Output Data)	Bw Bit Output Area	4	0	Section 3.3.3
	Ww Word Output Area	0	0	-

3.3.1 Bit input area

This section explains the **Br** Bit input area.

(1) "Br.n" Module READY

(a) This turns ON (1) when the MELSEC-ST system (ST1SS1) is powered up or when the head module is reset.

(b) While **Br.n** Module READY is OFF (0), counting is not performed.

Br.n Module READY turns OFF (0) when:

- A watchdog timer error occurred.
- The system is in module-replaceable status during online module change.

(☞ CHAPTER 7 ONLINE MODULE CHANGE.)

(2) "Br.n+1" Convert setting completed flag

(a) When command parameter setting check is completed, this will turn ON (1) after **Bw.n+1** Convert setting request turned ON (1). (This will also turn ON (1) if a setting error is detected.)

[When parameter setting is normal]

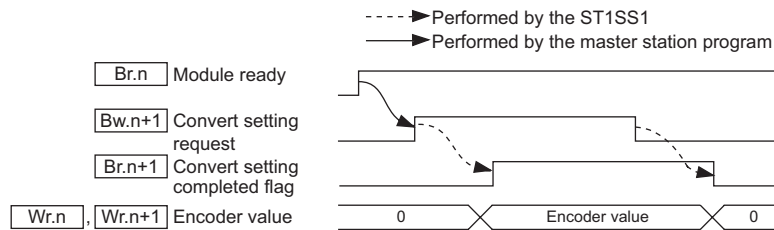

Figure 3.14 When parameter setting is normal

[When parameter setting is not normal]

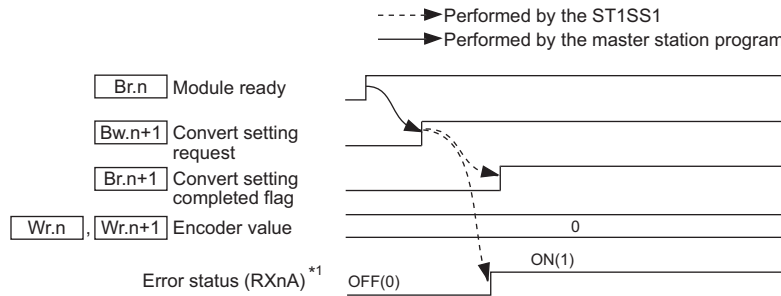

Figure 3.15 When parameter setting is not normal

* 1 Error status (RXnA) is a remote input of the head module.

When Error status (RXnA) is ON, the error module can be identified by executing the Error module information read request command (command No.: 0103H).

In order to obtain the error code, execute the Error code read request command (command No.: 8101H/0101H) to the identified error module.

Take corrective actions to correct the error, refer to the following:

☞ Section 9.1 Error Code List

For details of Error status (RXnA), refer to the following.

☞ MELSEC-ST CC-Link Head Module User's Manual, "3.4 Remote I/O, Remote Registers"

(3) "Br.n+2" Latch detection flag

- (a) When a latch signal is detected, this flag will turn ON (1) after the encoder values are stored and latched in Wr.n Encoder value (Low) and Wr.n+1 Encoder value (High). This flag turns ON (1) when a signal is input by the digital input for latch and its values are stored and latched in Wr.n Encoder value (Low) and Wr.n+1 Encoder value (High).

(4) "Br.n+3" Coincidence detection flag

- (a) Wr.n Encoder value (Low) and Wr.n+1 Encoder value (High) are compared with the preset coincidence detection value (command parameter), and if they match each other, this flag turns ON (1).

3.3.2 Word input area

This section explains the Wr word input area.

(1) "Wr.n" Encoder value (Low)

- (a) The low order word of the encode data (bit 0 to 15) is stored.

(2) "Wr.n+1" Encoder value (High)

- (a) The high order word of the encode data (bit 16 to 31) is stored.

3.3.3 Bit output area

This section explains the $\boxed{\text{Bw}}$ bit output area.

(1) "Bw.n" System area

Use of this area is prohibited. (Fixed to 0)

(2) "Bw.n+1" Convert setting request

(a) Set this to ON (1) to start converting the values from the SSI absolute encoder.

And to stop the conversion, set this to OFF (0).

- OFF (0): Conversion stop (Default)
- ON (1): Conversion start

(b) Turn this from OFF (0) to ON (1) to enable the settings of the command parameters.

1) When writing command parameters, set $\boxed{\text{Bw.n+1}}$ Convert setting request to OFF (0) to stop the conversion.

In the ON (1) status, the command parameters cannot be written.

(c) For the ON (1)/OFF (0) timing, refer to the following.

☞ Section 3.3.1 (2) "Br.n+1" Convert setting completed flag

(3) "Bw.n+2" Latch detection clear request

(a) To turn off $\boxed{\text{Br.n+2}}$ Latch detection flag, set this request bit from OFF (0) to ON (1).

(b) After confirming that $\boxed{\text{Br.n+2}}$ Latch detection flag has turned to OFF (0), set this request bit back to OFF (0) again.

OFF(0): No latch detection clear request (Default)

ON(1) : Latch detection clear requested

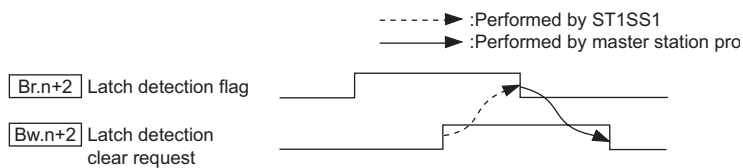

Figure 3.16 "Bw.n+2" Latch detection clear request

(4) "Bw.n+3" Comparator clear request

(a) To turn off $\boxed{\text{Br.n+3}}$ Coincidence detection flag, set this request bit from OFF (0) to ON (1).

(b) After confirming that **Br.n+3** Coincidence detected flag has turned to OFF (0), set this request bit back to OFF (0) again.

OFF (0): No coincidence detection clear request (Default)

ON (1) : Coincidence detection clear requested

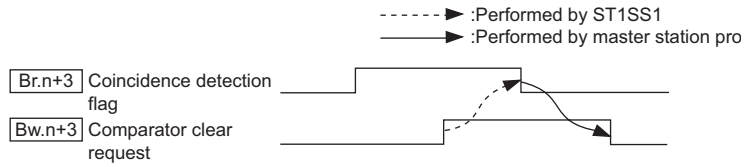

Figure 3.17 "Bw.n+3" Comparator clear request

3.4 Memory and Parameters

This section explains the memory and parameters of the ST1SS1.

3.4.1 Memory

RAM and ROM can be used to store the parameter of ST1SS1.

(1) RAM

- (a) The ST1SS1 operates based on the parameter settings stored in the RAM.
- (b) The parameter settings stored in the RAM become valid when the Bw.n+1 convert setting request turns from OFF to ON.

(2) ROM

- (a) The parameters stored in the ROM are not erased even if the power is turned off.
- (b) The parameters stored in the ROM are transferred to the RAM when:
 - The MELSEC-ST system (ST1SS1) is powered off, then on.
 - The head module is reset.
 - Parameter setting read from ROM command (command number: B500H/3500H) is executed.

3.4.2 Parameters

The setting items required to operate the ST1SS1 are called command parameters.

(1) Setting command parameters

Use either of the following methods to set command parameters.

(a) GX Configurator-ST

GX Configurator-ST allows easy on-screen setup, reducing programming steps on the master station.

If the set values should be used every time when the MELSEC-ST system starts up, they must be written to the ROM. (Writing the set values to the RAM is used only for temporary testing.)

(b) Command

- 1) Using the dedicated instruction (RDMSG) of the master station to execute a command, setting values can be written to RAM of the ST1SS1.
- 2) Then, using command "Parameter setting write to ROM" (command No.: B501H/3501H), the setting value stored in RAM can be written to the ROM
- 3) Writing command parameters to ROM in advance can reduce programming steps in the sequence program.

(2) Command parameter list

Command parameters and corresponding command numbers are listed below.

The following command parameters can be set in GX Configurator-ST.

Table 3.5 Command parameter list

Setting item	Command
SSI baud rate setting	
SSI direction reversal setting	8106H
SSI code setting	8107H/0107H
SSI code length setting	
SSI parity setting	
SSI trailing bits setting	A501H/2501H
SSI monoflop time setting	A502H/2502H
Latch mode setting	A503H/2503H
Coincidence detection flag setting	A504H/2504H
Coincidence detection value setting	A505H/2505H

POINT

For commands with the number 8000H and greater, determine the head module and slice modules with their slice position numbers.

And for commands with the number 7FFFH and lower, determine them with their start slice numbers.

CHAPTER4 SETUP AND PROCEDURES BEFORE OPERATION

4.1 Handling Precautions

- (1) **Do not drop the module or give it hard impact since its case is made of resin.
Doing so can damage the module.**
- (2) **Do not disassemble or modify the modules.
Doing so could cause failure, malfunction, injury or fire.**
- (3) **Be careful not to let foreign particles such as swarf or wire chips enter the module.
They may cause a fire, mechanical failure or malfunction.**

4.2 Setup and Procedure before Operation

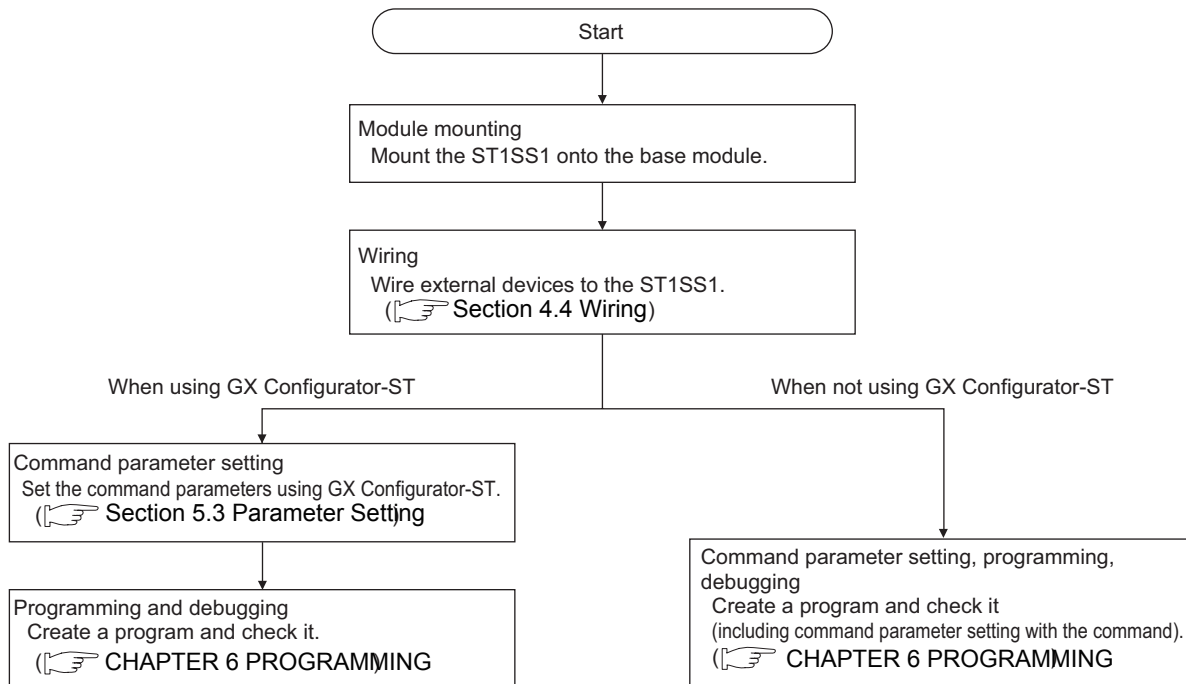

Figure 4.1 Setup and procedure before operation

4.3 Part Names

The name of each part of the ST1SS1 is listed below.

The following shows the ST1SS1 mounted on the spring clamp type base module.

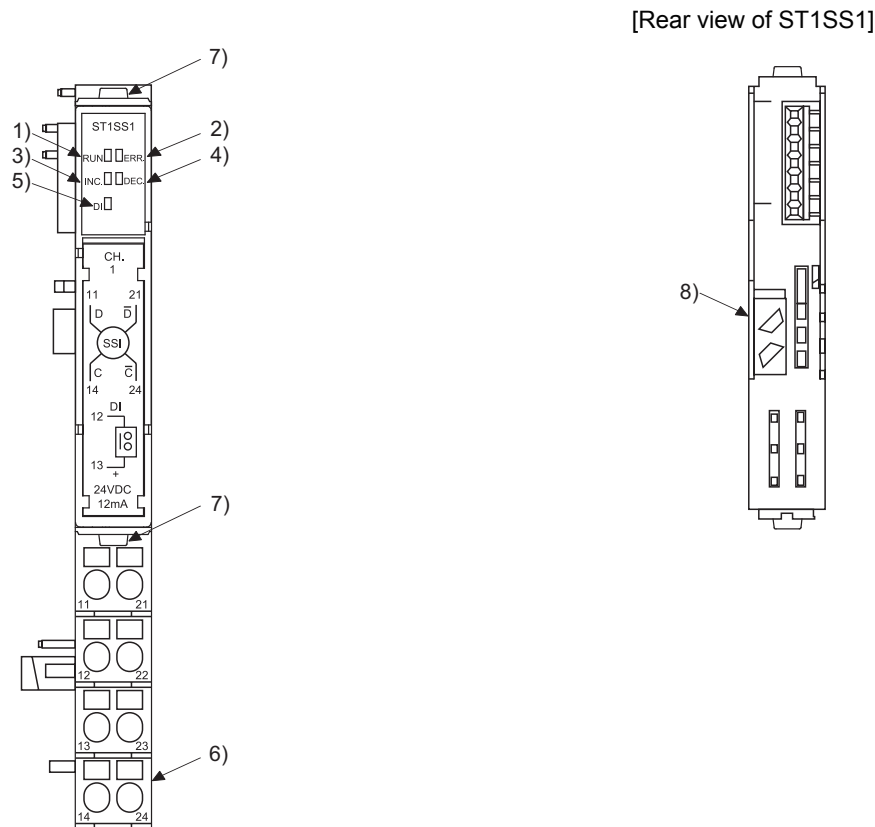

Figure 4.2 Part names

Table 4.1 Parts and descriptions

No.	Item	Description
1)	RUN LED	The RUN and ERR. LEDs (on/flashing/off) indicate various states of the ST1SS1.
2)	ERR. LED	(☞ Section 4.3.1 (1) Indications of RUN and ERR. LEDs)
3)	INC. LED	The lighting status of the INC. and DEC. LEDs indicates the rotational direction of the SSI absolute encoder.
4)	DEC. LED	(☞ Section 4.3.1 (2) Indications of INC. and DEC. LEDs)
5)	DI LED	This LED indicates the status of digital input that is used for the latch counter function. ON: Digital input ON OFF: Digital input OFF
6)	Terminal block	Wires are connected between the ST1SS1 and the terminal block of the base module for the ST1SS1/ST1PSD/ST1PDD. For base modules applicable to the ST1PSD/ST1PDD, refer to the following. ☞ MELSEC-ST System User's Manual. [Applicable base modules for ST1SS1] Spring Clamp Type: ST1B-S4IR2 Screw Clamp Type: ST1B-E4IR2
7)	Slice module fixing hooks (at both ends)	Used for mounting/dismounting the ST1SS1 to/from the base module. While pressing the hooks at both ends, mount/dismount the ST1SS1.

Table 4.1 Parts and descriptions

No.	Item	Description
8)	Coding element	<p>Prevents the module from being mounted incorrectly.</p> <p>The coding element consists of two pieces, and its shape varies depending on the model name.</p> <p>When the ST1SS1 is mounted on the base module and then dismantled, one piece of the coding element remains on the base module, and the other remains on the ST1SS1.</p> <p>The ST1SS1 can be mounted onto the base module only when the two pieces of the coding elements are matched.</p> <p>[Applicable coding element] ST1A-CKY-18</p>

POINT

In order to ensure safety, make sure to attach the coding element to the base module and ST1SS1.

Table 4.2 Terminal number assignment

Terminal No.	Signal name	Terminal No.	Signal name
11	DATA	21	$\overline{\text{DATA}}$
12	DI	22	DI
13	+24V	23	+24V
14	CLK	24	$\overline{\text{CLK}}$

4.3.1 Status confirmation by LEDs

The LED indications are described here.

(1) Indications of RUN and ERR. LEDs

Indications of the RUN and ERR. LEDs are shown below.

Table 4.3 LED Indications

LED indication		Operating status
RUN LED	ERR. LED	
On	Off	Normal
	On	System error occurred
Flashing (1s interval)	Off	Data communication stop or parameter error between the master station and head module, another slice module fault, or internal bus error
	On	System error occurred during data communication stop, a parameter error between the master station and head module, another slice module fault, or internal bus error
Flashing (0.25s interval)	Off	Module is selected as the target of online module change.
	On	System error occurred when module is selected as the target of online module change.
Off	Off	Power is off or online module change is in execution.
	On	System error occurred during online module change

(2) Indications of INC. and DEC. LEDs

Indications of the INC. and DEC. LEDs are shown below.

LED indication		Operating status
INC. LED	DEC. LED	
Off	Off	The SSI absolute encoder output is not changing.
On	Off	The SSI absolute encoder output is being incremented.
		(When the Direction reversal setting (command parameter) is set to "Reversal", the SSI absolute encoder output is being decremented.)
Off	On	The SSI absolute encoder output is being decremented.
		(When the Direction reversal setting (command parameter) is set to "Reversal", the SSI absolute encoder output is being incremented.)

POINT

When the encoder value is changed from the upper limit to the lower limit or from the lower limit to the upper limit, the INC. or DEC. LED showing direction opposite to the SSI absolute encoder rotation turns on instantaneously.

4.4 Wiring

The wiring precautions and examples of module connection are provided in this section.

4.4.1 Wiring precautions

In order to optimize the functions of the ST1SS1 and ensure system reliability, external wiring must be protected from noise.

Please observe the following precautions for external wiring:

- (1) **Use separate cables for the AC control circuit and the external input signals of the ST1SS1 to avoid the influence of the AC side surges and inductions.**
- (2) **Do not install the cables together with the main circuit line, a high-voltage cable or a load cable running from other than the MELSEC-ST system. Doing so may increase the effects of noise, surges and induction.**
- (3) **Always place the SSI absolute encoder signal cable at least 100mm (3.94inch) away from the main circuit cables and AC control lines.**
- (4) **Fully keep it away from high-voltage cables and circuits which include harmonics, such as an inverter's load circuit.
Not doing so will make the module more susceptible to noises, surges and inductions.**

4.4.2 External wiring

Connect the SSI absolute encoder to the ST1SS1 and ST1PSD/ST1PDD with cables.
Mount the ST1PSD/ST1PDD on the immediate left of the ST1SS1.
Connect the cables to the base module (sold separately).
For wiring details on the ST1PSD/ST1PDD, refer to the following.

☞ MELSEC-ST System User's Manual

(1) When the ST1PSD is placed on the left.

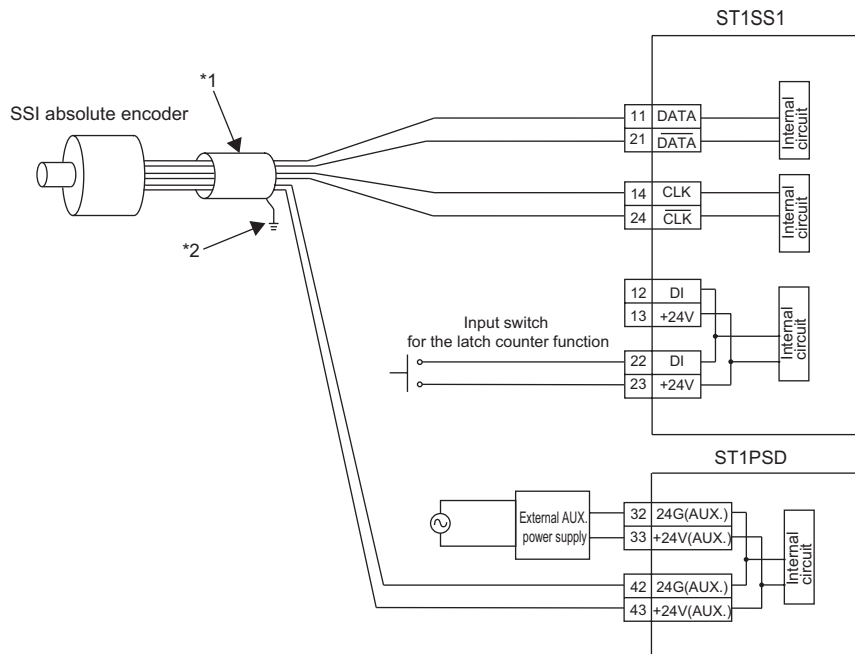

Figure 4.3 When the ST1PD is placed on the left

- * 1 Be sure to use a shielded twisted pair cable.
Also, use the shielded wire as short as possible.
- * 2 Ground the shield through the cable clamp or terminal block.
Depending on noise conditions, however, it is recommended to ground the shield on the external device side.

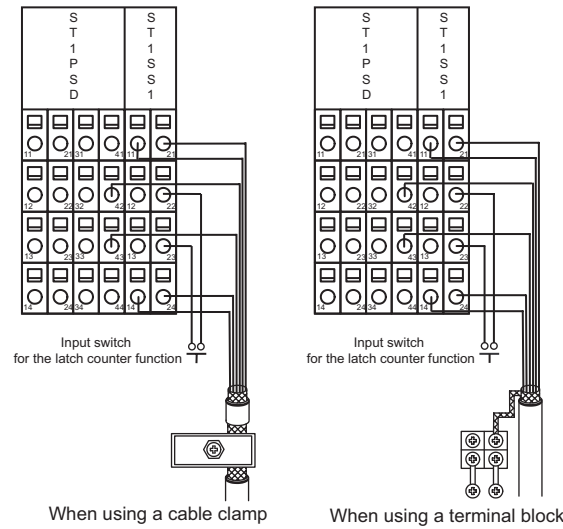

Figure 4.4 When using a cable clamp or a terminal block

(2) When the ST1PDD is placed on the left

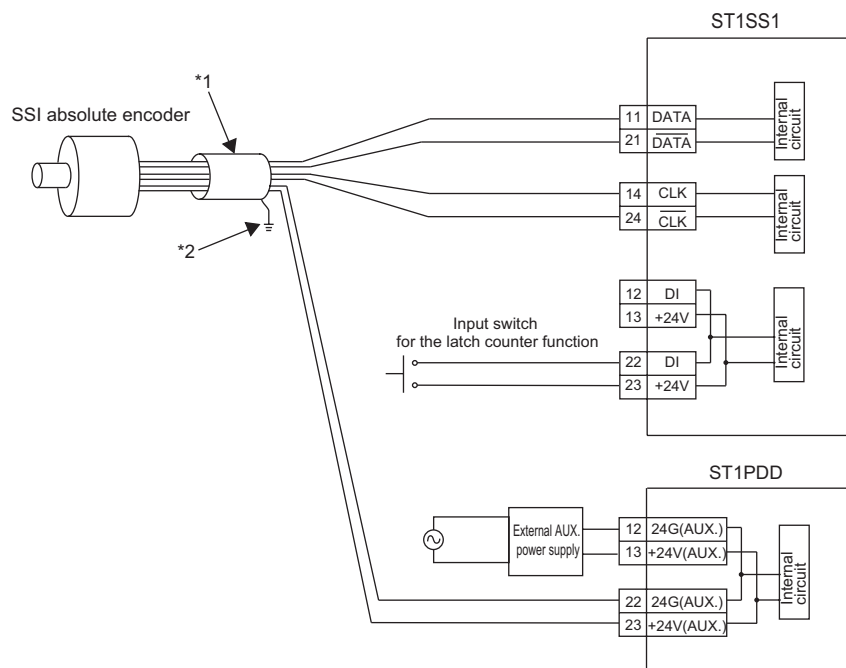

Figure 4.5 When the ST1PDD is placed on the left

- * 1 Be sure to use a shielded twisted pair cable.
Also, use the shielded wire as short as possible.
- * 2 Ground the shield through the cable clamp or terminal block.
Depending on noise conditions, however, it is recommended to ground the shield on the external device side.

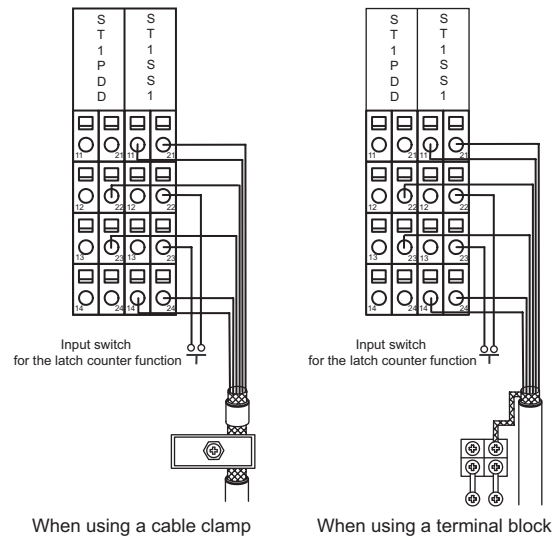

Figure 4.6 When using a cable clamp or a terminal block

4.4.3 Cable connected between the ST1SS1 and absolute encoder

Connect the ST1SS1 to the absolute encoder with a shielded twisted pair cable whose cross section is 0.2mm² or more (AWG24 or thicker).

However, always confirm the specifications of the absolute encoder.

(1) Relation between the baud rate and the maximum cable length (reference values)

Table 4.4 Relation between the baud rate and the maximum cable length

Baud rate	125kHz	250kHz	500kHz	1MHz	2MHz
Max. cable length	320m	160m	60m	20m	8m

The maximum cable lengths shown in the above table have been ensured for the absolute encoder, CEV-58-M SSI (manufactured by TR ELECTRONIC GmbH). The shown values are not guaranteed because they may change depending on the connected absolute encoder. Treat them as reference values.

☒ POINT

If the maximum cable length is exceeded, one of the following will occur.

- (1) The encoder value is fixed to an erroneous value, and no error is detected.*1
- (2) The encoder value fluctuates erratically, and an error is detected.
- (3) The encoder value cannot be read, and an error is detected.

*1: Using the parity check or CRC check will raise the error detection rate.

CHAPTER5 GX Configurator-ST

This chapter explains the functions of GX Configurator-ST used with the ST1SS1. For details of GX Configurator-ST, refer to the following.

 GX Configurator-ST Operating Manual

5.1 GX Configurator-ST Functions

Table 5.1 lists the GX Configurator-ST functions used with the ST1SS1.

Table 5.1 List of GX Configurator-ST Functions Used with ST1SS1

Item	Description	Reference section
Parameter Setting	(1) The following parameter items can be set in GX Configurator-ST. <ul style="list-style-type: none"> • SSI baud rate setting • SSI direction reversal setting • SSI code setting • SSI code length setting • SSI parity setting • SSI trailing bits setting • SSI monoflop time setting • Latch mode setting • Coincidence detection flag setting • Coincidence detection value setting (2) Specify the area (RAM or ROM) where parameter settings will be registered. (3) Using GX Configurator-ST, parameters can be set even while online module change is performed.	Section 5.3
Input/output monitor	(1) The I/O data of the ST1SS1 can be monitored.	Section 5.4
Forced output test	(1) Test can be conducted with the values set in the Bw bit output area of the ST1SS1.	Section 5.5
Online module change	(1) A module can be replaced without the system being stopped.	CHAPTER 7

5.2 Creating a Project

(1) Creating a project

A new project can be created by reading the real MELSEC-ST system from the communication port and by creating it offline if there is no MELSEC-ST system. For more details about creating a project, refer to the following.

 GX Configurator-ST Operating Manual

(2) Selecting a head module

To create a project offline, "CC-Link (ST1H-BT)" must be selected in the next screen, and then click the button.

(3) Display/setting screen

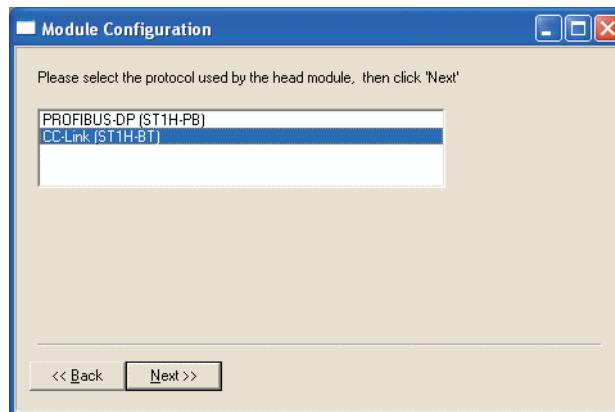

Figure 5.1 Selecting a head module

5.3 Parameter Setting

This section explains how to set the parameters.
 If the parameters are set with GX Configurator-ST, the programs used to set the parameters are not required anymore.
 If these parameters should be used every time when the MELSEC-ST system starts up, these must be written to the ROM.
 (Writing the parameters to the RAM is used only for temporary testing.)

(1) Mode changing

The mode need not be changed.
 Parameter setting is available in both edit and diagnosis modes.

(2) Displaying "Parameter Setting" screen

- (a) Select ST1SS1 on the "Module Configuration" or "System Monitor" screen.
- (b) Click [Edit] → [Parameter Setting].

(3) Display/Setting Screen

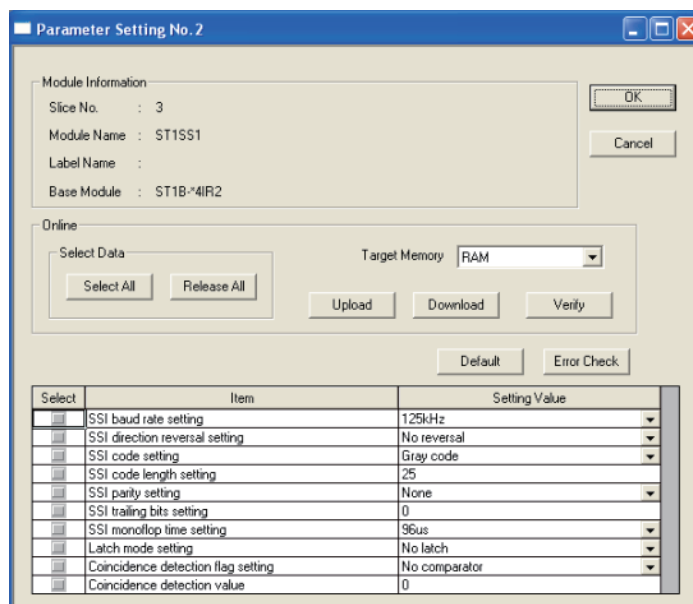

Figure 5.2 Parameter Setting screen

(4) Display/setting details

- (a) SSI baud rate setting
Set an SSI baud rate.
Select an option from 125kHz, 250kHz, 500kHz, 1MHz and 2MHz.
- (b) SSI direction reversal setting
Set whether to reverse the rotation direction or not.
No reversal : Rotation is not reversed.
Reversal : Rotation can be reversed.
- (c) SSI code setting
Set the SSI code. (Gray code or Binary code)
- (d) SSI code length setting
Set the SSI code length.
The setting range is 2 to 31 bits.
- (e) SSI parity setting
Set the SSI parity.
None : No parity check
Even : Even parity check
Odd : Odd parity check
- (f) SSI trailing bits setting
Set the number of SSI trailing bits.
The setting range is from 0 to 15 bits.
- (g) SSI monoflop time setting
Set the SSI monoflop time.
Select an option from 48 μ s, 64 μ s, 80 μ s, and 96 μ s.
- (h) Latch mode setting
Specify the latch mode setting. (No latch, Rising edge, Falling edge or Rising + falling edge)
- (i) Coincidence detection flag setting
Set the condition for the coincidence detection.
No comparator : No coincidence detection
Upward : Detect at the set value or higher
Downward : Detect at the set value or lower
Upward + Downward: Detect at the set value or higher + or lower
- (j) Coincidence detection value
Set a value for coincidence detection.
The setting range is from 0 to 2147483647 bits.

(5) Parameter writing

- 1) In "Input/Output Monitor" of GX Configurator-ST, check that Bw.n+1 Convert setting request is OFF (0). (☞ Section 5.4 Input/Output Monitor)
- 2) Select parameter items to be written to the ST1SS1 by checking the corresponding "Select" check boxes.
- 3) Set values in the "Setting Value" fields.
- 4) Select the target memory (RAM or ROM) from the pull-down menu of "Target Memory".
- 5) Click the button.

☒ POINT

Before writing parameters, make sure that Bw.n+1 Convert setting request is OFF (0).

If it is ON (1), parameters cannot be written.

5.4 Input/Output Monitor

This section explains how to monitor the I/O data of the ST1SS1.

(1) Mode changing

Click [Mode] → [Diagnosis].

(2) "Input/Output Monitor" screen display

1) Select ST1SS1 on the "System Monitor" screen.

2) Click the button.

Monitoring starts as soon as the "Input/Output Monitor" screen is displayed.

(3) Display/setting screen

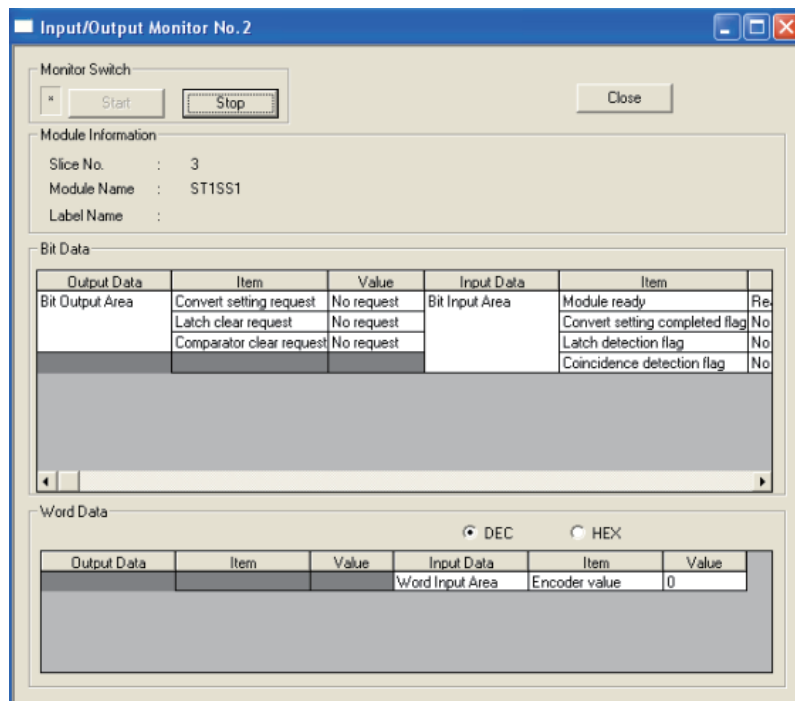

Figure 5.3 Input/Output Monitor screen

(4) Display/setting details

(a) Bit Data

Table 5.2 Bit Data list

Input/Output Data	Item	Description
Bit Output Area	Convert setting request	The status of <input type="checkbox"/> Bw.n+1 Convert setting request is displayed.
	Latch clear request	The status of <input type="checkbox"/> Bw.n+2 Latch detection clear request is displayed.
	Comparator clear request	The status of <input type="checkbox"/> Bw.n+3 Comparator clear request is displayed.
Bit Input Area	Module ready	The status of <input type="checkbox"/> Br.n Module READY is displayed.
	Convert setting completed flag	The status of <input type="checkbox"/> Br.n+1 Convert setting completed flag is displayed.
	Latch detection flag	The status of <input type="checkbox"/> Br.n+2 Latch detection flag is displayed.
	Coincidence detection flag	The status of <input type="checkbox"/> Br.n+3 Coincidence detection flag is displayed.

(b) Word Data

The display format (decimal/hexadecimal) can be changed.

Table 5.3 Word Data list

Input/Output Data	Item	Description
Word Input Area	Encoder value	<input type="checkbox"/> Wr.n Encoder value (Low) and <input type="checkbox"/> Wr.n+1 Encoder value (High) are displayed.

5.5 Forced Output Test

This section explains how to perform a forced output test. Conduct the test after setting values to the bit output area of the ST1SS1.

(1) Mode changing

Click [Mode] → [Diagnosis].

(2) "Forced Output Test" screen display

1) Select ST1SS1 on the "System Monitor" screen.

2) Click the Forced Output Test Test button.

(3) Display/setting screen

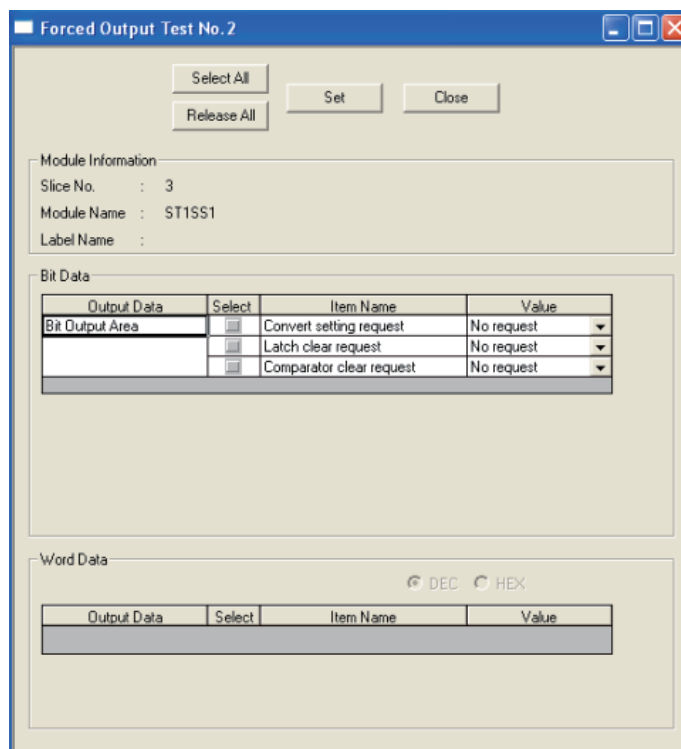

Figure 5.4 Forced Output Test screen

(4) Display/setting details

(a) Bit Data

Table 5.4 Bit Data list

Output Data	Item	Description
Bit Output Area	Convert setting request	The setting of Bw.n+1 Convert setting request can be changed.
	Latch clear request	The setting of Bw.n+2 Latch detection clear request can be changed.
	Comparator clear request	The setting of Bw.n+3 Comparator clear request can be changed.

(b) Word Data

Unavailable for the ST1SS1.

(5) Test operation

- 1) Select a test item by checking the corresponding "Select" check box.
- 2) Set a value in the "Value" field.
- 3) Click the button.*¹

Clicking the button executes the test.

* 1 When the module is not in the forced output test mode, a dialog appears asking whether to switch to the forced output test mode. Click the button to switch to the forced output test mode. When the forced output test mode is activated, the RUN LED of the head module start flashing.

☒ POINT

When the forced output test mode has been cancelled, make sure that the RUN LED of the head module is on.

CHAPTER6 PROGRAMMING

This chapter describes example programs available when the QJ61BT11N is used as a master station.

Remark

For details of the QJ61BT11N, refer to the following manual.

 CC-Link System Master/Local module User's Manual

6.1 Programming Procedure

According to the following procedure, create a program for executing the counting of the ST1SS1.

When applying any of the program examples introduced in this chapter to the actual system, verify the applicability and confirm that no problems will occur in the system control.

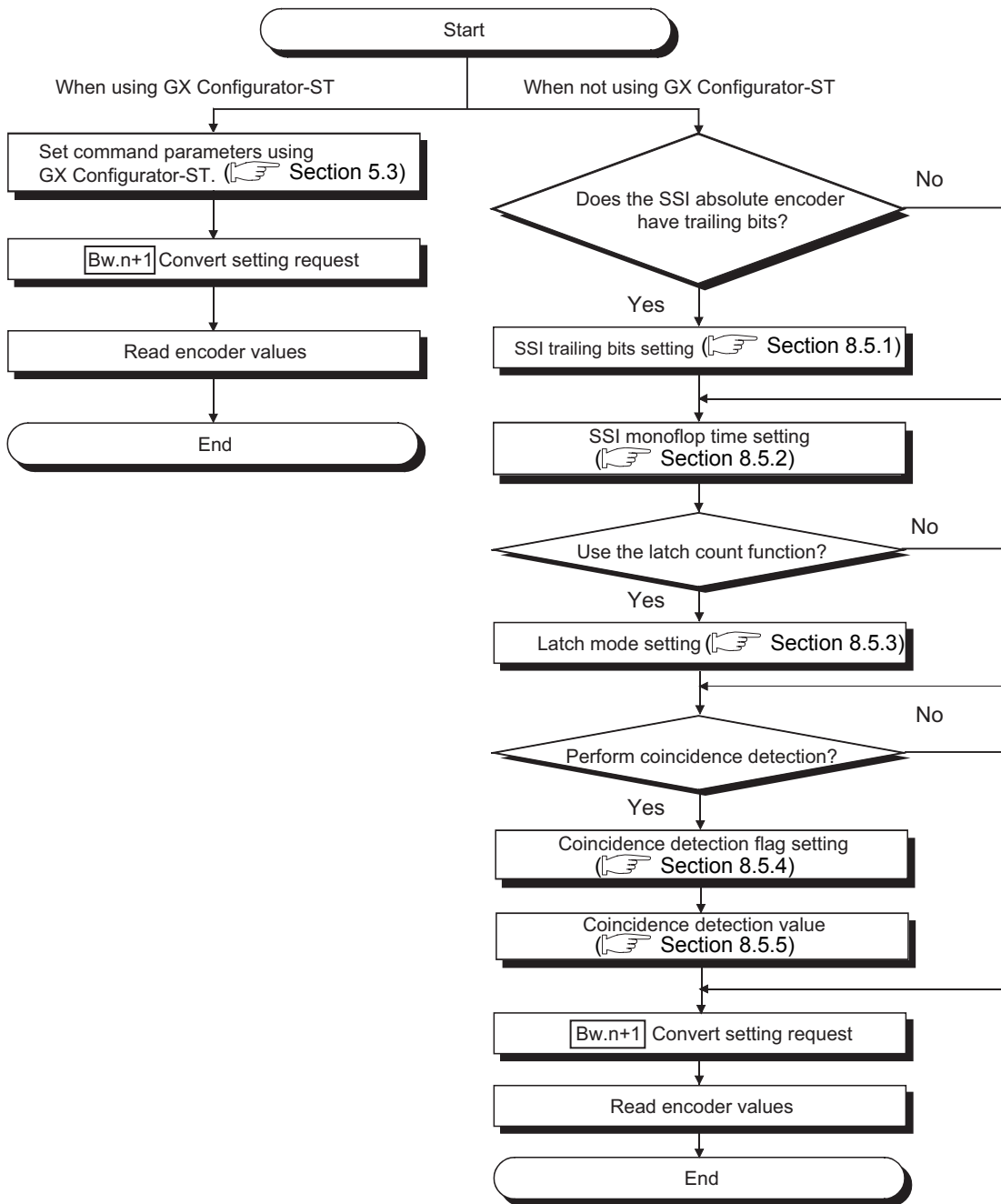



Figure 6.1 Programming procedure

POINT

- (1) With one dedicated instruction (RDMSG), up to eight commands can be simultaneously executed.
However, the following commands cannot be executed with any other command at the same time.
Initial data batch write request (command No.: 8106H)
Initial data individual write request (command No.: 8107H/0107H)
If executed simultaneously, an error will occur.
- (2) The sizes of **[Cw]** Command execution area and **[Cr]** Command result area vary depending on the command.
- (3) In the following cases, commands cannot be executed. Therefore, execute the command after following cases finished.
 - The head module is executing the self-diagnostic function.
 - A slice module is being replaced online.
 - Another command is in execution. (The dedicated instruction (RDMSG) is not completed.)
- (4) For online module change, advance preparation may be required depending on the operating conditions. For details, refer to the following.
 Section 7.2 Preparations for Online Module Change

6.2 System Configuration Example

The following system example is used for the programs described in this chapter.

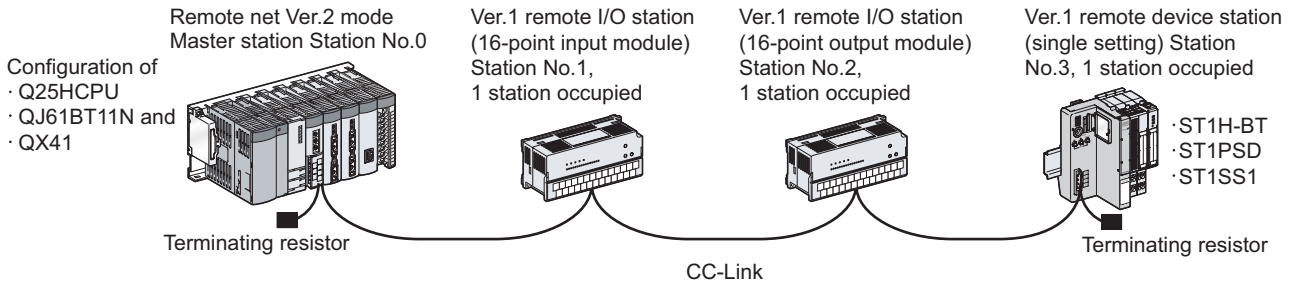

Figure 6.2 System configuration example

(1) System configuration of master station

Table 6.1 System configuration of master station

Module	Input signal	Output signal
Q25HCPU	-	-
QJ61BT11N	X00 to X1F	Y00 to 1F
QX41	X20 to X3F	-

(2) MELSEC-ST system configuration

Table 6.2 I/O points sheet

Slice position No.	Start slice No. (No. of occupied slices)	Module name	Br.n	Bw.n	Wr.n	Ww.n	5V DC internal current consumption (Total)	24V DC current (Total)	Slot width (Total)
0	0(2)	ST1H-BT	0	0	0	0	0.410A(0.410A)	0A(0A)	-
1	2(1)	ST1PSD	0	0	0	0	-	-	25.2mm (25.2mm)
2	3(2)	ST1SS1	4	4	2	0	0.080A (0.490A)	*1	12.6mm (37.8mm)
Total			4	4	2	0	-	-	37.8mm (850mm or more)
			(252 bits or less)*2	(252 bits or less)*2	(52 words or less)	(52 words or less)			

* 1 The 24V DC current varies depending on the external device connected to each slice module. Check the current consumption of external devices connected to slice modules, and calculate the total value. (MELSEC-ST System User's Manual)

* 2 The number of available points reduces by two points for each additional power distribution module.

6.3 Settings and Communication Data

After determining the system configuration, set parameters of the programmable controller CPU of the master station.

(1) Setting PLC parameters (I/O assignment)

Connect GX Developer to the programmable controller CPU of the master station, and set PLC parameters as shown below.

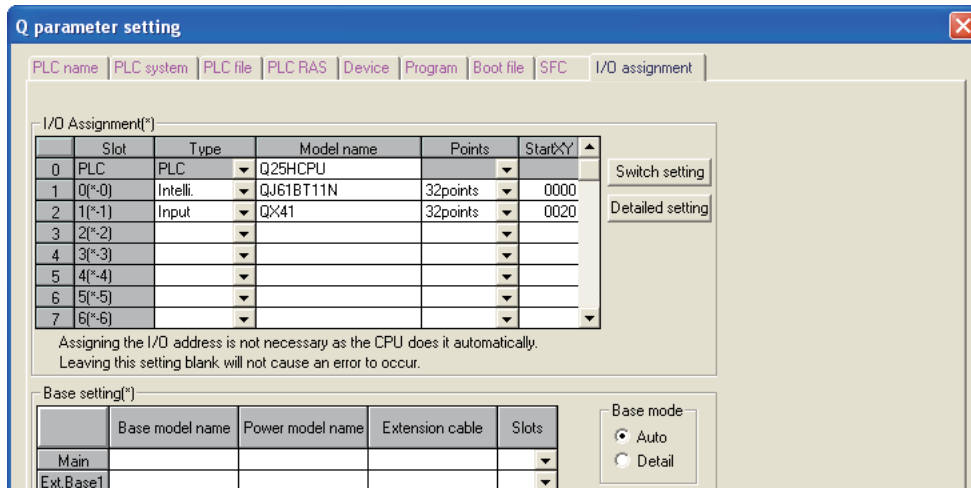

Figure 6.3 I/O assignment

(2) Network parameters

Connect GX Developer to the programmable controller CPU of the master station, and set network parameters as shown below.

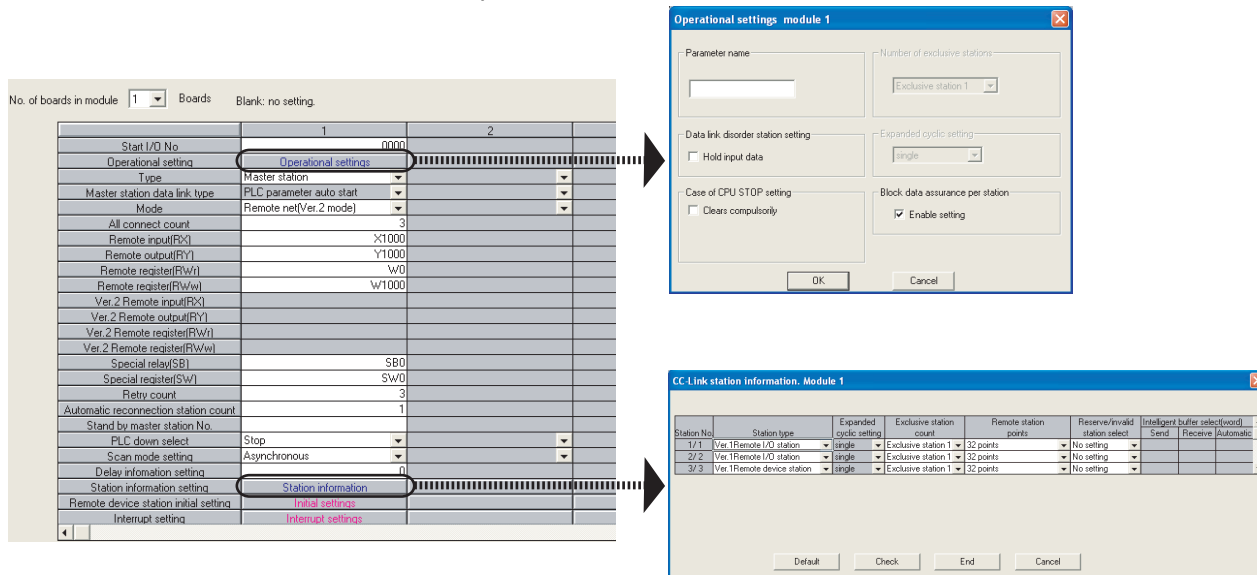

Figure 6.4 Setting network parameters

(3) I/O data assignment

The following are I/O data assignment results for the system configuration example in this chapter.

The I/O points sheet is useful for I/O data assignment.

For details of the I/O data assignment sheet, refer to the following.

☞ MELSEC-ST CC-Link Head Module User's Manual, "Appendix 3.2 Input data assignment sheet, Appendix 3.3 Output data assignment sheet"

(a) "Br" Bit input area (Remote input (RX))

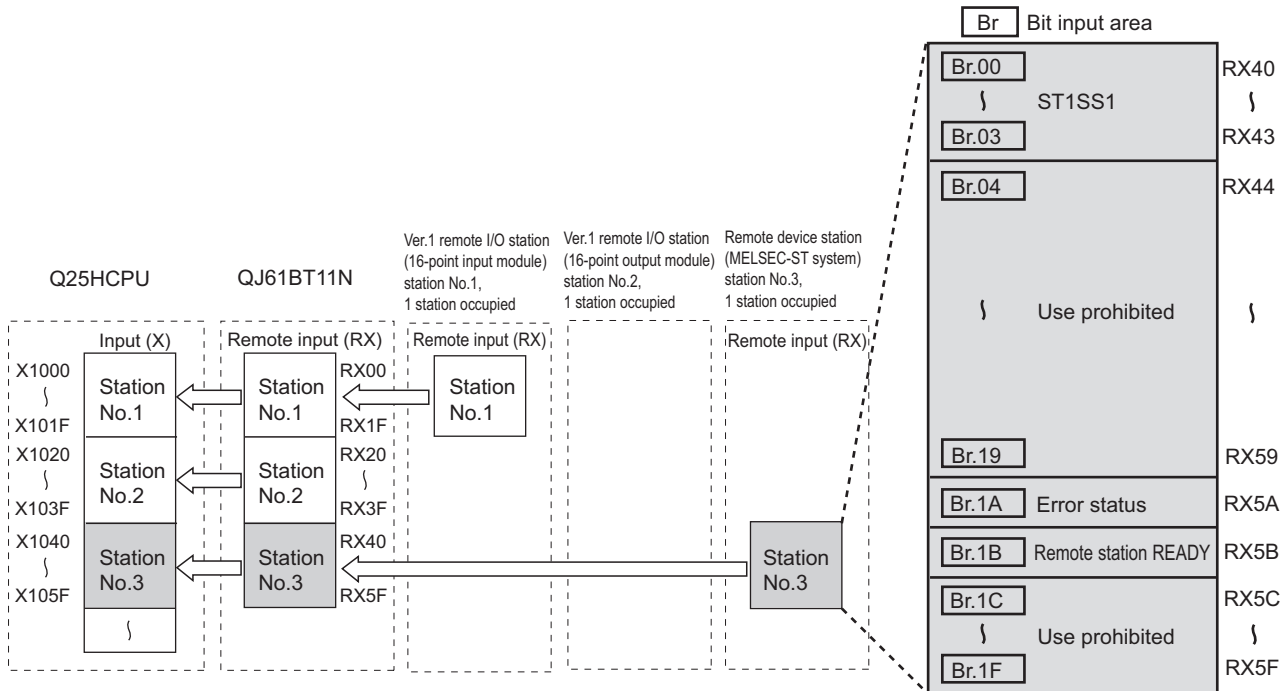

Figure 6.5 "Br" Bit input area (remote input (RX))

Table 6.3 "Br" Bit input area assignment sheet

Master station		Remote device station (MELSEC-ST system)			
Device	Remote input (RX)	Slice position No.	Module name	Br.n	Data name
X1040	RX40	2	ST1SS1	Br.00	Module READY
X1041	RX41			Br.01	Convert setting completed flag
X1042	RX42			Br.02	Latch detection flag
X1043	RX43			Br.03	Coincidence detection flag
X1044	RX44			-	-
to		to			
X1059	RX59	-	-	Br.19	Use prohibited
X105A	RX5A	-	-	Br.1A	Error status *1
X105B	RX5B	-	-	Br.1B	Remote station READY *1
X105C	RX5C	-	-	Br.1C	Use prohibited
to		to			
X105F	RX5F	-	-	Br.1F	Use prohibited

* 1 Error status (RXnA) and Remote station READY (RXnB) are remote input areas of the head module. For details of remote input, refer to the following.

☞ MELSEC-ST CC-Link Head Module User's Manual, "3.4 Remote I/O, Remote Registers"

(b) "Bw" Bit output area (Remote output (RY))

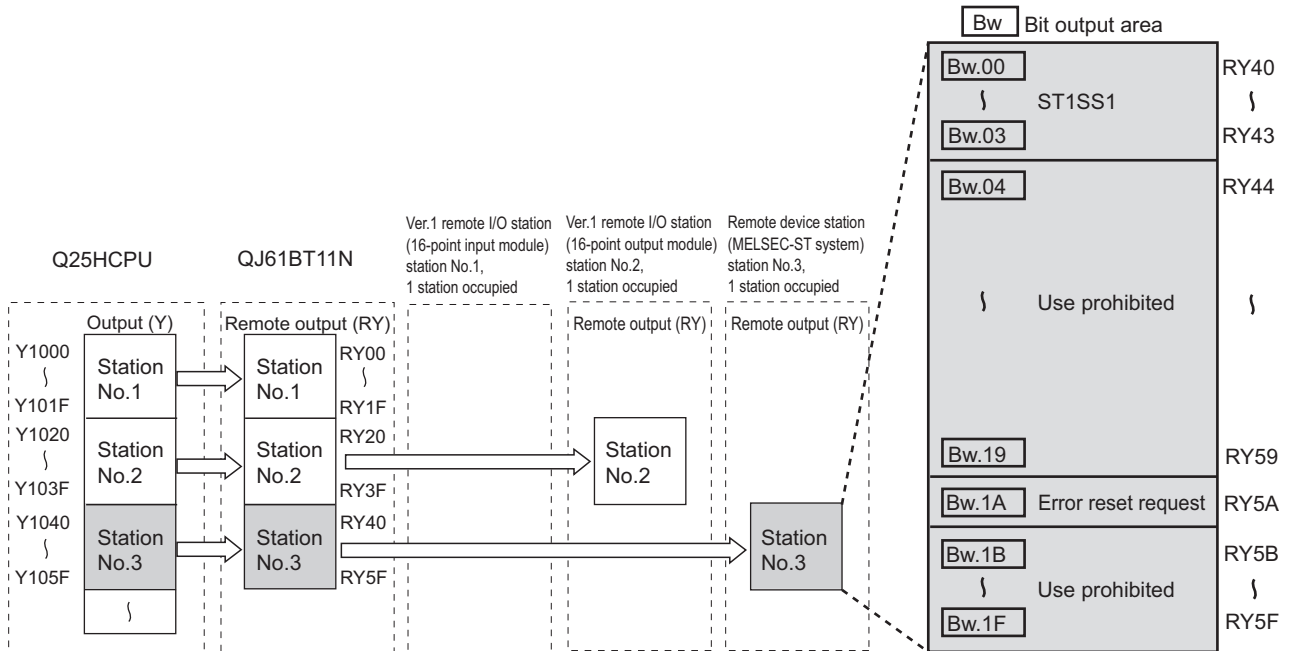

Figure 6.6 "Bw" Bit output area (Remote output (RY))

Table 6.4 "Bw" Bit output area assignment sheet

Master station		Remote device station (MELSEC-ST system)			
Device	Remote output (RY)	Slice position No.	Module name	Bw.n	Data name
Y1040	RY40	2	ST1SS1	Bw.00	Use prohibited
Y1041	RY41			Bw.01	Convert setting request
Y1042	RY42			Bw.02	Latch detection clear request
Y1043	RY43			Bw.03	Comparator clear request
Y1044	RY44	-	-	Bw.04	Use prohibited
to		to			
Y1059	RY59	-	-	Bw.19	Use prohibited
Y105A	RY5A	-	-	Bw.1A	Error reset request ^{*1}
Y105B	RY5B	-	-	Bw.1B	Use prohibited
to		to			
Y105F	RY5F	-	-	Bw.1F	Use prohibited

* 1 Error reset request (RYnA) is a remote output area of the head module. For details of Error reset request (RYnA), refer to the following.

👉 MELSEC-ST CC-Link Head Module User's Manual, "3.4 Remote I/O, Remote Registers"

(c) "Wr" Word input area (remote input (RWr))

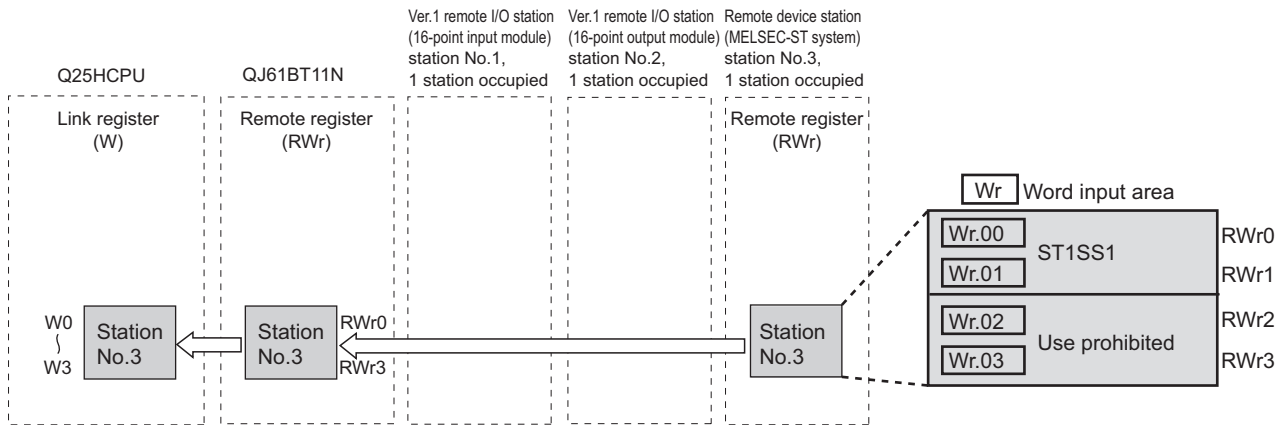

Figure 6.7 "Wr" Word input area (remote input (RWr))

Table 6.5 "Wr" Word input area assignment sheet

Master station		Remote device station (MELSEC-ST system)			
Device	Remote register (RWr)	Slice position No.	Module name	Wr.n	Data name
W0	RWr0	2	ST1SS1	Wr.00	Encoder value (Low)
W1	RWr1			Wr.01	Encoder value (High)
W2	RWr2	-	-	Wr.02	Use prohibited
W3	RWr3			Wr.03	Use prohibited

6.4 Program Examples

A program example is shown below.

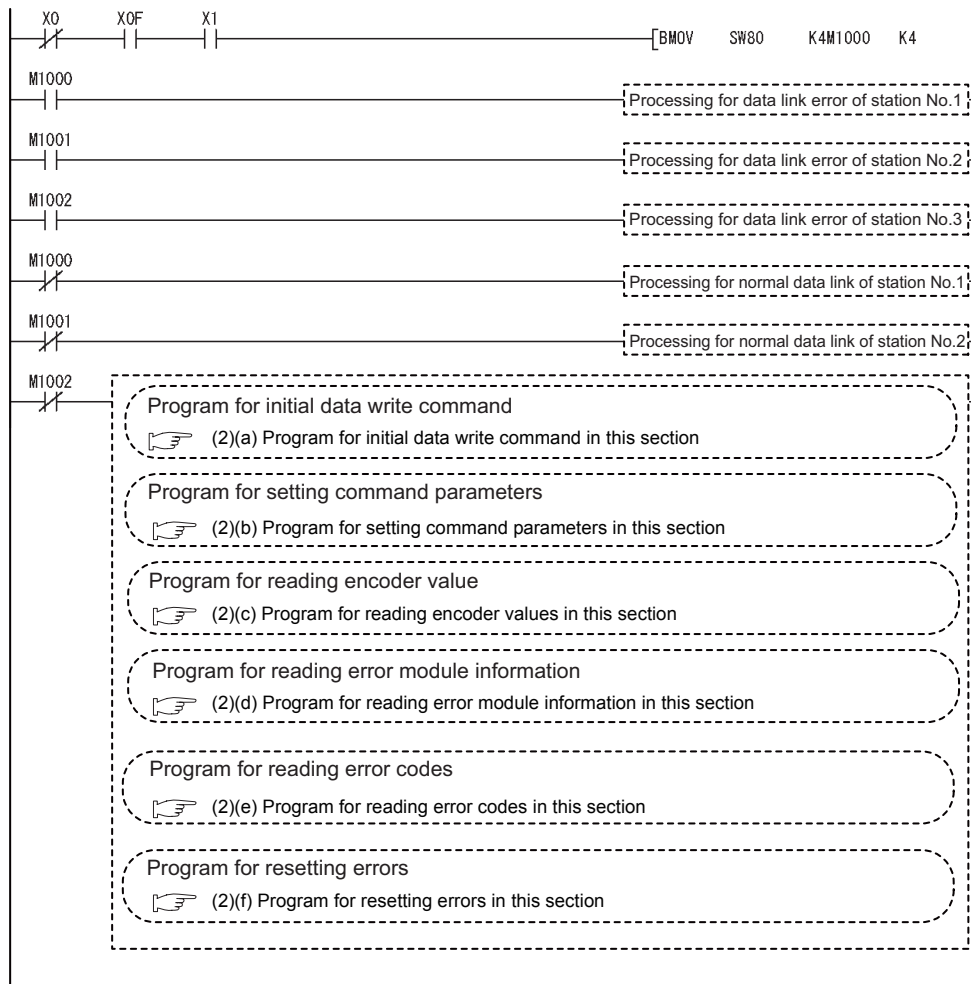



Figure 6.8 Program example

(1) Device assignments in program examples

The devices used common to the program examples (2) in this section and later are shown below.

For devices used for each program example, refer to the following.

 (2) Program examples in this section

(a) Special relay (SM) and special register (SD)

Table 6.6 Special relay (SM) and special register (SD)

Device	Application	Device	Application
SM0	Diagnostic error	SD0	Diagnostic error

(b) Devices used by the QJ61BT11N (master station)

Table 6.7 Devices used by the QJ61BT11N (master station)

Device	Application	Device	Application
X00	Module error		
X01	Own data link status		-
X0F	Module READY		
SB0 to SB1FF	Link special relay (SB) of the QJ61BT11N	SW0 to SW1FF	Link special register (SW) of the QJ61BT11N

(c) Devices used by the user

Table 6.8 Devices for checking Other station data link status

Device	Application	Device	Application
M1000	Other station data link status (station No.1)	M1002	Data link status of the ST1H-BT (station No.3)
M1001	Other station data link status (station No.2)		-

(2) Program examples

(a) Program for initial data write command

Execute Initial data individual write request (command No.: 8107H) with the dedicated instruction (RDMSG) of the master station to set command parameters.

1) Setting details of command parameters

In this program, the following parameters are set.

Table 6.9 Setting details of command parameters

Item		Setting	Reference section
ST1SS1	SSI baud rate setting	125kHz	Section 8.3.2
	SSI direction reversal setting	No reversal	
	SSI code setting	Gray code	
	SSI code length setting	25 bits	
	SSI parity setting	None	

2) Device assignments in the program example

Table 6.10 Device assignments in the program example

Device	Application	Device	Application
M2000	Completion device	D1000 to D1004	Control data
M2001	Completion status indicator device	D1500 to D1506	Send data (execution data of the command)
M3000	Initial data individual write flag	D1700 to D1704	Receive data (result data of the command)

3) Program example

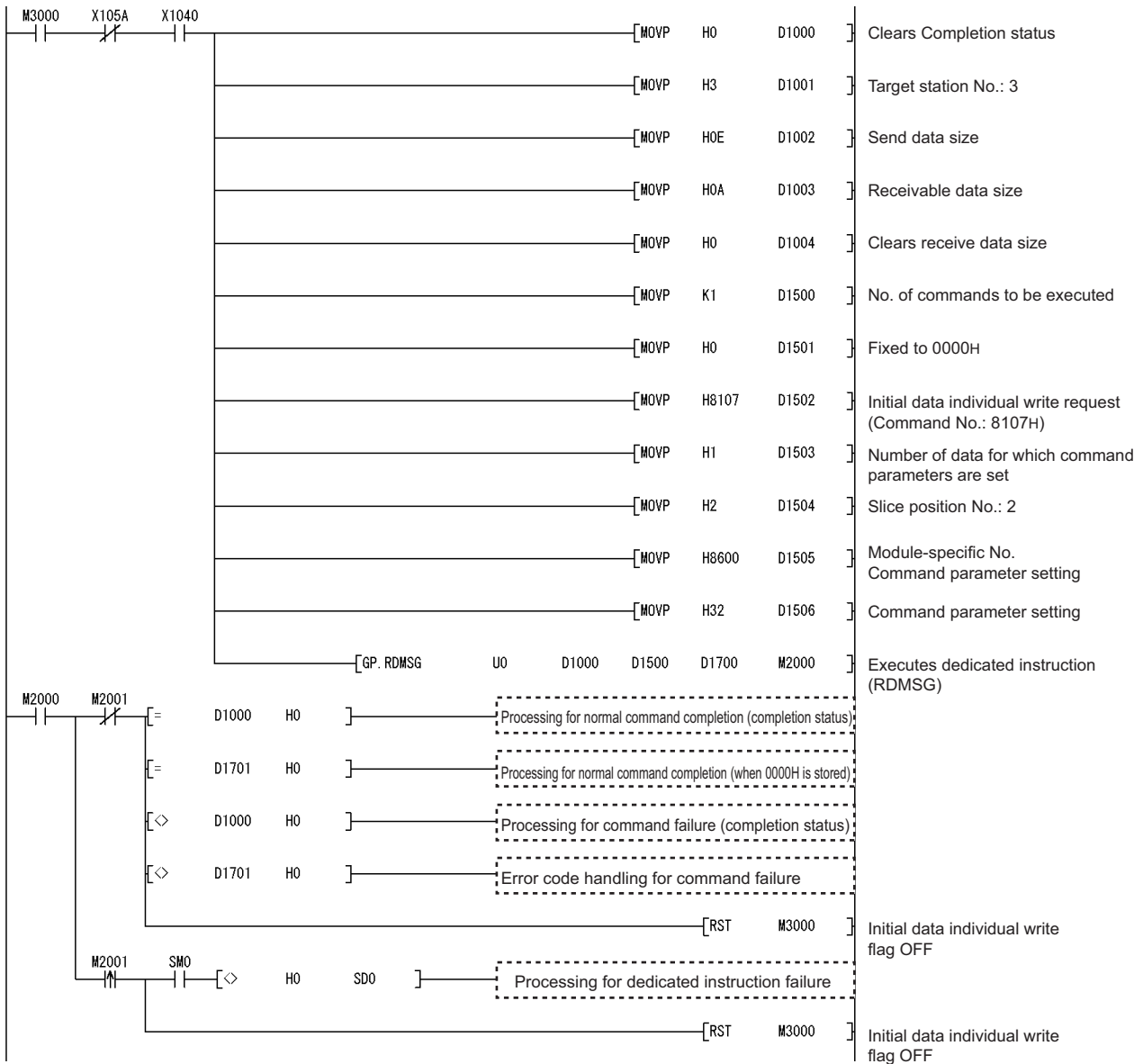

Figure 6.9 Program for initial data write command

(b) Program for setting command parameters

Execute a command of the ST1SS1 with the dedicated instruction (RDMSG) of the master station to set command parameters.

1) Setting details of command parameters

In this program, the following command parameters are set.

Table 6.11 Setting details of command parameters

	Item	Setting	Reference section
ST1SS1	SSI trailing bits setting	8 bits	Section 8.5.1
	SSI monoflop time setting	96 μ s	Section 8.5.2
	Latch mode setting	Rising edge	Section 8.5.3
	Coincidence detection flag setting	Downward	Section 8.5.4
	Coincidence detection value	100000	Section 8.5.5

2) Device assignments in the program example

Table 6.12 Device assignments in the program example

Device	Application	Device	Application
M2010	Completion device (for simultaneous execution of multiple commands)	D1000 to D1004	Control data
M2011	Completion status indicator device (for simultaneous execution of multiple commands)	D1100 to D1104	Send data (for separate execution of each command)
M2020	Completion device (for separate execution of each command)	D1300 to D1304	Receive data (for separate execution of each command)
M2021	Completion status indicator device (for separate execution of each command)	D2000 to D2024	Send data (for simultaneous execution of multiple commands)
M4000	SSI trailing bits setting write flag	D3000 to D3024	Receive data (for simultaneous execution of multiple commands)
M4001	SSI monoflop time setting write flag		
M4002	Latch mode setting write flag		
M4003	Coincidence detection setting write flag		
M4004	Coincidence detection value write flag		
M4005	Command parameter write flag (for simultaneous execution of multiple commands)		

3) Program example (when multiple commands are simultaneously executed)
 The following is a program example for simultaneous execution of multiple commands.

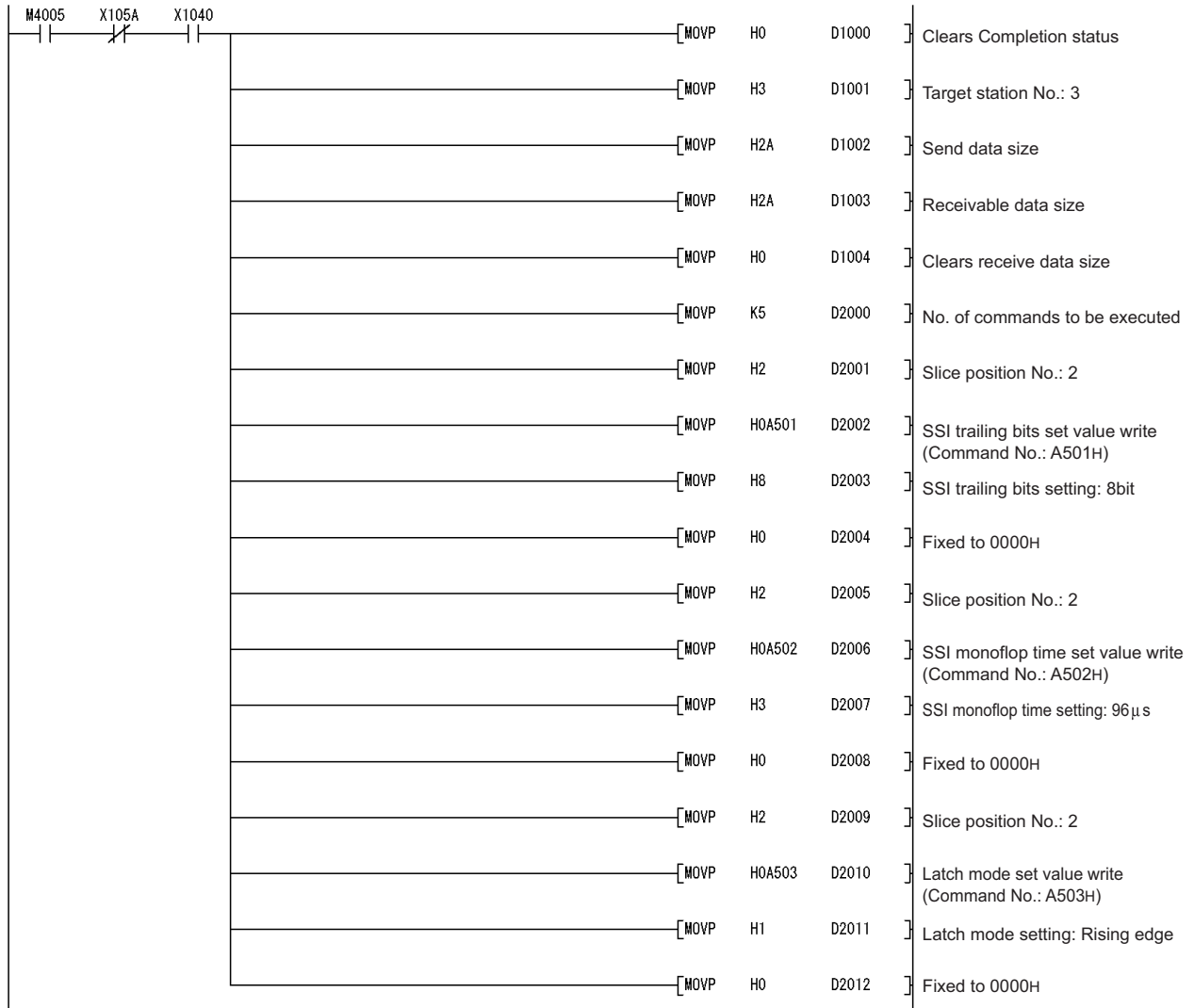

Figure 6.10 Program for setting command parameters (when multiple commands are simultaneously executed)

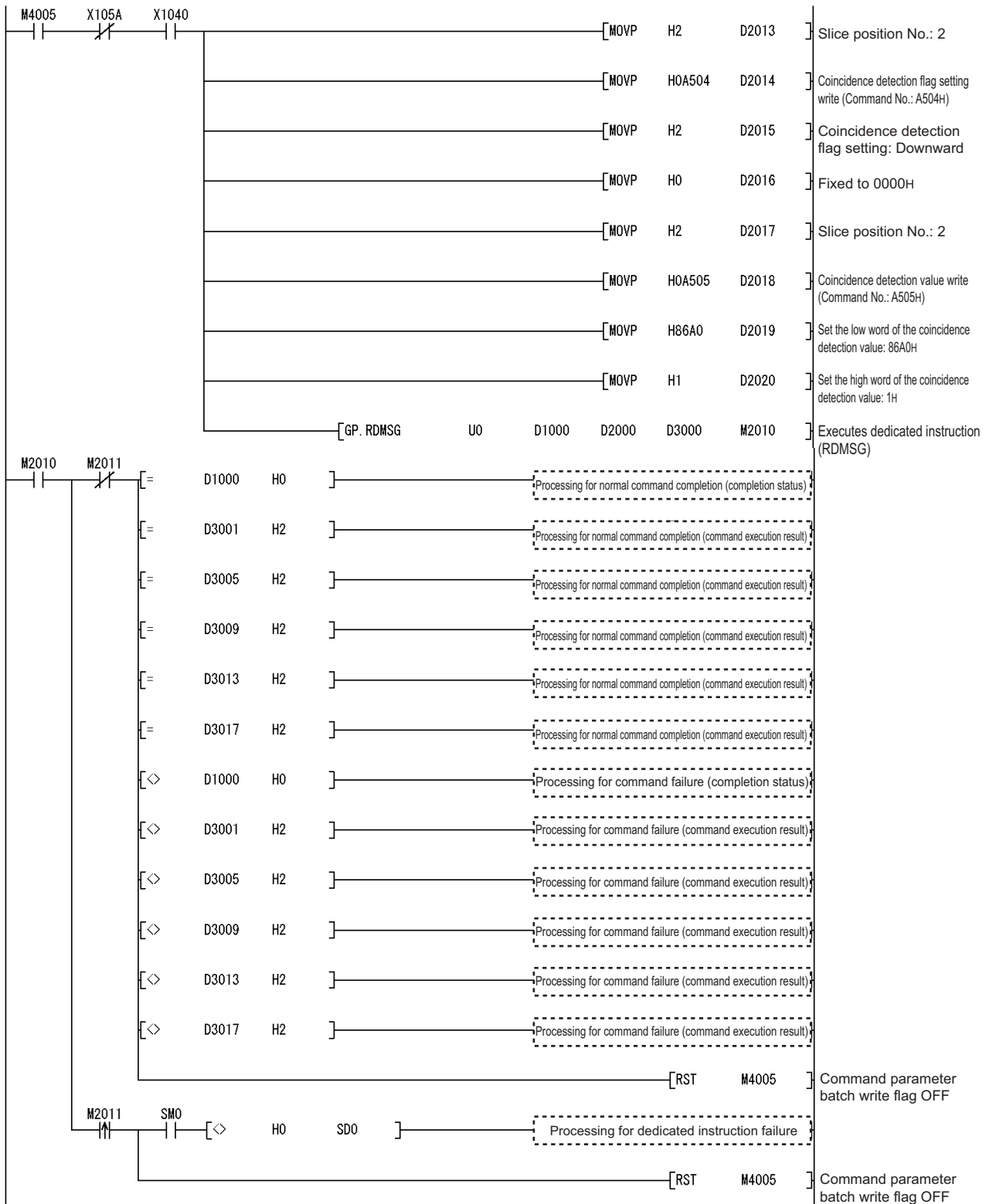

Figure 6.10 Program for setting command parameters (when multiple commands are simultaneously executed) (continued)

4) Program example (when one command is executed at a time)
 The following is a program example for executing a command at a time.

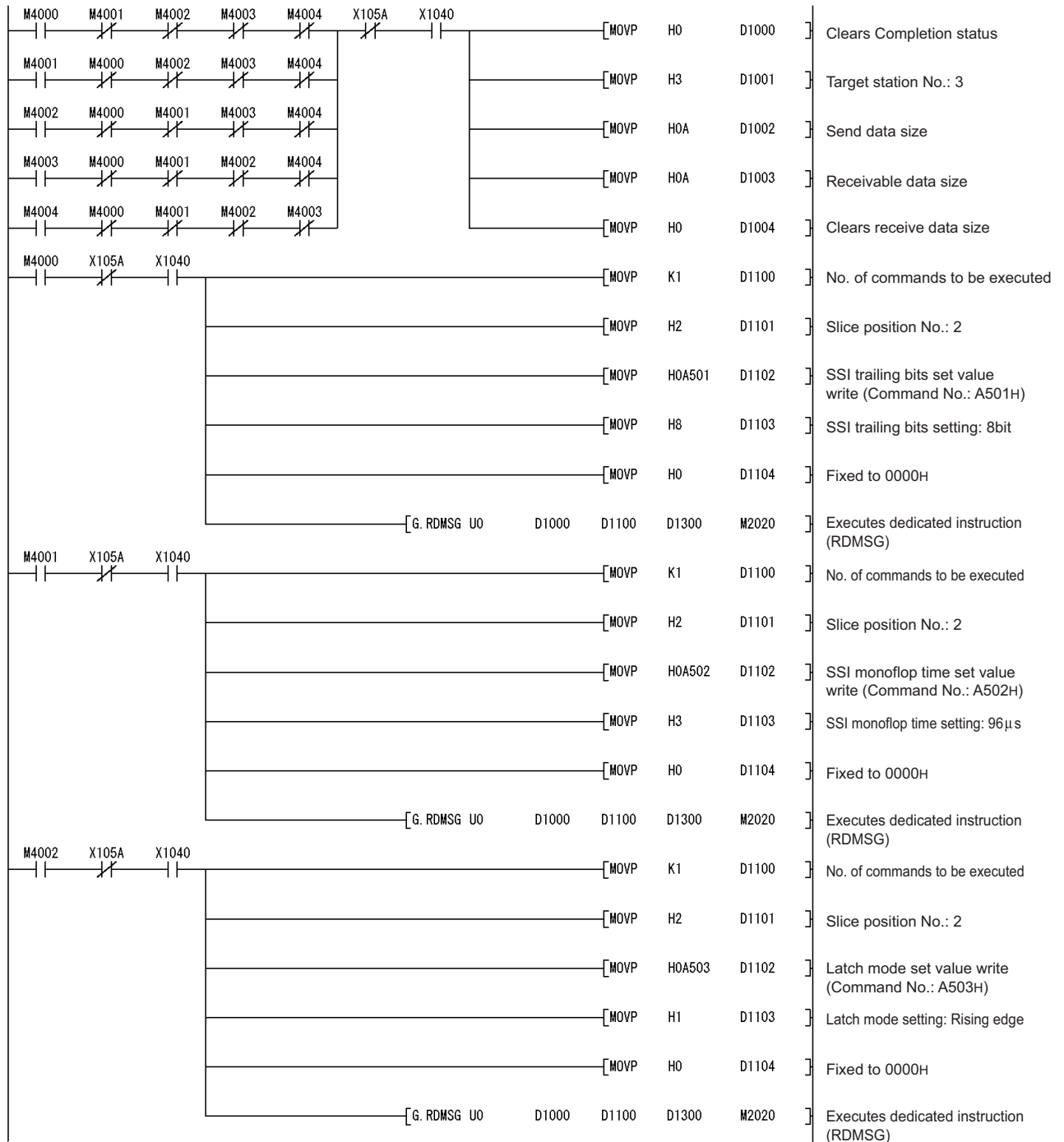

Figure 6.11 Program for setting command parameters (when one command is executed at a time)

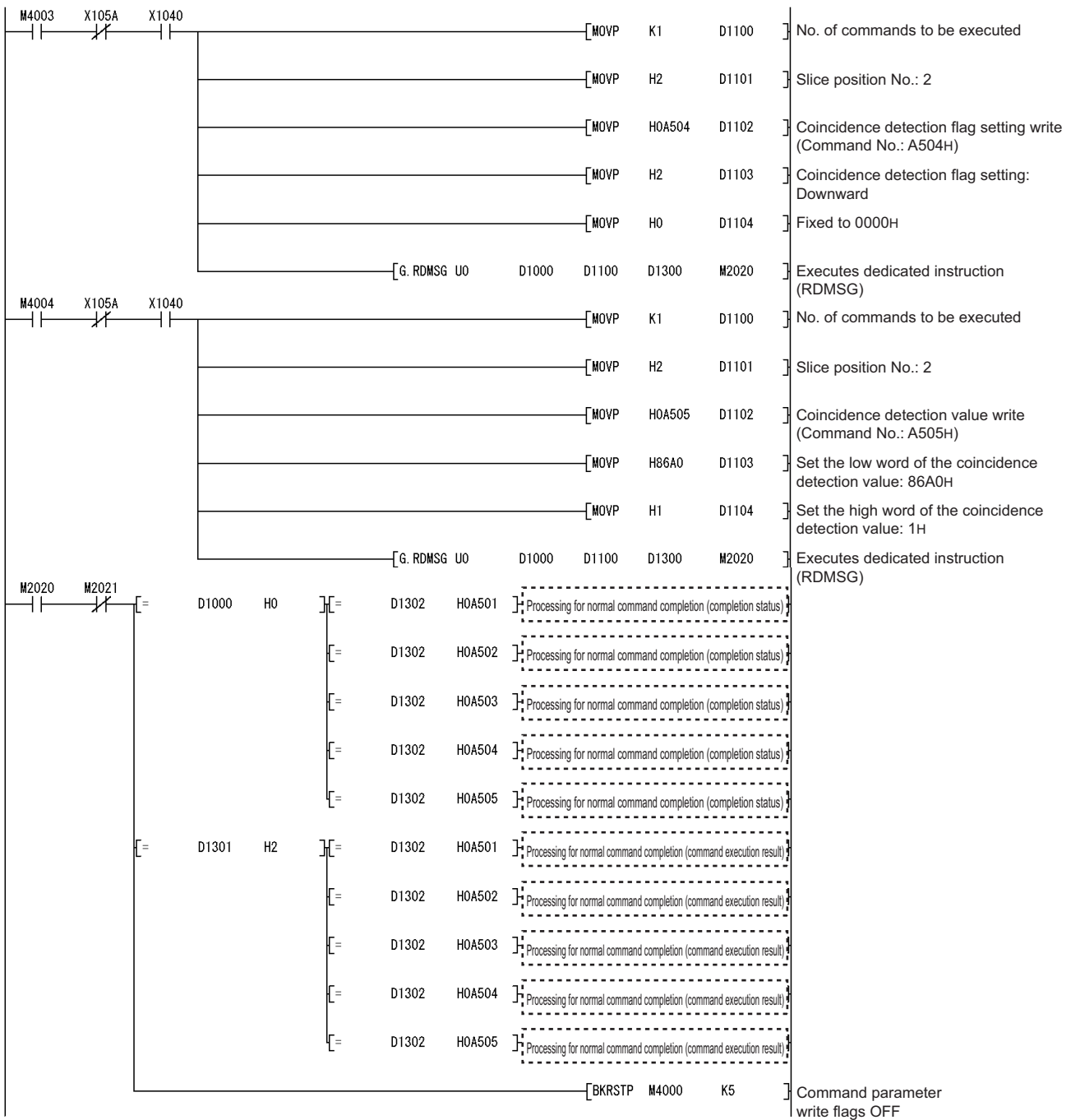

Figure 6.11 Program for setting command parameters (when one command is executed at a time) (continued)

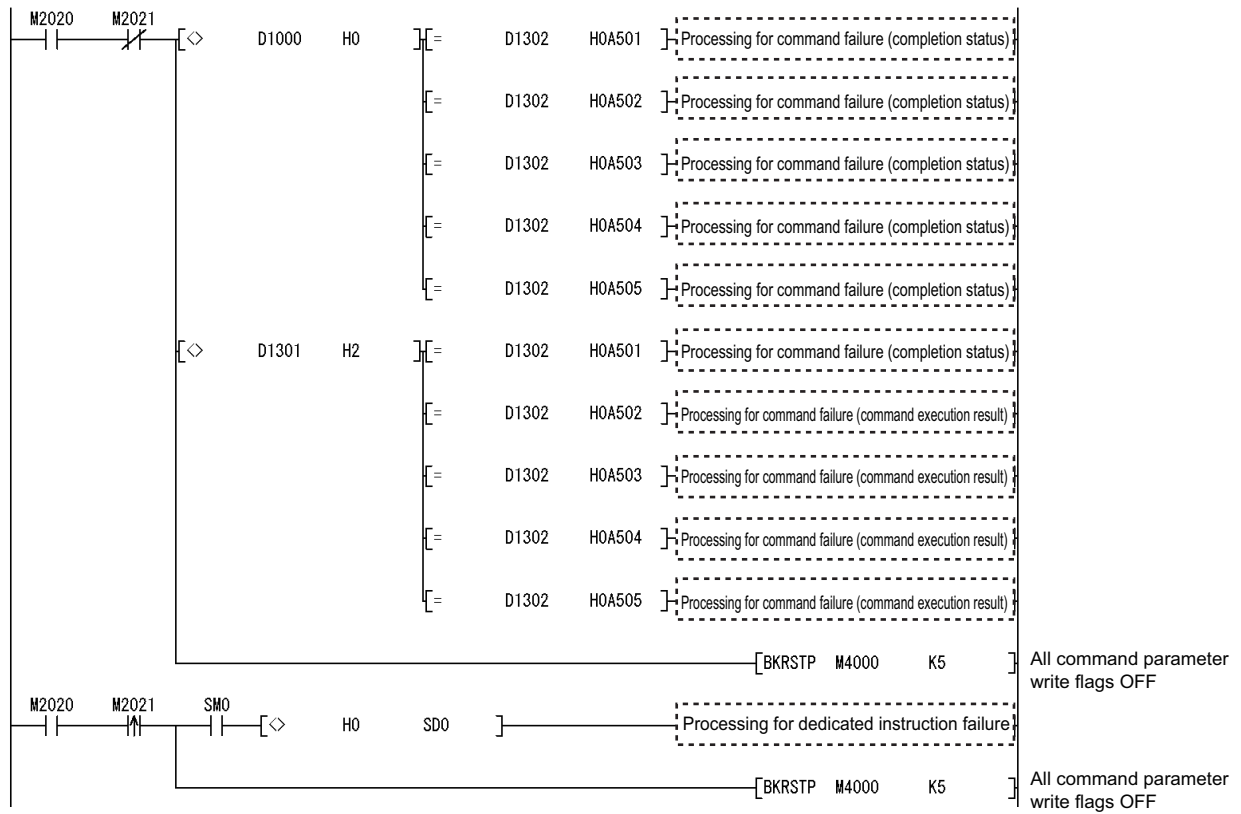

Figure 6.11 Program for setting command parameters (when one command is executed at a time) (continued)

(c) Program for reading encoder values
Encoder values are read out.

1) Device assignment in the program example

Table 6.13 Device assignment in the program example

Device	Application	Device	Application
M4100	Convert setting request flag		

2) Program example

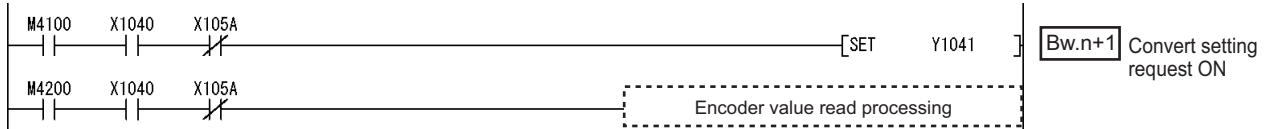



Figure 6.12 Program for reading encoder values

(d) Program for reading error module information

Execute Error module information read request (command No.: 0103H) with the dedicated instruction (RDMSG) of the master station to read the error module information.

Error module information read request is a command of the head module. For details of the command, refer to the following.

 MELSEC-ST CC-Link Head Module User's Manual, "8.2.4 Error module information read request"

1) Device assignments in the program example

Table 6.14 Device assignments in the program example

Device	Application	Device	Application
M2030	Completion device	D1000 to D1004	Control data
M2031	Completion status indicator device	D1100 to D1104	Send data (execution data of the command)
M6000	Error module information storage enabled	D1300 to D1318	Receive data (result data of the command)
-	-	D4000	Error module information read target

2) Program example

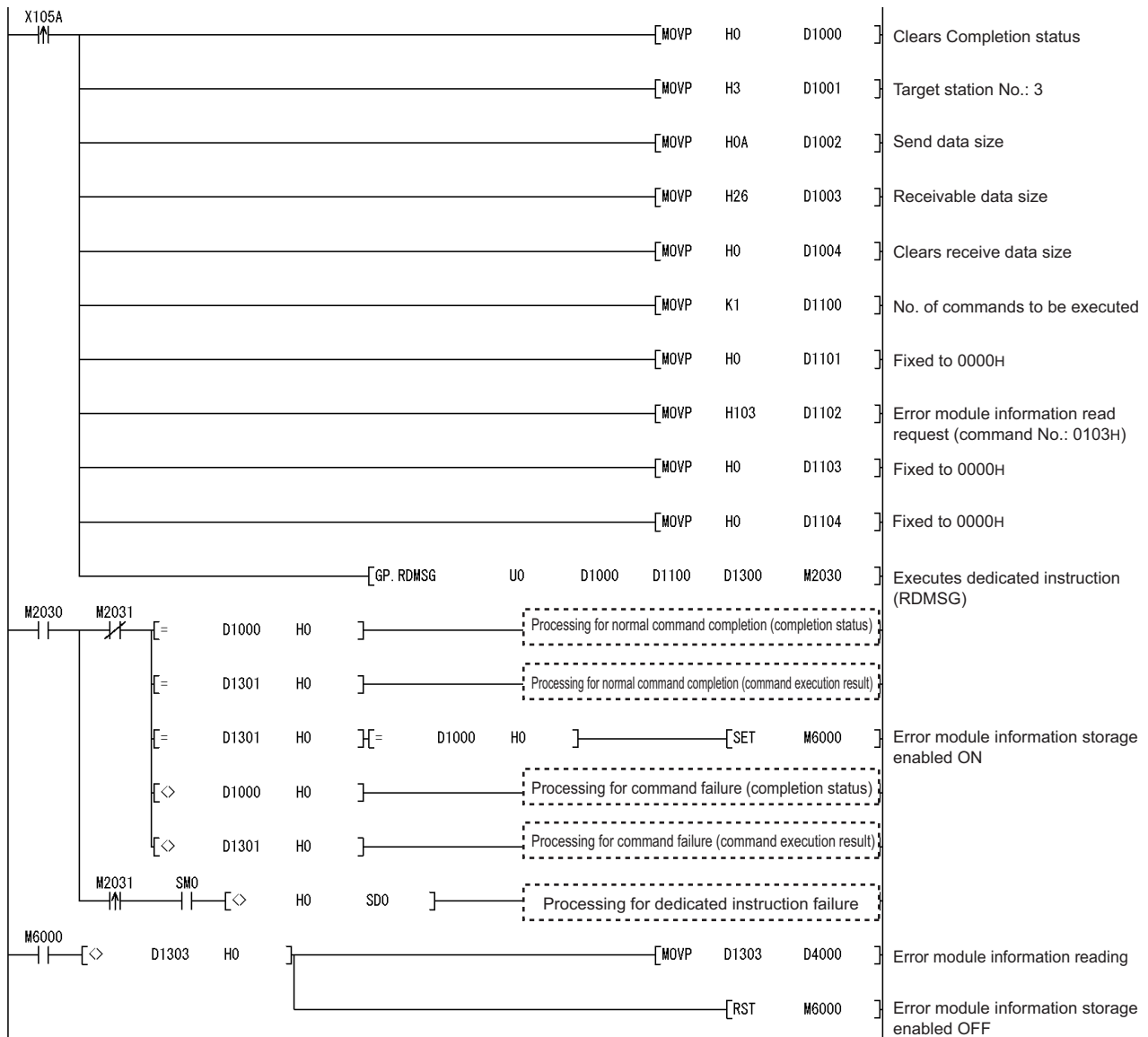



Figure 6.13 Program for reading error module information

(e) Program for reading error codes

Execute Error code read request (command No.: 8101H/0101H) with the dedicated instruction (RDMSG) of the master station to read an error code.

1) Device assignments in the program example

Table 6.15 Device assignments in the program example

Device	Application	Device	Application
M2040	Completion device	D1000 to D1004	Control data
M2041	Completion status indicator device	D1100 to D1104	Send data (execution data of the command)
M5002	Error handling flag	D1300 to D1304	Receive data (result data of the command)
M6001	Error code storage enabled	D4000	Error module information read target  (2)(d) Program for reading error module information in this section
-	-	D4001	Error code read target

2) Program example

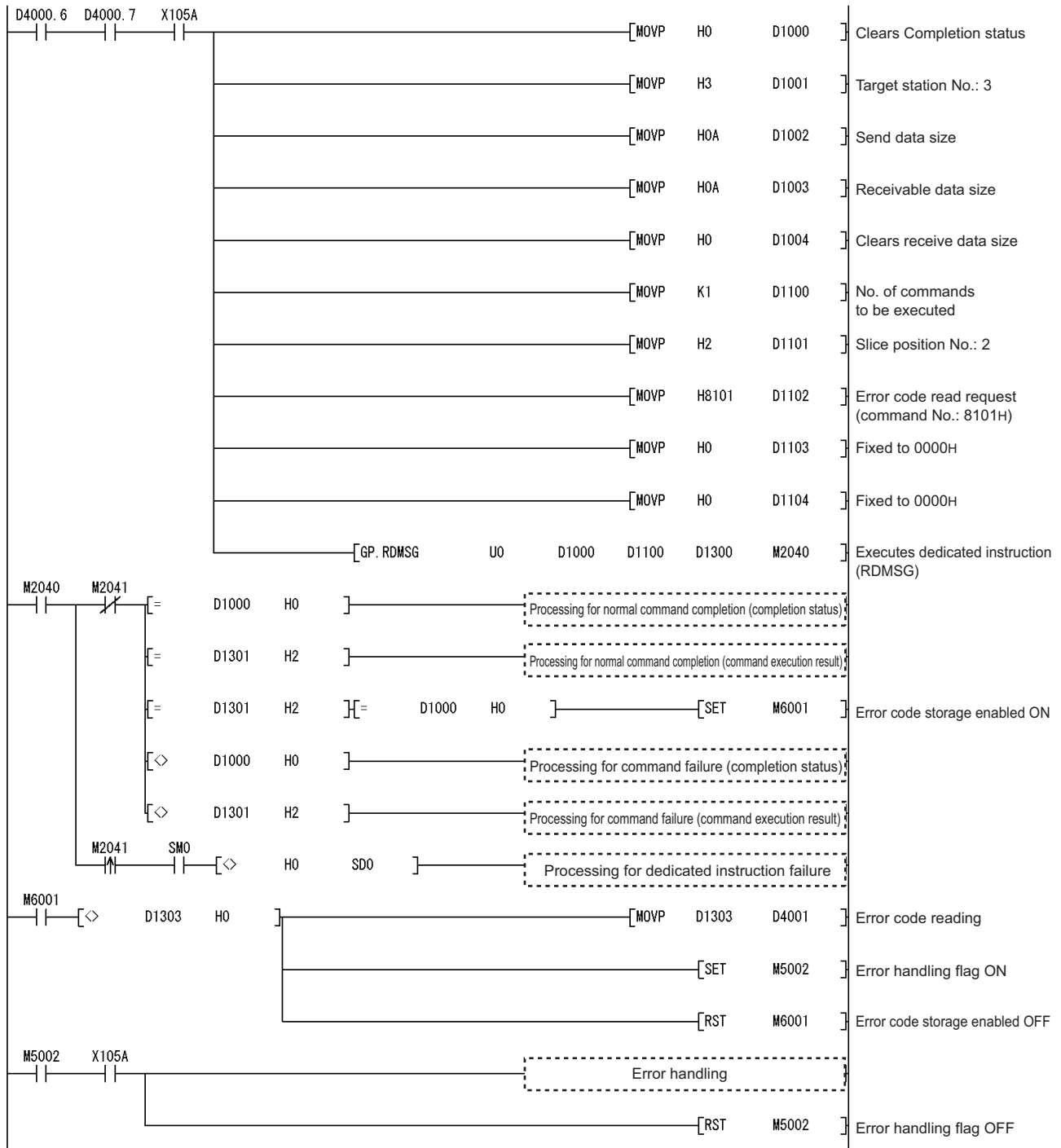

Figure 6.14 Program for reading an error code

(f) Program for resetting errors

Execute Error clear request (command No.: 8104H/0104H) with the dedicated instruction (RDMSG) of the master station to reset errors.

Error clear request is a command of the head module.

For details of the command, refer to the following.

☞ MELSEC-ST CC-Link Head Module User's Manual, "8.2.5 Error clear request"

1) Device assignments in the program example

Table 6.16 Device assignments in the program example

Device	Application	Device	Application
M2050	Completion device	D1000 to D1004	Control data
M2051	Completion status indicator device	D1100 to D1106	Send data (execution data of the command)
M5003	Error reset request flag	D1300 to D1304	Receive data (result data of the command)

2) Program example

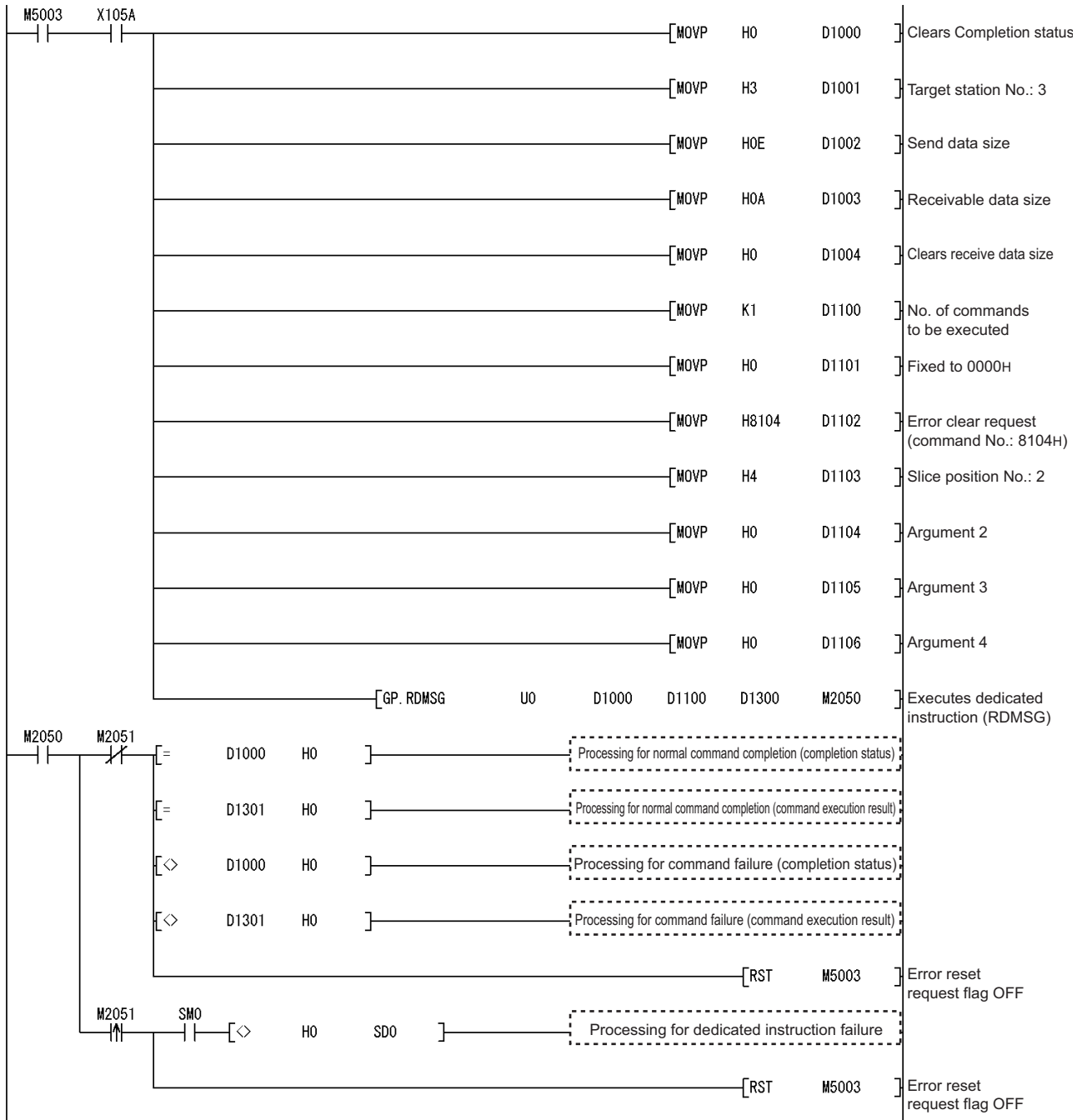

Figure 6.15 Program for resetting errors

CHAPTER7 ONLINE MODULE CHANGE

Before performing online module change, carefully read the following.

☞ MELSEC-ST CC-Link Head Module User's Manual, "4.6 Online Module Change Function"

This chapter describes the specifications of online module change.

- (1) **Perform an online module change by operating the head module buttons or using GX Configurator-ST.**
- (2) **The existing command parameters are automatically loaded into the new module.**

7.1 Precautions for Online Module Change

The following are the precautions for online module change.

(1) System configuration in which online module change is executable

To perform the online module change, the system configuration must be appropriate for execution of the online module change.

For details, refer to the following.

☞ MELSEC-ST System User's Manual, "3.4 Precautions for System Configuration"

Executing the online module change in an inappropriate system configuration may result in malfunction or failure.

In such a system configuration, shut off all phases of the external power supply for the MELSEC-ST system to replace a slice module.

(2) Online module change procedure

Be sure to observe the "online module change procedure" described in the following.

☞ Section 7.4.1 When parameter setting is performed using GX Configurator-ST during online module change

☞ MELSEC-ST CC-Link Head Module User's Manual, "4.6 Online Module Change Function"

Failure to do so can cause a malfunction or failure.

(3) Precautions for external devices during online module change

Before starting an online module change, confirm that the external device connected with the slice module to be removed will not malfunction.

(4) Replaceable slice module

Only the slice modules of the same model name can be replaced online.

Replacing a slice module with a different slice module model and adding a new slice module is not allowed.

(5) Number of replaceable slice modules

Only one slice module can be replaced in a single online module change.

To replace multiple slice modules, perform a separate online module change for each module.

(6) Command execution during online module change

While an online module change is being executed (while the REL. LED of the head module is on), no command can be executed to the slice module being replaced online.

An attempt to execute a command in such a case will cause an error.

(7) Parameter change during online module change

To change a command parameter of the slice module, which is being replaced online (while the head module's REL. LED is on), from the master station, wait until the online module change is completed.

(8) The ERR. LED of the head module in online module change status

The ERR. LED of the head module in online module change status turns on only when an error related to the online module change occurs.

It will not turn on or flash when any other error occurs.

(9) I/O data during online module change

While an online module change is being executed for a slice module (while the REL. LED of the head module is on), all the Bit input area and Word input area data of the slice module are set to 0 (OFF).

(10) Mode used for online module change

Perform online module change in the normal mode.

(11) Forced output test during online module change

The forced output test of GX Configurator-ST cannot be used for the module being changed online.

After completion of the online module change, perform the forced output test.

7.2 Preparations for Online Module Change

Prepare GX Configurator-ST when replacing the ST1SS1 online.
Depending on the module failure status, command parameters may not be saved into the head module.

For the procedure for setting parameters during online module change, refer to the following.

 Section 7.4.1 When parameter setting is performed using GX Configurator-ST during online module change

When GX Configurator-ST is unavailable, make the preparations described below.
Without these preparations, data such as command parameters may not be imported to the new module when they cannot be saved to the head module.

(1) Command parameters

When GX Configurator-ST is unavailable, the command parameters must be set by commands after completion of online module change. Provide a command parameter setting program in the master station program.

For the command parameter setting program, refer to the following.

 Section 6.4 Program Examples

POINT

When GX Configurator-ST is unavailable, set the command parameters after operating the module once by default.

7.3 Disconnecting/Connecting the External Device for Online Module Change

Disconnect and connect the external device according to the following procedure.
Since power is supplied to the external device (SSI absolute encoder) from a power distribution module (ST1PSD/ST1PDD), disconnect and reconnect the power supply part by the switch or any other means.

(1) Disconnection

Disconnect the following part between the power distribution module and the external device (SSI absolute encoder).

Signal name + 24V (Terminal that supplies power to the SSI absolute encoder)

(2) Connection

Connect the following part between the power distribution module and the external device (SSI absolute encoder).

Signal name + 24V (Terminal that supplies power to the SSI absolute encoder)

7.4 Online Module Change Procedure

This section explains how to set command parameters during online module change when they could not be saved in the head module.

For other online module change procedures, refer to the following.

 MELSEC-ST CC-Link Head Module User's Manual, "4.6 Online Module Change Function"

7.4.1 When parameter setting is performed using GX Configurator-ST during online module change

This section describes the parameter setting procedure performed using GX Configurator-ST during online module change.

POINT

If a slice module different from the target one is selected by mistake, restart the operation by any of the following.

(1) On the screen shown in (c)

Click the button on screen (c) to terminate online module change.

(2) On the screen shown in (d)

Do not change the slice module, click the button, and perform the operations (g), (l), and (m) to complete the online module change once.

(3) During operation (g)

Mount the removed slice module again, click the button, and perform the operations (l) and (m) to complete the online module change once.

[Preparation for replacing ST1SS1]

(a) Select the ST1SS1 to be replaced online on the "System Monitor" screen.

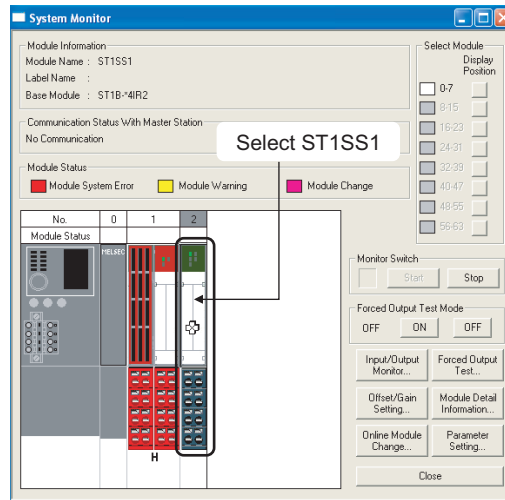

Figure 7.1 System Monitor screen

(b) Click the button on the "System Monitor" screen. Then, confirm that the RUN LED of the selected ST1SS1 is flashing at 0.25s intervals.

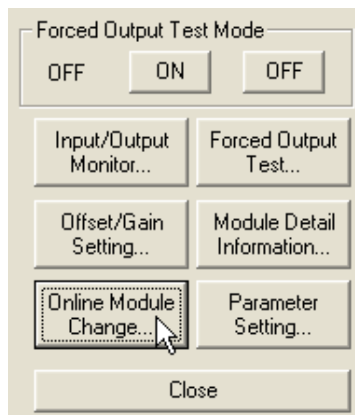

Figure 7.2 "Online Module Change" button

Remark

Instead of the above, the following operations are also available.

- Select [Diagnostics] → [Online Module Change].
- Right-click the ST1SS1 selected at step (a), and click [Online Module Change] on the menu.

- (c) Confirm that the ST1SS1 displayed as "Target Module" is the ST1SS1 to be replaced and click the button.

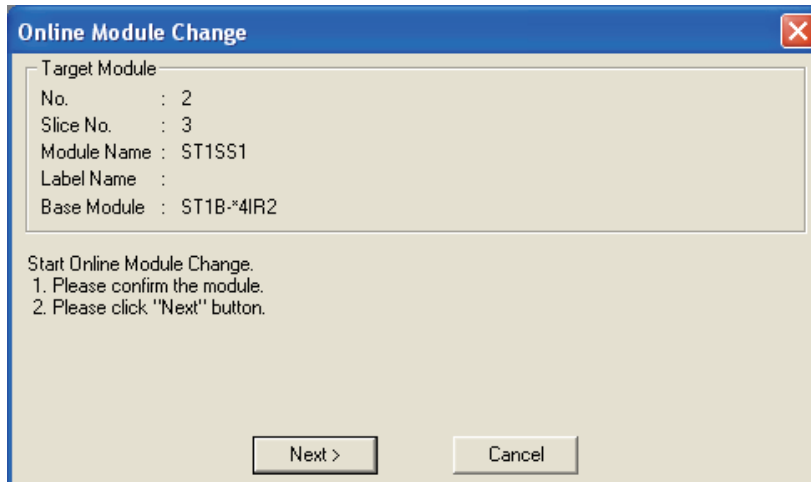

Figure 7.3 Online Module Change screen

- 1) Clicking the button validates the settings and the following will be performed.
 - The head module is placed into the online module change mode.
 - The command parameters of the ST1SS1 to be changed are saved into the head module.

Clicking the button stops online module change.

Clicking the button returns the screen back to the status before performing (b).
- 2) After clicking the button, confirm the following module states.
 - The REL. LED of the head module is on.
 - The RUN LED of the target ST1SS1 is off. (If any other LED has been on, it is off.)
 - The "Module Status" indicator of the target module has turned purple. This applies only when monitoring from the "System Monitor" screen.
- 3) If the command parameters could not be read from the ST1SS1, the REL. and ERR. LEDs of the head module turn on and an error message is displayed on the screen by the operation in step (g).
 Confirm the error and take corrective actions.
 For details of the error code reading and error codes of the head module, refer to the following.
 - ☞ MELSEC-ST CC-Link Head Module User's Manual, "9.7 Error Codes"
 To set parameters for the new ST1SS1, perform the operations described in (d) and later.

[Disconnection from external device]

- (d) When the left screen appears, cut off the power supply between the power distribution module on the immediate left of the ST1SS1 and the external device (SSI absolute encoder). For details, refer to the following.

☞ Section 7.3 Disconnecting/Connecting the External Device for Online Module Change

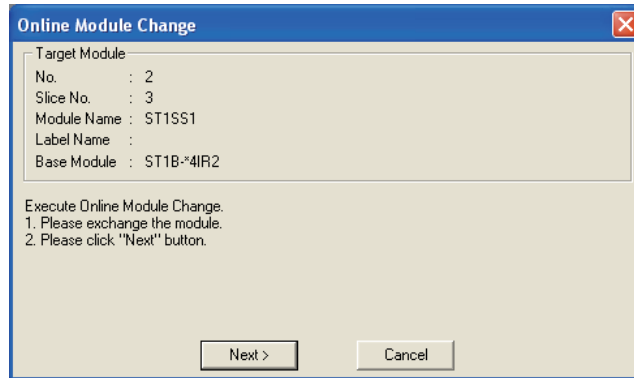

Figure 7.4 Disconnection from external device

☒ POINT

If the external device cannot be powered off, shut off all phases of the external power for the MELSEC-ST system and replace the ST1SS1.

[Replacing ST1SS1]

- (e) Remove the ST1SS1 and replace with a new one.

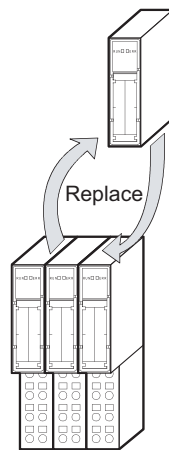

Figure 7.5 Replacing ST1SS1

[Connection of external device after replacement]

- (f) After installing a new ST1SS1, connect the power cable between the power distribution module and the external device (SSI absolute encoder).

[Operations after external device connection]

(g) After connecting the external device, click the button on the screen at step (d).

1) Clicking the button performs the following.

- Checking whether the model name of the newly mounted slice module is the same as that of the removed one.
- Writing the command parameters, which were saved in the head module in step (c), to the mounted ST1SS1.

Clicking the button stops online module change. Terminate the online module change by the following procedure.

- On the restarted screen shown in (a), select the same slice module. If a different module is selected, an error occurs.
- Perform the operation (b) to display the screen in (k), and click the button.

2) After clicking the button, confirm the following module status.

- The REL. LED of the head module is flashing.
- The RUN LED of the newly mounted ST1SS1 is flashing (at 0.25s intervals).

If the parameter settings could not be written to the ST1SS1, the REL. and ERR. LEDs of the head module turn on and the screen shown below appears.

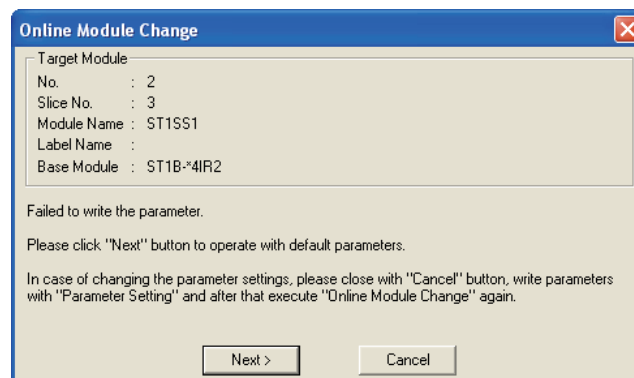

Figure 7.6 Error screen

Confirm the error and take corrective actions. (☞ Section 9.1 Error Code List)
For details of the error codes of the head module, refer to the following.

☞ MELSEC-ST CC-Link Head Module User's Manual, "9.7 Error Codes"

[Parameter setting]

- (h) Click the button to stop the online module change.

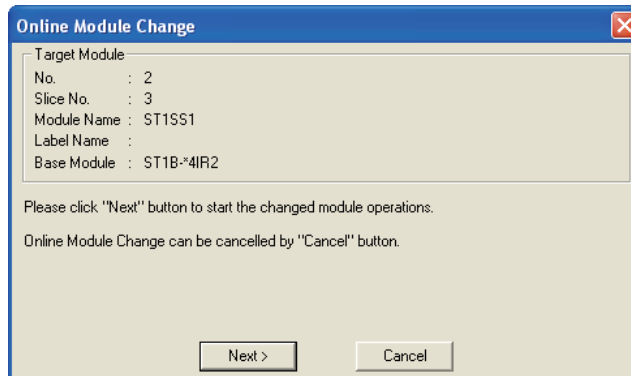

Figure 7.7 Stop of online module change

- (i) Click the button.



Figure 7.8 Confirmation dialog

- (j) Set parameters.

Take the procedures described in the following.

 Section 5.3 Parameter Setting

The following is the notes on parameter setting during online module change.

POINT

- (1) As the system is already in the diagnostic mode, the mode need not be changed.
- (2) When setting the parameters during an online module change, write them to both the RAM and ROM.
After the control resumes, the module will operate with the settings written on the RAM.
- (3) If the existing parameter settings could not be read from the old ST1SS1, the command parameters might have been written during operation (g).
Using GX Configurator-ST, check whether the command parameters have been written.

[Processing after parameter setting]

- (k) After setting parameters, execute the operations (a) and (b) to resume the online module change.

* Select the same ST1SS1 as the one selected before the online module change stop.
If the selected ST1SS1 is different, an error will occur.

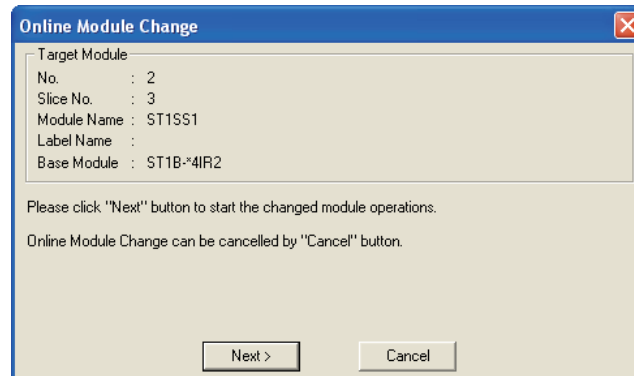

Figure 7.9 Online Module Change screen

- (l) Clicking the button releases the head module from the online module change mode.

- 1) Clicking the button results in the following.
- The head module exits the online module change mode.
 - I/O data refresh is restarted.

Clicking the button stops online module change.

When stopped, the screen in (a) is displayed.

Terminate the online module change by the following procedure.

- On the restarted screen shown in (a), select the same slice module. If a different module is selected, an error occurs.
- Follow the instructions in (b) to display the screen in (c), and click the button.

- 2) After clicking the button, confirm the following module status.
- The REL. LED of the head module is off.
 - The RUN LED of the newly mounted ST1SS1 is on.
 - The "Module Status" indicator of the target ST1SS1 has turned white on the "System Monitor" screen.

- 3) If the head module cannot exit the online module change mode, both the REL. and ERR. LEDs of the head module turn on.
Confirm the error and take corrective actions.

 MELSEC-ST CC-Link Head Module User's Manual, "9.7.2 Error code list"

[Completion]

(m) The following screen appears showing that online module change has been completed.

Click the button.

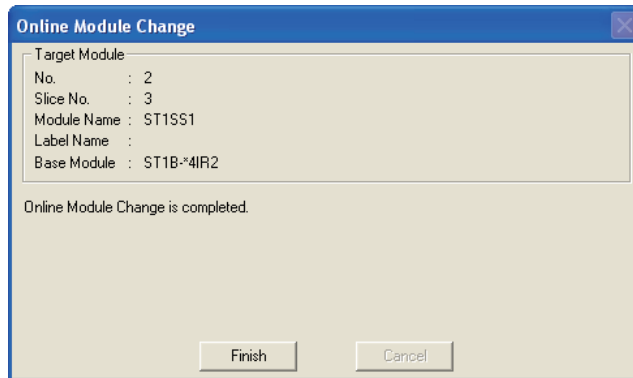

Figure 7.10 Completion of online module change

CHAPTER8 COMMANDS

This chapter explains the commands.

8.1 Command List

(1) About commands

A command is executed by transmitting a message to the MELSEC-ST system with a dedicated instruction (RDMSG) of the master station.

For the command execution procedure, refer to the following.

 MELSEC-ST CC-Link Head Module User's Manual, "8.1 Command execution method and procedures"

(2) When two command numbers are assigned to one command

Use command number 8000H or higher.

Commands, with the number 7FFFH and smaller, are used for importing existing sequence programs from the ST1H-PB (MELSEC-ST PROFIBUS-DP head module) to the ST1H-BT (MELSEC-ST CC-Link head module).

(3) Command list

The list of commands that are executable in the ST1SS1 and conditions for respective command executions are shown on the following pages.

Table 8.1 Command list

Command type	Command		Description	Execution condition	Reference section
	Command No.	Command name			
Common command	8100H 0100H	Operating status read request	Reads the operating status of the ST1SS1.	-	Section 8.2.1
	8101H 0101H	Error code read request	Reads an error code of the ST1SS1.	-	Section 8.2.2
Initial data write command	8106H	Initial data batch write request	Writes command parameters to multiple ST1SS1s all at once.	Bw.n+1 Executable only when "Bw.n+1" Convert setting request is OFF (0).	Section 8.3.1
	8107H 0107H	Initial data individual write request	Writes command parameters to a single ST1SS1.		Section 8.3.2
ST1SS1 parameter setting read command	9500H 1500H	Initial data setting read	Reads initial data from RAM of the ST1SS1.	-	Section 8.4.1
	9501H 1501H	SSI trailing bits setting read	Reads SSI trailing bits setting from RAM of the ST1SS1.	-	Section 8.4.2
	9502H 1502H	SSI monoflop time setting read	Reads SSI monoflop time setting from RAM of the ST1SS1.	-	Section 8.4.3
	9503H 1503H	Latch mode setting read	Reads latch mode setting from RAM of the ST1SS1.	-	Section 8.4.4
	9504H 1504H	Coincidence detection flag setting read	Reads coincidence detection setting from RAM of the ST1SS1.	-	Section 8.4.5
	9505H 1505H	Coincidence detection value read	Reads coincidence detection values from RAM of the ST1SS1.	-	Section 8.4.6
ST1SS1 parameter setting write command	A501H 2501H	SSI trailing bits setting write	Writes SSI trailing bits setting to RAM of the ST1SS1.	Bw.n+1 Executable only when "Bw.n+1" Convert setting request is OFF (0).	Section 8.5.1
	A502H 2502H	SSI monoflop time setting write	Writes SSI monoflop time setting to RAM of the ST1SS1.		Section 8.5.2
	A503H 2503H	Latch mode setting write	Writes latch mode setting to RAM of the ST1SS1.		Section 8.5.3
	A504H 2504H	Coincidence detection flag setting write	Writes coincidence detection setting to RAM of the ST1SS1.		Section 8.5.4
	A505H 2505H	Coincidence detection value write	Writes coincidence detection values to RAM of the ST1SS1.		Section 8.5.5
ST1SS1 control command	B500H 3500H	Parameter setting read from ROM	Reads parameters from ROM to RAM in the ST1SS1.		Section 8.6.1
	B501H 3501H	Parameter setting write to ROM	Writes parameters from RAM to ROM in the ST1SS1.		Section 8.6.2

POINT

If a command execution is attempted while the required condition does not meet, it will fail and "06H" or "13H" will be stored in Cr.n(15-8) Command execution result.

8.2 Common Commands

8.2.1 Operating status read request (Command No.: 8100H/0100H)

Data size	
Cw	4 words (8 bytes)
Cr	4 words (8 bytes)

This command reads the operating status of the ST1SS1.

(1) Values set to "Cw" Command execution area

Table 8.2 Values set to "Cw" Command execution area

Cw Command execution area	Setting value
Cw.0	[For execution of command No.8100H] Set a slice position No. of the target ST1SS1. (Hexadecimal) [For execution of command No.0100H] Set a start slice No. of the target ST1SS1. (Hexadecimal)
Cw.1	Set a command No. to be executed (8100H/0100H). (Hexadecimal)
Cw.2	Fixed to 0000H. (Any other value is treated as 0000H.)
Cw.3	

(2) Values stored in "Cr" Command result area

The command execution result data vary depending on the result data (normal completion or failure) in Cr.0(15-8) Command execution result.

(a) When completed normally ("Cr.0(15-8)" Command execution result is 00H.)

Table 8.3 Values stored in "Cr" Command result area (When completed normally)

Cr Command result area	Result details
Cr.0	[For execution of command No.8100H] The command execution result and slice position No. in hexadecimal are stored in the high and low bytes respectively as shown below. <div style="text-align: center;"> </div>
	[For execution of command No.0100H] The command execution result and start slice No. in hexadecimal are stored in the high and low bytes respectively as shown below <div style="text-align: center;"> </div>
Cr.1	The executed command No. (8100H/0100H) is stored. (Hexadecimal)

Table 8.3 Values stored in "Cr" Command result area (When completed normally) (Continued)

Cr	Command result area	Result details
		The operating status of the ST1SS1 is stored.
	Cr.2	
	Cr.3	The operation mode of the ST1SS1, 0001H (Normal mode), is stored.

(b) When failed ("Cr.0(15-8)" Command execution result is other than 00H.)

Table 8.4 Values stored in "Cr" Command result area (When failed)

Cr	Command result area	Result details
		[For execution of command No.8100H] The command execution result and slice position No. in hexadecimal are stored in the high and low bytes respectively as shown below
	Cr.0	
		[For execution of command No.0100H] The command execution result and start slice No. in hexadecimal are stored in the high and low bytes respectively as shown below.
	Cr.0	
	Cr.1	The executed command No. (8100H/0100H) is stored. (Hexadecimal)
	Cr.2	Cw.2 Argument 1 at command execution is stored.
	Cr.3	Cw.3 Argument 2 at command execution is stored.

* 1 When 0FH is stored in Cr.0(15-8) Command execution result, 00H (slice position No. or start slice No. of the head module) is stored in Cr.0(7-0) Start slice No. or Slice position No.

8.2.2 Error code read request (Command No.: 8101H/0101H)

Data size	
Cw	4 words (8 bytes)
Cr	4 words (8 bytes)

This command reads an error code of the ST1SS1.

(1) Values set to "Cw" Command execution area

Table 8.5 Values set to "Cw" Command execution area

Cw	Command execution area	Setting value
Cw.0		[For execution of command No.8101H] Set a slice position No. of the target ST1SS1. (Hexadecimal)
		[For execution of command No.0101H] Set a start slice No. of the target ST1SS1. (Hexadecimal)
Cw.1		Set a command No. to be executed (8101H/0101H). (Hexadecimal)
Cw.2		Fixed to 0000H. (Any other value is treated as 0000H.)
Cw.3		

(2) Values stored in "Cr" Command result area

The command execution result data vary depending on the result data (normal completion or failure) in Cr.0(15-8) Command execution result.

(a) When completed normally ("Cr.0(15-8)" Command execution result is 00H.)

Table 8.6 Values stored in "Cr" Command result area (When completed normally)

Cr	Command result area	Result details
Cr.0		[For execution of command No.8101H] The command execution result and slice position No. in hexadecimal are stored in the high and low bytes respectively as shown below. <div style="text-align: center;"> <p style="text-align: center;">b15 ~ b8 b7 ~ b0</p> <p style="text-align: center;">Cr.0(15-8) Command execution result Cr.0(7-0) Slice position No.</p> <p style="text-align: center;">→ 00H: Normal completion</p> </div>
		[For execution of command No.0101H] The command execution result and start slice No. in hexadecimal are stored in the high and low bytes respectively as shown below. <div style="text-align: center;"> <p style="text-align: center;">b15 ~ b8 b7 ~ b0</p> <p style="text-align: center;">Cr.0(15-8) Command execution result Cr.0(7-0) Start slice No.</p> <p style="text-align: center;">→ 00H: Normal completion</p> </div>
Cr.1		The executed command No. (8101H/0101H) is stored. (Hexadecimal)

Table 8.6 Values stored in "Cr" Command result area (When completed normally) (Continued)

Cr	Command result area	Result details
	Cr.2	The error code of the error that is currently occurring in the ST1SS1 is stored. (Hexadecimal) For details of error codes, refer to the following. ☞ Section 9.1 Error Code List When no error is detected, 0000H is stored.
	Cr.3	0000H is stored.

(b) When failed ("Cr.0(15-8)" Command execution result is other than 00H.)

Table 8.7 Values stored in "Cr" Command result area (When failed)

Cr	Command result area	Result details
	Cr.0	<p>[For execution of command No.8101H] The command execution result and slice position No. in hexadecimal are stored in the high and low bytes respectively as shown below.</p> <div style="text-align: center;"> <p>b15 ~ b8 b7 ~ b0</p> <p>Cr.0(15-8) Command execution result Cr.0(7-0) Slice position No.*1</p> <p>☞ Other than 00H: Failure (☞ Section 8.7 Values Stored into Command Execution Result)</p> </div> <p>[For execution of command No.0101H] The command execution result and start slice No. in hexadecimal are stored in the high and low bytes respectively as shown below.</p> <div style="text-align: center;"> <p>b15 ~ b8 b7 ~ b0</p> <p>Cr.0(15-8) Command execution result Cr.0(7-0) Start slice No.*1</p> <p>☞ Other than 00H: Failure (☞ Section 8.7 Values Stored into Command Execution Result)</p> </div>
	Cr.1	The executed command No. (8101H/0101H) is stored. (Hexadecimal)
	Cr.2	Cw.2 Argument 1 at command execution is stored
	Cr.3	Cw.3 Argument 2 at command execution is stored.

* 1 When 0FH is stored in Cr.0(15-8) Command execution result, 00H (slice position No. or start slice No. of the head module) is stored in Cr.0(7-0) Start slice No. or Slice position No.

8.3 Initial Data Write Command

8.3.1 Initial data batch write request (Command No.: 8106H)

Data size	
Cw	6 to 20 words (12 to 40 bytes)
Cr	6 words (12 bytes)

This command batch-writes command parameters to the following modules of the same type.

- Head module
- Input module
- Output module
- Intelligent function module

Command parameters are written to RAMs of multiple ST1SS1s all at once.

(1) Values set to "Cw" Command execution area

Table 8.8 Values set to "Cw" Command execution area

Cw	Command execution area	Setting value
Cw.0		Fixed to 0000H.
Cw.1		Set a command No. to be executed (8106H). (Hexadecimal)
Cw.2		Set command parameters of the head module. (Hexadecimal)* ¹
Cw.3		Set command parameters of input modules. (Hexadecimal)* ¹
Cw.4		Set command parameters of output modules. (Hexadecimal)* ¹
Cw.5		Set the number of the command parameter settings for intelligent function modules in Cw.6 to Cw.19 (number of module types: 0 to 7).
Cw.6		Set a number specific to the ST1SS1 module and command parameters. (Hexadecimal) This setting is required only when one or more value is set in Cw.5. <div style="text-align: center; margin-top: 10px;"> <p>Module-specific No. (bits b3, b2, b1, b0)</p> <p>SSi baud rate setting 000: 125kHz 001: 250kHz 010: 500kHz 011: 1MHz 100: 2MHz</p> <p>SSi direction reversal setting 0: No reversal 1: Reversal</p> </div>

Table 8.8 Values set to "Cw" Command execution area (Continued)

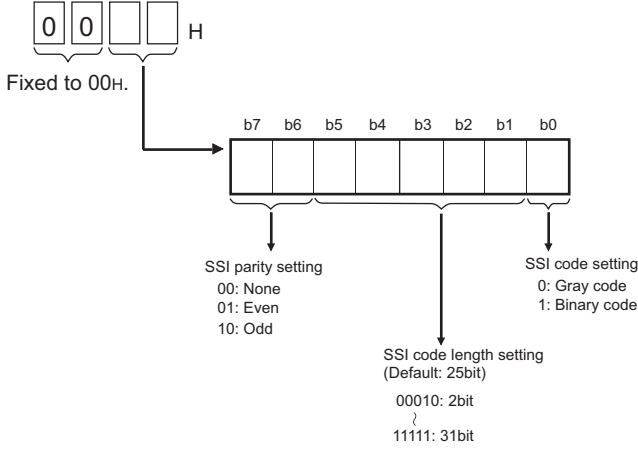
Cw	Command execution area	Setting value
	Cw.7	Set command parameters of the ST1SS1. (Hexadecimal) This setting is required only when one or more value is set in Cw.5 . <div style="text-align: center;">  </div>
	Cw.8 to Cw.19	In the same way as in Cw.6 or Cw.7 , set command parameters for other ST1SS1s and intelligent function modules. (Two words each)*2

* 1 For settings of each module, refer to the following.

➔ MELSEC-ST CC-Link Head Module User's Manual, "8.2.7 Initial data batch write request (Command No.: 8106H)"

* 2 For settings of intelligent function modules other than the ST1SS1, refer to the following.

➔ Intelligent Function Module User's Manual, "Initial data batch write request (Command No.: 8106H)"

(2) Values stored in "Cr" Command result area

The command execution result data vary depending on the data (normal completion or failure) in Cr.0.

(a) When completed normally ("Cr.0" is 0000H.)

Table 8.9 Values stored in "Cr" Command result area (When completed normally)

Cr	Command result area	Result details																																																																																					
	Cr.0	Error code (0000H when completed normally)																																																																																					
	Cr.1	The executed command No. (8106H) is stored. (Hexadecimal)																																																																																					
	Cr.2	The command parameter setting status after writing is stored for each slice module.																																																																																					
	Cr.3	<table border="1" style="margin-left: auto; margin-right: auto;"> <thead> <tr> <th></th> <th>b15</th><th>b14</th><th>b13</th><th>b12</th><th>b11</th><th>b10</th><th>b9</th><th>b8</th><th>b7</th><th>b6</th><th>b5</th><th>b4</th><th>b3</th><th>b2</th><th>b1</th><th>b0</th> </tr> </thead> <tbody> <tr> <td style="border: 1px solid black;">Cr.2</td> <td>15</td><td>14</td><td>13</td><td>12</td><td>11</td><td>10</td><td>9</td><td>8</td><td>7</td><td>6</td><td>5</td><td>4</td><td>3</td><td>2</td><td>1</td><td>0</td> </tr> <tr> <td style="border: 1px solid black;">Cr.3</td> <td>31</td><td>30</td><td>29</td><td>28</td><td>28</td><td>26</td><td>25</td><td>24</td><td>23</td><td>22</td><td>21</td><td>20</td><td>19</td><td>18</td><td>17</td><td>16</td> </tr> <tr> <td style="border: 1px solid black;">Cr.4</td> <td>47</td><td>46</td><td>45</td><td>44</td><td>43</td><td>42</td><td>41</td><td>40</td><td>39</td><td>38</td><td>37</td><td>36</td><td>35</td><td>34</td><td>33</td><td>32</td> </tr> <tr> <td style="border: 1px solid black;">Cr.5</td> <td>63</td><td>62</td><td>61</td><td>60</td><td>59</td><td>58</td><td>57</td><td>56</td><td>55</td><td>54</td><td>53</td><td>52</td><td>51</td><td>50</td><td>49</td><td>48</td> </tr> </tbody> </table> <p style="margin-left: 200px;">← Each bit indicates each slice position No.</p> <p style="text-align: right; margin-right: 50px;">0: Parameter not set 1: Parameter set</p>		b15	b14	b13	b12	b11	b10	b9	b8	b7	b6	b5	b4	b3	b2	b1	b0	Cr.2	15	14	13	12	11	10	9	8	7	6	5	4	3	2	1	0	Cr.3	31	30	29	28	28	26	25	24	23	22	21	20	19	18	17	16	Cr.4	47	46	45	44	43	42	41	40	39	38	37	36	35	34	33	32	Cr.5	63	62	61	60	59	58	57	56	55	54	53	52	51	50	49	48
	b15		b14	b13	b12	b11	b10	b9	b8	b7	b6	b5	b4	b3	b2	b1	b0																																																																						
Cr.2	15		14	13	12	11	10	9	8	7	6	5	4	3	2	1	0																																																																						
Cr.3	31		30	29	28	28	26	25	24	23	22	21	20	19	18	17	16																																																																						
Cr.4	47		46	45	44	43	42	41	40	39	38	37	36	35	34	33	32																																																																						
Cr.5	63	62	61	60	59	58	57	56	55	54	53	52	51	50	49	48																																																																							
	Cr.4																																																																																						
	Cr.5																																																																																						

(b) When failed ("Cr.0" is other than 0000H.)

Table 8.10 Values stored in "Cr" Command result area (When failed)

Cr	Command result area	Result details																																																																																					
	Cr.0	An error code is stored. (Hexadecimal)* ¹																																																																																					
	Cr.1	The executed command No. (8106H) is stored. (Hexadecimal)																																																																																					
	Cr.2	The command parameter setting status after writing is stored for each slice module.																																																																																					
	Cr.3																																																																																						
	Cr.4																																																																																						
	Cr.5																																																																																						
	Cr.5																																																																																						
		<table border="1"> <thead> <tr> <th></th> <th>b15</th><th>b14</th><th>b13</th><th>b12</th><th>b11</th><th>b10</th><th>b9</th><th>b8</th><th>b7</th><th>b6</th><th>b5</th><th>b4</th><th>b3</th><th>b2</th><th>b1</th><th>b0</th> </tr> </thead> <tbody> <tr> <td>Cr.2</td> <td>15</td><td>14</td><td>13</td><td>12</td><td>11</td><td>10</td><td>9</td><td>8</td><td>7</td><td>6</td><td>5</td><td>4</td><td>3</td><td>2</td><td>1</td><td>0</td> </tr> <tr> <td>Cr.3</td> <td>31</td><td>30</td><td>29</td><td>28</td><td>28</td><td>26</td><td>25</td><td>24</td><td>23</td><td>22</td><td>21</td><td>20</td><td>19</td><td>18</td><td>17</td><td>16</td> </tr> <tr> <td>Cr.4</td> <td>47</td><td>46</td><td>45</td><td>44</td><td>43</td><td>42</td><td>41</td><td>40</td><td>39</td><td>38</td><td>37</td><td>36</td><td>35</td><td>34</td><td>33</td><td>32</td> </tr> <tr> <td>Cr.5</td> <td>63</td><td>62</td><td>61</td><td>60</td><td>59</td><td>58</td><td>57</td><td>56</td><td>55</td><td>54</td><td>53</td><td>52</td><td>51</td><td>50</td><td>49</td><td>48</td> </tr> </tbody> </table> <p style="text-align: right;">← Each bit indicates each slice position No.</p> <p style="text-align: right;">0: Parameter not set 1: Parameter set</p>		b15	b14	b13	b12	b11	b10	b9	b8	b7	b6	b5	b4	b3	b2	b1	b0	Cr.2	15	14	13	12	11	10	9	8	7	6	5	4	3	2	1	0	Cr.3	31	30	29	28	28	26	25	24	23	22	21	20	19	18	17	16	Cr.4	47	46	45	44	43	42	41	40	39	38	37	36	35	34	33	32	Cr.5	63	62	61	60	59	58	57	56	55	54	53	52	51	50	49	48
	b15	b14	b13	b12	b11	b10	b9	b8	b7	b6	b5	b4	b3	b2	b1	b0																																																																							
Cr.2	15	14	13	12	11	10	9	8	7	6	5	4	3	2	1	0																																																																							
Cr.3	31	30	29	28	28	26	25	24	23	22	21	20	19	18	17	16																																																																							
Cr.4	47	46	45	44	43	42	41	40	39	38	37	36	35	34	33	32																																																																							
Cr.5	63	62	61	60	59	58	57	56	55	54	53	52	51	50	49	48																																																																							

* 1 For details of error codes, refer to the following.

 MELSEC-ST CC-Link Head Module User's Manual, "9.7.2 Error code list"

POINT

- (1) In to , intelligent function module's command parameter settings exceeding the quantity set in are not executed.
- (2) Initial data batch write request (Command No.: 8106H) cannot be executed with another command at the same time.
Doing so will cause an error.

8.3.2 Initial data individual write request (Command No.: 8107H/0107H)

Data size	
Cw	6 to 99 words (12 to 198 bytes)
Cr	4 to 35 words (8 to 70 bytes)

This command writes command parameters of the following modules to RAM for each module.

- Head module
- Input module
- Output module
- Intelligent function module

Command parameters are written to RAM of a single ST1SS1.

(1) Values set to "Cw" Command execution area

Table 8.11 Values set to "Cw" Command execution area

Cw	Command execution area	Setting value
	Cw.0	Fixed to 0000H.
	Cw.1	Set a command No. to be executed (8107H/0107H). (Hexadecimal)
	Cw.2	Set the number of the command parameter settings for slice modules (number of the modules: 1 to 32). (Hexadecimal)
	Cw.3	[For execution of command No.8107H] Set a slice position No. of the target ST1SS1. (Hexadecimal)
		[For execution of command No.0107H] Set a start slice No. of the target ST1SS1. (Hexadecimal)
	Cw.4	Set a number specific to the ST1SS1 module and command parameters. (Hexadecimal) <div style="text-align: center; margin-top: 10px;"> <p>Module-specific No. (bits 8, 6, 0) and bits b3, b2, b1, b0.</p> <p>SSI baud rate setting: 000: 125kHz 001: 250kHz 010: 500kHz 011: 1MHz 100: 2MHz</p> <p>SSI direction reversal setting: 0: No reversal 1: Reversal</p> </div>

Table 8.11 Values set to "Cw" Command execution area (Continued)

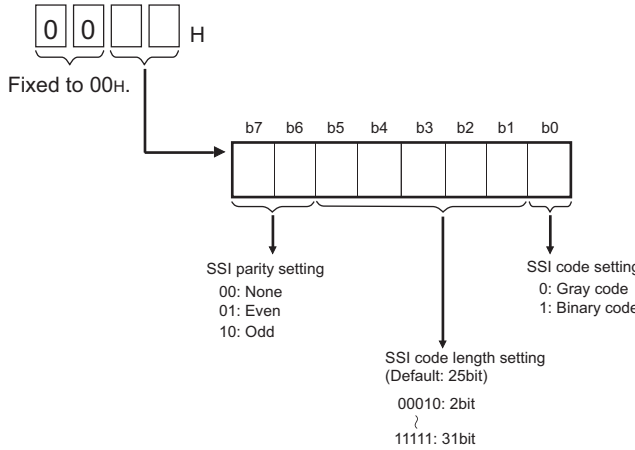
Cw Command execution area	Setting value
Cw.5	<p>Set respective command parameters for the ST1SS1. (Hexadecimal)</p> <div style="text-align: center;">  </div>
Cw.6 to Cw.98	<p>In the same way as in Cw.3 to Cw.5, set command parameters for each module. (Three words each)*1</p>

* 1 For settings of the head module and I/O modules, refer to the following.

➡ MELSEC-ST CC-Link Head Module User's Manual, "8.2.8 Initial data individual write request (Command No.: 8107H/0107H)"

For settings of intelligent function modules other than the ST1SS1, refer to the following.

➡ Intelligent Function Module User's Manual, "Initial data individual write request (Command No.: 8107H/0107H)"

(2) Values stored in "Cr" Command result area

The command execution result data vary depending on the data (normal completion or failure) in Cr.0.

(a) When completed normally ("Cr.0" is 0000H.)

Table 8.12 Values stored in "Cr" Command result area (When completed normally)

Cr Command result area	Result details
Cr.0	Error code (0000H when completed normally)
Cr.1	The executed command No. (8107H/0107H) is stored. (Hexadecimal)
Cr.2	The number of command parameter settings of the intelligent function module is stored.
Cr.3	<p>[For execution of command No.8107H] The command execution result and slice position No. in hexadecimal are stored in the high and low bytes respectively as shown below.</p> <div style="text-align: center;">  </div> <p>[For execution of command No.0107H] The command execution result and start slice No. in hexadecimal are stored in the high and low bytes respectively as shown below</p> <div style="text-align: center;">  </div>

Table 8.12 Values stored in "Cr" Command result area (When completed normally)

Cr	Command result area	Result details
	Cr.4 to Cr.34	Detailed results for the intelligent function modules set in Cr.2 are stored in the same way as in Cr.3. (One word each)

(b) When failed ("Cr.0" is other than 0000H.)

Table 8.13 Values stored in "Cr" Command result area (When failed)

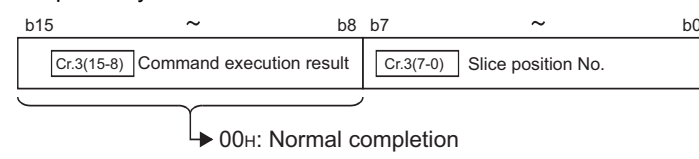
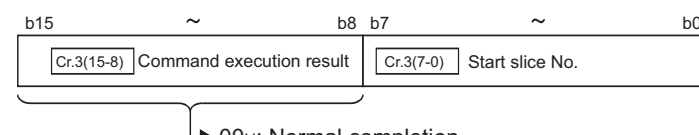
Cr	Command result area	Result details
	Cr.0	An error code is stored. (Hexadecimal)* ¹
	Cr.1	The executed command No. (8107H/0107H) is stored. (Hexadecimal)
	Cr.2	The number of command parameter settings of the intelligent function module is stored.
	Cr.3	<p>[For execution of command No.8107H]</p> <p>The command execution result and slice position No. in hexadecimal are stored in the high and low bytes respectively as shown below.</p> <div style="text-align: center;"> <p style="text-align: center;">Other than 00H: Failure (Hand icon) Section 8.7 Values Stored into Command Execution Result</p> </div> <p>[For execution of command No.0107H]</p> <p>The command execution result and start slice No. in hexadecimal are stored in the high and low bytes respectively as shown below.</p> <div style="text-align: center;"> <p style="text-align: center;">Other than 00H: Failure (Hand icon) Section 8.7 Values Stored into Command Execution Result</p> </div>
		Cr.4 to Cr.34

* 1 For details of error codes, refer to the following.

(Hand icon) MELSEC-ST CC-Link Head Module User's Manual, "9.7.2 Error code list"

* 2 When 0FH is stored in Cr.3(15-8) Command execution result, 00H (slice position No. or start slice No. of the head module) is stored in Cr.3(7-0) Slice position No. or start slice No.

POINT

- (1) Cw.3 to Cw.98, intelligent function module's command parameter settings exceeding the quantity set in Cw.2 are not executed.
- (2) Initial data individual write request (Command No.: 8107H/0107H) cannot be executed with another command at the same time.
Doing so will cause an error.
- (3) When the slice position No. or start slice No. is duplicated, the module with the duplicate setting is detected as an error module.

8.4 ST1SS1 Parameter Setting Read Commands

8.4.1 Initial data setting read (Command No.: 9500H/1500H)

Data size	
Cw	4 words (8 bytes)
Cr	4 words (8 bytes)

This command reads the SSI code setting, SSI code length setting, SSI parity setting, SSI baud rate setting, and SSI direction reversal setting from RAM of the ST1SS1.

(1) Values set to "Cw" Command execution area

Table 8.14 Values set to "Cw" Command execution area

Cw Command execution area	Setting value
Cw.0	[For execution of command No.9500H] Set a slice position No. of the target ST1SS1. (Hexadecimal) [For execution of command No.1500H] Set a start slice No. of the target ST1SS1. (Hexadecimal)
Cw.1	Set a command No. to be executed (9500H/1500H). (Hexadecimal)
Cw.2	Fixed to 0000H. (Any other value is treated as 0000H.)
Cw.3	

(2) Values stored in "Cr" Command result area

The command execution result data vary depending on the result data (normal completion or failure) in Cr.0(15-8) Command execution result.

(a) When completed normally ("Cr.0(15-8)" Command execution result is 00H.)

Table 8.15 Values stored in "Cr" Command result area (When completed normally)

Cr Command result area	Result details
Cr.0	[For execution of command No.9500H] The command execution result and slice position No. in hexadecimal are stored in the high and low bytes respectively as shown below <div style="text-align: center;"> </div>
	[For execution of command No.1500H] The command execution result and start slice No. in hexadecimal are stored in the high and low bytes respectively as shown below. <div style="text-align: center;"> </div>
Cr.1	The executed command No. (9500H/1500H) is stored. (Hexadecimal)

Table 8.15 Values stored in "Cr" Command result area (When completed normally) (Continued)

Cr	Command result area	Result details																										
		<p>The SSI code setting, SSI code length setting, SSI parity setting, SSI baud rate setting, and SSI direction reversal setting in RAM are stored.</p> <table border="1" style="margin-left: auto; margin-right: auto;"> <tr> <td>b15</td> <td>~</td> <td>b12</td> <td>b11</td> <td>b10</td> <td>~</td> <td>b8</td> <td>b7</td> <td>b6</td> <td>b5</td> <td>~</td> <td>b1</td> <td>b0</td> </tr> <tr> <td colspan="3">Fixed to 0.</td> <td colspan="2">5)</td> <td colspan="2">4)</td> <td colspan="2">3)</td> <td colspan="3">2)</td> <td colspan="1">1)</td> </tr> </table> <p>1) SSI code setting (b0) 0: Gray code 1: Binary code</p> <p>2) SSI code length setting (b1 to b5) 2 to 31 (bit)</p> <p>3) SSI parity setting (b6 to b7) 00: None 01: Even 10: Odd</p> <p>4) SSI baud rate setting (b8 to b10) 000: 125kHz 001: 250kHz 010: 500kHz 011: 1MHz 100: 2MHz</p> <p>5) SSI direction reversal setting (b11) 0: No reversal 1: Reversal</p>	b15	~	b12	b11	b10	~	b8	b7	b6	b5	~	b1	b0	Fixed to 0.			5)		4)		3)		2)			1)
b15	~	b12	b11	b10	~	b8	b7	b6	b5	~	b1	b0																
Fixed to 0.			5)		4)		3)		2)			1)																
	Cr.2 *1																											
	Cr.3 *1	<p>The currently valid values of the SSI code setting, SSI code length setting, SSI parity setting, SSI baud rate setting, and SSI direction reversal setting are stored. The stored values are the same as those in "Cr.2" Response data 1.</p>																										

*1 If the stored values differ between Cr.2 and Cr.3, the parameters written to the RAM with the command have not taken effect in the module. Set Bw.n+1 Convert setting request to ON (1) for the parameters on the RAM to take effect in the module.

(b) When failed ("Cr.0(15-8)" Command execution result is other than 00H.)

Table 8.16 Values stored in "Cr" Command result area (When failed)

Cr	Command result area	Result details												
		<p>[For execution of command No.9500H] The command execution result and slice position No. in hexadecimal are stored in the high and low bytes respectively as shown below</p> <table border="1" style="margin-left: auto; margin-right: auto;"> <tr> <td>b15</td> <td>~</td> <td>b8</td> <td>b7</td> <td>~</td> <td>b0</td> </tr> <tr> <td colspan="4">Cr.0(15-8) Command execution result</td> <td colspan="2">Cr.0(7-0) Slice position No. *1</td> </tr> </table> <p>Other than 00H: Failure (☞ Section 8.7 Values Stored into Command Execution Result)</p>	b15	~	b8	b7	~	b0	Cr.0(15-8) Command execution result				Cr.0(7-0) Slice position No. *1	
b15	~	b8	b7	~	b0									
Cr.0(15-8) Command execution result				Cr.0(7-0) Slice position No. *1										
	Cr.0													
		<p>[For execution of command No.1500H] The command execution result and start slice No. in hexadecimal are stored in the high and low bytes respectively as shown below.</p> <table border="1" style="margin-left: auto; margin-right: auto;"> <tr> <td>b15</td> <td>~</td> <td>b8</td> <td>b7</td> <td>~</td> <td>b0</td> </tr> <tr> <td colspan="4">Cr.0(15-8) Command execution result</td> <td colspan="2">Cr.0(7-0) Start slice No. *1</td> </tr> </table> <p>Other than 00H: Failure (☞ Section 8.7 Values Stored into Command Execution Result)</p>	b15	~	b8	b7	~	b0	Cr.0(15-8) Command execution result				Cr.0(7-0) Start slice No. *1	
b15	~	b8	b7	~	b0									
Cr.0(15-8) Command execution result				Cr.0(7-0) Start slice No. *1										
	Cr.1	The executed command No. (9500H/1500H) is stored. (Hexadecimal)												
	Cr.2	Cw.2 Argument 1 at command execution is stored.												
	Cr.3	Cw.3 Argument 2 at command execution is stored.												

* 1 When 0FH is stored in Cr.0(15-8) Command execution result, 00H (slice position No. or start slice No. of the head module) is stored in Cr.0(7-0) Slice position No. or start slice No.

8.4.2 SSI trailing bits setting read (Command No.: 9501H/1501H)

Data size	
Cw	4 words (8 bytes)
Cr	4 words (8 bytes)

This command reads the SSI trailing bits setting from RAM of the ST1SS1.

(1) Values set to "Cw" Command execution area

Table 8.17 Values set to "Cw" Command execution area

Cw	Command execution area	Setting value
Cw.0		[For execution of command No.959101H] Set a slice position No. of the target ST1SS1. (Hexadecimal)
		[For execution of command No.1501H] Set a start slice No. of the target ST1SS1. (Hexadecimal)
Cw.1		Set a command No. to be executed (959101H/151101H). (Hexadecimal)
Cw.2		Fixed to 0000H. (Any other value is treated as 0000H.)
Cw.3		

(2) Values stored in "Cr" Command result area

(a) When completed normally ("Cr.0(15-8)" Command execution result is 00H.)

Table 8.18 Values stored in "Cr" Command result area (When completed normally)

Cr	Command result area	Setting value
Cr.0		For execution of command No.9501H The command execution result and slice position No. in hexadecimal are stored in the high and low bytes respectively as shown below. <div style="text-align: center;"> <p>b15 ~ b8 b7 ~ b0</p> <p>Cr.0(15-8) Command execution result Cr.0(7-0) Slice position No.</p> <p>→ 00H: Normal completion</p> </div>
		[For execution of command No.1501H] The command execution result and start slice No. in hexadecimal are stored in the high and low bytes respectively as shown below <div style="text-align: center;"> <p>b15 ~ b8 b7 ~ b0</p> <p>Cr.0(15-8) Command execution result Cr.0(7-0) Start slice No.</p> <p>→ 00H: Normal completion</p> </div>
Cr.1		The executed command No. (9501H/1501H) is stored. (Hexadecimal)
Cr.2		The SSI trailing bits setting is stored. <div style="text-align: center;"> <p>0 0 0 0 H</p> <p>Fixed to 0.</p> <p>→ SSI trailing bits setting</p> <p>0H: 0bit ? FH: 15bit</p> </div>
Cr.3		0000H is stored.

(b) When failed ("Cr.0(15-8)" Command execution result is other than 00H.

Table 8.19 Values stored in "Cr" Command result area (When failed)

Cr	Command result area	Result details
Cr.0		<p>[For execution of command No.9501H]</p> <p>The command execution result and slice position No. in hexadecimal are stored in the high and low bytes respectively as shown below.</p> <div style="text-align: center;"> </div>
		<p>[For execution of command No.1501H]</p> <p>The command execution result and start slice No. in hexadecimal are stored in the high and low bytes respectively as shown below.</p> <div style="text-align: center;"> </div>
	Cr.1	The executed command No. (9501H/1501H) is stored. (Hexadecimal)
	Cr.2	Cr.w.2 Argument 1 at command execution is stored.
Cr.3	Cr.w.3 Argument 2 at command execution is stored.	

* 1 When 0FH is stored in Cr.0(15-8) Command execution result, 00H (slice position No. or start slice No. of the head module) is stored in Cr.0(7-0) Slice position No. or start slice No.

8.4.3 SSI monoflop time setting read (Command No.: 9502H/1502H)

Data size	
Cw	4 words (8 bytes)
Cr	4 words (8 bytes)

This command reads the SSI monoflop time setting from RAM of the ST1SS1.

(1) Values set to "Cw" Command execution area

Table 8.20 Values set to "Cw" Command execution area

Cw	Command execution area	Setting value
Cw.0	Cw.0	[For execution of command No.9502H] Set a slice position No. of the target ST1SS1. (Hexadecimal)
		[For execution of command No.1502H] Set a start slice No. of the target ST1SS1. (Hexadecimal)
Cw.1	Cw.1	Set a command No. to be executed (9502H/1502H). (Hexadecimal)
Cw.2	Cw.2	Fixed to 0000H. (Any other value is treated as 0000H.)
Cw.3	Cw.3	

(2) Values stored in "Cr" Command result area

(a) When completed normally ("Cr.0(15-8)" Command execution result is 00H.)

Table 8.21 Values stored in "Cr" Command result area (When completed normally)

Cr	Command result area	Result details
Cr.0	Cr.0	[For execution of command No.9502H] The command execution result and slice position No. in hexadecimal are stored in the high and low bytes respectively as shown below. <div style="text-align: center;"> </div>
		[For execution of command No.1502H] The command execution result and start slice No. in hexadecimal are stored in the high and low bytes respectively as shown below. <div style="text-align: center;"> </div>
Cr.1	Cr.1	The executed command No. (9502H/1502H) is stored. (Hexadecimal)

Table 8.21 Values stored in "Cr" Command result area (When completed normally) (Continued)

Cr	Command result area	Result details
Cr.2		<p>The SSI monoflop time setting is stored.</p> <div style="text-align: center;"> </div> <p>SSI monoflop time setting 0H: 48μs 1H: 64μs 2H: 80μs 3H: 96μs</p>
Cr.3		0000H is stored.

(b) When failed ("Cr.0(15-8)" Command execution result is other than 00H.)

Table 8.22 Values stored in "Cr" Command result area (When failed)

Cr	Command result area	Result details
Cr.0		<p>[For execution of command No.9502H] The command execution result and slice position No. in hexadecimal are stored in the high and low bytes respectively as shown below.</p> <div style="text-align: center;"> </div>
Cr.0		<p>[For execution of command No.1502H] The command execution result and start slice No. in hexadecimal are stored in the high and low bytes respectively as shown below.</p> <div style="text-align: center;"> </div>
Cr.1		The executed command No. (9502H/1502H) is stored. (Hexadecimal)
Cr.2	Cw.2	Argument 1 at command execution is stored.
Cr.3	Cw.3	Argument 2 at command execution is stored.

* 1 When 0FH is stored in Cr.0(15-8) Command execution result, 00H (slice position No. or start slice No. of the head module) is stored in Cr.0(7-0) Slice position No. or start slice No.

8.4.4 Latch mode setting read (Command No.: 9503H/1503H)

Data size	
<input type="checkbox"/> Cw	4 words (8 bytes)
<input type="checkbox"/> Cr	4 words (8 bytes)

This commands reads the latch mode setting from RAM of the ST1SS1.

(1) Values set to "Cw" Command execution area

Table 8.23 Values set to "Cw" Command execution area

<input type="checkbox"/> Cw Command execution area	Setting value
<input type="checkbox"/> Cw.0	[For execution of command No.9503H] Set a slice position No. of the target ST1SS1. (Hexadecimal) [For execution of command No.1503H] Set a start slice No. of the target ST1SS1. (Hexadecimal)
<input type="checkbox"/> Cw.1	Set a command No. to be executed (9503H/1503H). (Hexadecimal)
<input type="checkbox"/> Cw.2	Fixed to 0000H. (Any other value is treated as 0000H.)
<input type="checkbox"/> Cw.3	

(2) Values stored in "Cr" Command result area

The command execution result data vary depending on the result data (normal completion or failure) in Cr.0(15-8) Command execution result.

(a) When completed normally ("Cr.0(15-8)" Command execution result is 00H.)

Table 8.24 Values stored in "Cr" Command result area (When completed normally)

<input type="checkbox"/> Cr Command result area	Result details
<input type="checkbox"/> Cr.0	[For execution of command No.9503H] The command execution result and slice position No. in hexadecimal are stored in the high and low bytes respectively as shown below. <div style="text-align: center;"> <p style="text-align: center;">b15 ~ b8 b7 ~ b0</p> <p style="text-align: center;"><input type="checkbox"/> Cr.0(15-8) Command execution result <input type="checkbox"/> Cr.0(7-0) Slice position No.</p> <p style="text-align: center;">→ 00H: Normal completion</p> </div>
	[For execution of command No.1503H] The command execution result and start slice No. in hexadecimal are stored in the high and low bytes respectively as shown below. <div style="text-align: center;"> <p style="text-align: center;">b15 ~ b8 b7 ~ b0</p> <p style="text-align: center;"><input type="checkbox"/> Cr.0(15-8) Command execution result <input type="checkbox"/> Cr.0(7-0) Start slice No.</p> <p style="text-align: center;">→ 00H: Normal completion</p> </div>
<input type="checkbox"/> Cr.1	The executed command No. (9503H/1503H) is stored. (Hexadecimal)

Table 8.24 Values stored in "Cr" Command result area (When completed normally) (Continued)

Cr	Command result area	Result details
Cr.2		<p>The latch mode setting is stored.</p> <p>Fixed to 0. H</p> <p>Latch mode setting 0H: No latch 1H: Rising edge 2H: Falling edge 3H: Rising + Falling edge</p>
Cr.3		0000H is stored.

(b) When failed ("Cr.0(15-8)" Command execution result is other than 00H.)

Table 8.25 Values stored in "Cr" Command result area (When failed)

Cr	Command result area	Result details
Cr.0		<p>[For execution of command No.9503H] The command execution result and slice position No. in hexadecimal are stored in the high and low bytes respectively as shown below.</p> <p>Other than 00H: Failure (Section 8.7 Values Stored into Command Execution Result)</p>
Cr.0		<p>[For execution of command No.1503H] The command execution result and start slice No. in hexadecimal are stored in the high and low bytes respectively as shown below.</p> <p>Other than 00H: Failure (Section 8.7 Values Stored into Command Execution Result)</p>
Cr.1		The executed command No. (9503H/1503H) is stored. (Hexadecimal)
Cr.2	Cw.2	Argument 1 at command execution is stored.
Cr.3	Cw.3	Argument 2 at command execution is stored.

* 1 When 0FH is stored in Cr.0(15-8) Command execution result, 00H (slice position No. or start slice No. of the head module) is stored in Cr.0(7-0) Slice position No. or start slice No.

8.4.5 Coincidence detection flag setting read (Command No.: 9504H/1504H)

Data size	
Cw	4 words (8 bytes)
Cr	4 words (8 bytes)

This command reads the coincidence detection setting from RAM of the ST1SS1.

(1) Values set to "Cw" Command execution area

Table 8.26 Values set to "Cw" Command execution area

Cw Command execution area	Setting value
Cw.0	[For execution of command No.9504H] Set a slice position No. of the target ST1SS1. (Hexadecimal)
	[For execution of command No.1504H] Set a start slice No. of the target ST1SS1. (Hexadecimal)
Cw.1	Set a command No. to be executed (9504H/1504H). (Hexadecimal)
Cw.2	Fixed to 0000H. (Any other value is treated as 0000H.)
Cw.3	

(2) Values stored in "Cr" Command result area

The command execution result data vary depending on the result data (normal completion or failure) in Cr.0(15-8) Command execution result.

(a) When completed normally ("Cr.0(15-8)" Command execution result is 00H.)

Table 8.27 Values stored in "Cr" Command result area (When completed normally)

Cr Command result area	Result details												
Cr.0	[For execution of command No.9504H] The command execution result and slice position No. in hexadecimal are stored in the high and low bytes respectively as shown below. <div style="text-align: center;"> <table border="1" style="margin: auto;"> <tr> <td style="text-align: center;">b15</td> <td style="text-align: center;">~</td> <td style="text-align: center;">b8</td> <td style="text-align: center;">b7</td> <td style="text-align: center;">~</td> <td style="text-align: center;">b0</td> </tr> <tr> <td colspan="3" style="text-align: center;">Cr.0(15-8) Command execution result</td> <td colspan="3" style="text-align: center;">Cr.0(7-0) Slice position No.</td> </tr> </table> <p>→ 00H: Normal completion</p> </div>	b15	~	b8	b7	~	b0	Cr.0(15-8) Command execution result			Cr.0(7-0) Slice position No.		
	b15	~	b8	b7	~	b0							
Cr.0(15-8) Command execution result			Cr.0(7-0) Slice position No.										
[For execution of command No.1504H] The command execution result and start slice No. in hexadecimal are stored in the high and low bytes respectively as shown below. <div style="text-align: center;"> <table border="1" style="margin: auto;"> <tr> <td style="text-align: center;">b15</td> <td style="text-align: center;">~</td> <td style="text-align: center;">b8</td> <td style="text-align: center;">b7</td> <td style="text-align: center;">~</td> <td style="text-align: center;">b0</td> </tr> <tr> <td colspan="3" style="text-align: center;">Cr.0(15-8) Command execution result</td> <td colspan="3" style="text-align: center;">Cr.0(7-0) Start slice No.</td> </tr> </table> <p>→ 00H: Normal completion</p> </div>	b15	~	b8	b7	~	b0	Cr.0(15-8) Command execution result			Cr.0(7-0) Start slice No.			
b15	~	b8	b7	~	b0								
Cr.0(15-8) Command execution result			Cr.0(7-0) Start slice No.										
Cr.1	The executed command No. (9504H/1504H) is stored. (Hexadecimal)												

Table 8.27 Values stored in "Cr" Command result area (When completed normally) (Continued)

Cr	Command result area	Result details
		The coincidence detection setting is stored.
	Cr.2	<p>Coincidence detection flag setting 0H: No comparator 1H: Upward 2H: Downward 3H: Upward + Downward</p>
	Cr.3	0000H is stored.

(b) When failed ("Cr.0(15-8)" Command execution result is other than 00H.)

Table 8.28 Values stored in "Cr" Command result area (When failed)

Cr	Command result area	Result details
		[For execution of command No.9504H] The command execution result and slice position No. in hexadecimal are stored in the high and low bytes respectively as shown below.
	Cr.0	<p>Other than 00H: Failure (Hand icon) Section 8.7 Values Stored into Command Execution Result</p>
		[For execution of command No.1504H] The command execution result and start slice No. in hexadecimal are stored in the high and low bytes respectively as shown below.
	Cr.0	<p>Other than 00H: Failure (Hand icon) Section 8.7 Values Stored into Command Execution Result</p>
	Cr.1	The executed command No. (9504H/1504H) is stored. (Hexadecimal)
	Cr.2	Cw.2 Argument 1 at command execution is stored.
	Cr.3	Cw.3 Argument 2 at command execution is stored.

* 1 When 0FH is stored in Cr.0(15-8) Command execution result, 00H (slice position No. or start slice No. of the head module) is stored in Cr.0(7-0) Slice position No. or start slice No.

8.4.6 Coincidence detection value read (Command No.: 9505H/1505H)

Data size	
<input type="checkbox"/> Cw	4 words (8 bytes)
<input type="checkbox"/> Cr	4 words (8 bytes)

This command reads the coincidence detection value from RAM of the ST1SS1.

(1) Values set to "Cw" Command execution area

Table 8.29 Values set to "Cw" Command execution area

<input type="checkbox"/> Cw Command execution area	Setting value
<input type="checkbox"/> Cw.0	[For execution of command No.9505H] Set a slice position No. of the target ST1SS1. (Hexadecimal) [For execution of command No.1505H] Set a start slice No. of the target ST1SS1. (Hexadecimal)
<input type="checkbox"/> Cw.1	Set a command No. to be executed. (9505H/1505H) (Hexadecimal)
<input type="checkbox"/> Cw.2	Fixed to 0000H. (Any other value is treated as 0000H.)
<input type="checkbox"/> Cw.3	

(2) Values stored in "Cr" Command result area

The command execution result data vary depending on the result data (normal completion or failure) in Cr.0(15-8) Command execution result.

(a) When completed normally ("Cr.0(15-8)" Command execution result is 00H.)

Table 8.30 Values stored in "Cr" Command result area (When completed normally)

<input type="checkbox"/> Cr Command result area	Result details
<input type="checkbox"/> Cr.0	<p>[For execution of command No.9505H] The command execution result and slice position No. in hexadecimal are stored in the high and low bytes respectively as shown below.</p> <p style="text-align: center;"> b_{15} \sim b_8 b_7 \sim b_0 <input type="checkbox"/> Cr.0(15-8) Command execution result <input type="checkbox"/> Cr.0(7-0) Slice position No. } → 00H: Normal completion </p>
	<p>[For execution of command No.1505H] The command execution result and start slice No. in hexadecimal are stored in the high and low bytes respectively as shown below.</p> <p style="text-align: center;"> b_{15} \sim b_8 b_7 \sim b_0 <input type="checkbox"/> Cr.0(15-8) Command execution result <input type="checkbox"/> Cr.0(7-0) Start slice No. } → 00H: Normal completion </p>
<input type="checkbox"/> Cr.1	The executed command No. (9505H/1505H) is stored. (Hexadecimal)

Table 8.30 Values stored in "Cr" Command result area (When completed normally) (Continued)

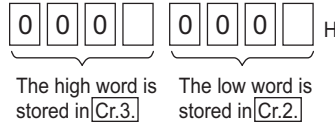
Cr	Command result area	Result details
	Cr.2	The low word (b0 to b15) of the coincidence detection value is stored in "Cr.2".
	Cr.3	The high word (b16 to b31) of the coincidence detection value is stored in "Cr.3". [Example] When the coincidence detection value is 1000000 

(b) When failed ("Cr.0(15-8)" Command execution result is other than 00H.)

Table 8.31 Values stored in "Cr" Command result area (When failed)

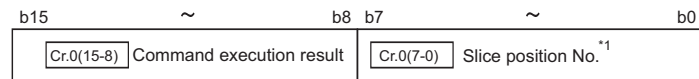
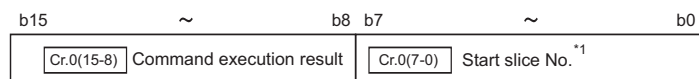
Cr	Command result area	Result details
	Cr.0	<p>[For execution of command No.9505H] The command execution result and slice position No. in hexadecimal are stored in the high and low bytes respectively as shown below.</p>  <p>Other than 00H: Failure (→ Section 8.7 Values Stored into Command Execution Result)</p>
	Cr.0	<p>[For execution of command No.1505H] The command execution result and start slice No. in hexadecimal are stored in the high and low bytes respectively as shown below.</p>  <p>Other than 00H: Failure (→ Section 8.7 Values Stored into Command Execution Result)</p>
	Cr.1	The executed command No. (9505H/1505) is stored. (Hexadecimal)
	Cr.2	Cr.w.2 Argument 1 at command execution is stored.
	Cr.3	Cr.w.3 Argument 2 at command execution is stored.

* 1 When 0FH is stored in Cr.0(15-8) Command execution result, 00H (slice position No. or start slice No. of the head module) is stored in Cr.0(7-0) Slice position No. or start slice No.

8.5 ST1SS1 Parameter Setting Write Commands

8.5.1 SSI trailing bits setting write (Command No.: A501H/2501H)

Data size	
Cw	4 words (8 bytes)
Cr	4 words (8 bytes)

This command writes the SSI trailing bits setting to RAM of the ST1SS1, and can be executed only in normal mode and when Bw.n+1 Convert setting request is OFF (0).

(1) Values set to "Cw" Command execution area

Table 8.32 Values set to "Cw" Command execution area

<input type="checkbox"/> Cw Command execution area	Setting value																														
<input type="checkbox"/> Cw.0	[For execution of command No.A501H] Set a slice position No. of the target ST1SS1. (Hexadecimal) [For execution of command No.2501H] Set a start slice No. of the target ST1SS1. (Hexadecimal)																														
<input type="checkbox"/> Cw.1	Set a command No. to be executed (A501H/2501H). (Hexadecimal)																														
<input type="checkbox"/> Cw.2	Set an SSI trailing bits setting value. <div style="text-align: center;"> <table border="0"> <tr> <td style="border: 1px solid black; padding: 2px;">0</td> <td style="border: 1px solid black; padding: 2px;">0</td> <td style="border: 1px solid black; padding: 2px;">0</td> <td style="border: 1px solid black; padding: 2px;"> </td> <td style="padding-left: 5px;">H</td> </tr> <tr> <td colspan="3" style="text-align: center;">└── Fixed to 0. ─┘</td> <td style="text-align: center;">└──</td> <td></td> </tr> <tr> <td colspan="4"></td> <td style="padding-left: 20px;">SS1 trailing bits setting</td> </tr> <tr> <td colspan="4"></td> <td style="padding-left: 20px;">0H: 0bit</td> </tr> <tr> <td colspan="4"></td> <td style="padding-left: 20px;">}</td> </tr> <tr> <td colspan="4"></td> <td style="padding-left: 20px;">1H: 15bit</td> </tr> </table> </div>	0	0	0		H	└── Fixed to 0. ─┘			└──						SS1 trailing bits setting					0H: 0bit					}					1H: 15bit
0	0	0		H																											
└── Fixed to 0. ─┘			└──																												
				SS1 trailing bits setting																											
				0H: 0bit																											
				}																											
				1H: 15bit																											
<input type="checkbox"/> Cw.3	Fixed to 0000H. (Any other value is treated as 0000H.)																														

(2) Values stored in "Cr" Command result area

The command execution result data vary depending on the result data (normal completion or failure) in Cr.0(15-8) Command execution result.

(a) When completed normally ("Cr.0(15-8)" Command execution result is 00H.)
Table 8.33 Values stored in "Cr" Command result area (When completed normally)

Cr	Command result area	Result details
Cr.0		<p>[For execution of command No.A501H] The command execution result and slice position No. in hexadecimal are stored in the high and low bytes respectively as shown below.</p>
		<p>[For execution of command No.2501H] The command execution result and start slice No. in hexadecimal are stored in the high and low bytes respectively as shown below.</p>
Cr.1		The executed command No. (A501H/2501H) is stored. (Hexadecimal)
Cr.2		0000H is stored.
Cr.3		

(b) When failed ("Cr.0(15-8)" Command execution result is other than 00H.)
Table 8.34 Values stored in "Cr" Command result area (When failed)

Cr	Command result area	Result details
Cr.0		<p>[For execution of command No.A501H] The command execution result and slice position No. in hexadecimal are stored in the high and low bytes respectively as shown below.</p>
		<p>[For execution of command No.2501H] The command execution result and start slice No. in hexadecimal are stored in the high and low bytes respectively as shown below.</p>
Cr.1		The executed command No. (A501H/2501H) is stored. (Hexadecimal)
Cr.2	Cw.2	Argument 1 at command execution is stored.
Cr.3	Cw.3	Argument 2 at command execution is stored.

* 1 When 0FH is stored in Cr.0(15-8) Command execution result, 00H (slice position No. or start slice No. of the head module) is stored in Cr.0(7-0) Slice position No. or start slice No.

8.5.2 SSI monoflop time setting write (Command No.: A502H/2502H)

Data size	
Cw	4 words (8 bytes)
Cr	4 words (8 bytes)

This command writes the SSI monoflop time setting to RAM of the ST1SS1, and can be executed only in normal mode and when Bw.n+1 Convert setting request is OFF (0).

(1) Values set to "Cw" Command execution area

Table 8.35 Values set to "Cw" Command execution area

<input type="checkbox"/> Cw Command execution area	Setting value																																			
<input type="checkbox"/> Cw.0	[For execution of command No.A502H] Set a slice position No. of the target ST1SS1. (Hexadecimal) [For execution of command No.2502H] Set a start slice No. of the target ST1SS1. (Hexadecimal)																																			
<input type="checkbox"/> Cw.1	Set a command No. to be executed (A502H/2502H). (Hexadecimal)																																			
<input type="checkbox"/> Cw.2	Set an SSI monoflop time setting value. <div style="text-align: center;"> <table border="0"> <tr> <td style="border: 1px solid black; padding: 2px;">0</td> <td style="border: 1px solid black; padding: 2px;">0</td> <td style="border: 1px solid black; padding: 2px;">0</td> <td style="border: 1px solid black; padding: 2px;"> </td> <td style="padding-left: 5px;">H</td> </tr> <tr> <td colspan="3" style="text-align: center;">└───┬───┬───┘</td> <td style="text-align: center;">└───┘</td> <td></td> </tr> <tr> <td colspan="3" style="text-align: center;">Fixed to 0.</td> <td style="text-align: center;">└───┘</td> <td style="padding-left: 10px;">SSi monoflop time setting</td> </tr> <tr> <td colspan="3"></td> <td></td> <td style="padding-left: 10px;">0H: 48μs</td> </tr> <tr> <td colspan="3"></td> <td></td> <td style="padding-left: 10px;">1H: 64μs</td> </tr> <tr> <td colspan="3"></td> <td></td> <td style="padding-left: 10px;">2H: 80μs</td> </tr> <tr> <td colspan="3"></td> <td></td> <td style="padding-left: 10px;">3H: 96μs</td> </tr> </table> </div>	0	0	0		H	└───┬───┬───┘			└───┘		Fixed to 0.			└───┘	SSi monoflop time setting					0H: 48μs					1H: 64μs					2H: 80μs					3H: 96μs
0	0	0		H																																
└───┬───┬───┘			└───┘																																	
Fixed to 0.			└───┘	SSi monoflop time setting																																
				0H: 48μs																																
				1H: 64μs																																
				2H: 80μs																																
				3H: 96μs																																
<input type="checkbox"/> Cw.3	Fixed to 0000H. (Any other value is treated as 0000H.)																																			

(2) Values stored in "Cr" Command result area

The command execution result data vary depending on the result data (normal completion or failure) in Cr.0(15-8) Command execution result.

(a) When completed normally ("Cr.0(15-8)" Command execution result is 00H.)

Table 8.36 Values stored in "Cr" Command result area (When completed normally)

Cr Command result area	Result details
Cr.0	<p>[For execution of command No.A502H] The command execution result and slice position No. in hexadecimal are stored in the high and low bytes respectively as shown below.</p> <div style="text-align: center;"> <p style="text-align: center;">b15 ~ b8 b7 ~ b0</p> <p style="text-align: center;"> Cr.0(15-8) Command execution result Cr.0(7-0) Slice position No. </p> <p style="text-align: center;">→ 00H: Normal completion</p> </div>
	<p>[For execution of command No.2502H] The command execution result and start slice No. in hexadecimal are stored in the high and low bytes respectively as shown below.</p> <div style="text-align: center;"> <p style="text-align: center;">b15 ~ b8 b7 ~ b0</p> <p style="text-align: center;"> Cr.0(15-8) Command execution result Cr.0(7-0) Start slice No. </p> <p style="text-align: center;">→ 00H: Normal completion</p> </div>
Cr.1	The executed command No. (A502H/2502H) is stored. (Hexadecimal)
Cr.2	
Cr.3	0000H is stored.

(b) When failed ("Cr.0(15-8)" Command execution result is other than 00H.)

Table 8.37 Values stored in "Cr" Command result area (When failed)

Cr Command result area	Result details
Cr.0	<p>[For execution of command No.A502H] The command execution result and slice position No. in hexadecimal are stored in the high and low bytes respectively as shown below.</p> <div style="text-align: center;"> <p style="text-align: center;"> Cr.0(15-8) Command execution result Cr.0(7-0) Slice position No. *1 </p> <p style="text-align: center;"> ↳ Other than 00H: Failure (↳ Section 8.7 Values Stored into Command Execution Result) </p> </div> <hr/> <p>[For execution of command No.2502H] The command execution result and start slice No. in hexadecimal are stored in the high and low bytes respectively as shown below.</p> <div style="text-align: center;"> <p style="text-align: center;"> Cr.0(15-8) Command execution result Cr.0(7-0) Start slice No. *1 </p> <p style="text-align: center;"> ↳ Other than 00H: Failure (↳ Section 8.7 Values Stored into Command Execution Result) </p> </div>
Cr.1	The executed command No. (A502H/2502H) is stored. (Hexadecimal)
Cr.2	Cw.2 Argument 1 at command execution is stored.
Cr.3	Cw.3 Argument 2 at command execution is stored.

* 1 When 0FH is stored in Cr.0(15-8) Command execution result, 00H (slice position No. or start slice No. of the head module) is stored in Cr.0(7-0) Slice position No. or start slice No.

8.5.3 Latch mode setting write (Command No.: A503H/2503H)

Data size	
Cw	4 words (8 bytes)
Cr	4 words (8 bytes)

This command writes the latch mode setting to RAM of the ST1SS1, and can be executed only in normal mode and when Bw.n+1 Convert setting request is OFF (0).

(1) Values set to "Cw" Command execution area

Table 8.38 Values set to "Cw" Command execution area

<input type="checkbox"/> Cw Command execution area	Setting value																																			
<input type="checkbox"/> Cw.0	[For execution of command No.A503H] Set a slice position No. of the target ST1SS1. (Hexadecimal) [For execution of command No.2503H] Set a start slice No. of the target ST1SS1. (Hexadecimal)																																			
<input type="checkbox"/> Cw.1	Set a command No. to be executed (A503H/2503H). (Hexadecimal)																																			
<input type="checkbox"/> Cw.2	Set a latch mode setting value. <div style="text-align: center;"> <table border="0"> <tr> <td style="border: 1px solid black; padding: 2px;">0</td> <td style="border: 1px solid black; padding: 2px;">0</td> <td style="border: 1px solid black; padding: 2px;">0</td> <td style="border: 1px solid black; padding: 2px;"> </td> <td style="padding: 0 5px;">H</td> </tr> <tr> <td colspan="4" style="text-align: center;">Fixed to 0.</td> <td></td> </tr> <tr> <td colspan="4"></td> <td style="text-align: center;">└─ Latch mode setting</td> </tr> <tr> <td colspan="4"></td> <td style="text-align: center;">0H: No latch</td> </tr> <tr> <td colspan="4"></td> <td style="text-align: center;">1H: Rising edge</td> </tr> <tr> <td colspan="4"></td> <td style="text-align: center;">2H: Falling edge</td> </tr> <tr> <td colspan="4"></td> <td style="text-align: center;">3H: Rising + Falling edge</td> </tr> </table> </div>	0	0	0		H	Fixed to 0.									└─ Latch mode setting					0H: No latch					1H: Rising edge					2H: Falling edge					3H: Rising + Falling edge
0	0	0		H																																
Fixed to 0.																																				
				└─ Latch mode setting																																
				0H: No latch																																
				1H: Rising edge																																
				2H: Falling edge																																
				3H: Rising + Falling edge																																
<input type="checkbox"/> Cw.3	Fixed to 0000H. (Any other value is treated as 0000H.)																																			

(2) Values stored in "Cr" Command result area

The command execution result data vary depending on the result data (normal completion or failure) in Cr.0(15-8) Command execution result.

(a) When completed normally ("Cr.0(15-8)" Command execution result is 00H.)

Table 8.39 Values stored in "Cr" Command result area (When completed normally)

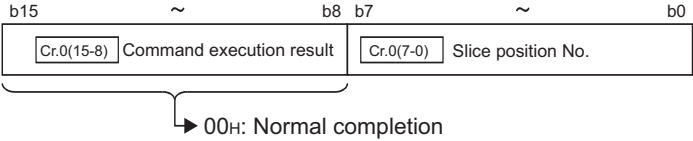
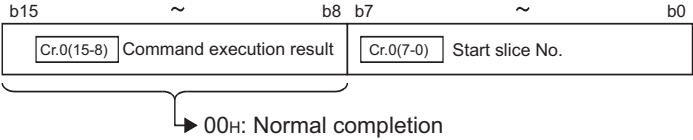
Cr Command result area	Result details
Cr.0	<p>[For execution of command No.A503H] The command execution result and slice position No. in hexadecimal are stored in the high and low bytes respectively as shown below.</p>  <p style="text-align: center;">→ 00H: Normal completion</p>
	<p>[For execution of command No.2503H] The command execution result and start slice No. in hexadecimal are stored in the high and low bytes respectively as shown below.</p>  <p style="text-align: center;">→ 00H: Normal completion</p>
Cr.1	The executed command No. (A503H/2503H) is stored. (Hexadecimal)
Cr.2	
Cr.3	0000H is stored.

(b) When failed ("Cr.0(15-8)" Command execution result is other than 00H.)

Table 8.40 Values stored in "Cr" Command result area (When failed)

Cr Command result area	Result details
Cr.0	<p>[For execution of command No.A503H] The command execution result and slice position No. in hexadecimal are stored in the high and low bytes respectively as shown below.</p> <div style="text-align: center;"> </div> <p>[For execution of command No.2503H] The command execution result and start slice No. in hexadecimal are stored in the high and low bytes respectively as shown below.</p> <div style="text-align: center;"> </div>
Cr.1	The executed command No. (A503H/2503H) is stored. (Hexadecimal)
Cr.2	Cw.2 Argument 1 at command execution is stored.
Cr.3	Cw.3 Argument 2 at command execution is stored.

* 1 When 0FH is stored in Cr.0(15-8) Command execution result, 00H (slice position No. or start slice No. of the head module) is stored in Cr.0(7-0) Slice position No. or start slice No.

8.5.4 Coincidence detection flag setting write (Command No.: A504H/2504H)

Data size	
Cw	4 words (8 bytes)
Cr	4 words (8 bytes)

This command writes the coincidence detection flag setting to RAM of the ST1SS1, and can be executed only in normal mode and when $\overline{\text{Bw.n+1}}$ Convert setting request is OFF (0).

(1) Values set to "Cw" Command execution area

Table 8.41 Values set to "Cw" Command execution area

$\overline{\text{Cw}}$ Command execution area	Setting value					
$\overline{\text{Cw.0}}$	[For execution of command No.A504H] Set a slice position No. of the target ST1SS1AD. (Hexadecimal)					
$\overline{\text{Cw.1}}$	[For execution of command No.2504H] Set a start slice No. of the target ST1SS1AD. (Hexadecimal)					
$\overline{\text{Cw.2}}$	Set a coincidence detection setting flag. <div style="text-align: center;"> <table border="1" style="display: inline-table; border-collapse: collapse;"> <tr> <td style="padding: 2px 5px;">0</td> <td style="padding: 2px 5px;">0</td> <td style="padding: 2px 5px;">0</td> <td style="padding: 2px 5px;"> </td> <td style="padding: 2px 5px;">H</td> </tr> </table> <p style="margin-left: 40px;">Fixed to 0. ↘ Coincidence detection flag setting 0H: No comparator 1H: Upward 2H: Downward 3H: Upward + Downward</p> </div>	0	0	0		H
0	0	0		H		
$\overline{\text{Cw.3}}$	Fixed to 0000H. (Any other value is treated as 0000H.)					

(2) Values stored in "Cr" Command result area

The command execution result data vary depending on the result data (normal completion or failure) in Cr.0(15-8) Command execution result.

(a) When completed normally ("Cr.0(15-8)" Command execution result is 00H.)

Table 8.42 Values stored in "Cr" Command result area (When completed normally)

Cr Command result area	Result details
Cr.0	<p>[For execution of command No.A504H] The command execution result and slice position No. in hexadecimal are stored in the high and low bytes respectively as shown below.</p> <div style="text-align: center;"> <p style="text-align: center;">b15 ~ b8 b7 ~ b0</p> <p style="text-align: center;"> Cr.0(15-8) Command execution result Cr.0(7-0) Slice position No. </p> <p style="text-align: center;">→ 00H: Normal completion</p> </div>
	<p>[For execution of command No.2504H] The command execution result and start slice No. in hexadecimal are stored in the high and low bytes respectively as shown below.</p> <div style="text-align: center;"> <p style="text-align: center;">b15 ~ b8 b7 ~ b0</p> <p style="text-align: center;"> Cr.0(15-8) Command execution result Cr.0(7-0) Start slice No. </p> <p style="text-align: center;">→ 00H: Normal completion</p> </div>
Cr.1	The executed command No. (A504H/2504H) is stored. (Hexadecimal)
Cr.2	0000H is stored.
Cr.3	

(b) When failed ("Cr.0(15-8)" Command execution result is other than 00H.)

Table 8.43 Values stored in "Cr" Command result area (When failed)

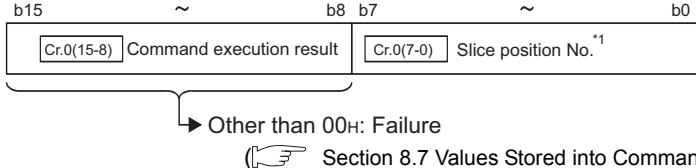
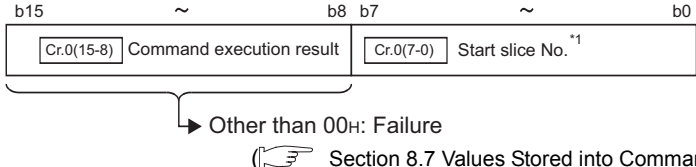
Cr Command result area	Result details
Cr.0	<p>[For execution of command No.A504H] The command execution result and slice position No. in hexadecimal are stored in the high and low bytes respectively as shown below.</p>  <p>Other than 00H: Failure (☞ Section 8.7 Values Stored into Command Execution Result)</p> <hr/> <p>[For execution of command No.2504H] The command execution result and start slice No. in hexadecimal are stored in the high and low bytes respectively as shown below.</p>  <p>Other than 00H: Failure (☞ Section 8.7 Values Stored into Command Execution Result)</p>
Cr.1	The executed command No. (A504H/2504H) is stored. (Hexadecimal)
Cr.2	Cr.2 Argument 1 at command execution is stored.
Cr.3	Cr.3 Argument 2 at command execution is stored.

* 1 When 0FH is stored in Cr.0(15-8) Command execution result, 00H (slice position No. or start slice No. of the head module) is stored in Cr.0(7-0) Slice position No. or start slice No.

8.5.5 Coincidence detection value write (Command No.: A505H/2505H)

Data size	
<input type="checkbox"/> Cw	4 words (8 bytes)
<input type="checkbox"/> Cr	4 words (8 bytes)

This command writes a coincidence detection value to RAM of the ST1SS1, and can be executed only in normal mode and when Bw.n+1 Convert setting request is OFF (0).

(1) Values set to "Cw" Command execution area

Table 8.44 Values set to "Cw" Command execution area

<input type="checkbox"/> Cw Command execution area	Setting value																		
<input type="checkbox"/> Cw.0	<p>[For execution of command No.A505H] Set a slice position No. of the target ST1SS1. (Hexadecimal)</p> <p>[For execution of command No.2505H] Set a start slice No. of the target ST1SS1. (Hexadecimal)</p>																		
<input type="checkbox"/> Cw.1	Set a command No. (A505H/2505H) to be executed. (Hexadecimal)																		
<input type="checkbox"/> Cw.2	Set the low word (b0 to b15) of a coincidence detection value in "Cw.2".																		
<input type="checkbox"/> Cw.3	<p>Set the high word (b16 to b31) of a coincidence detection value in "Cw.3".</p> <p>[Example] When the coincidence detection value is set to 10000000 (989680H).</p> <div style="text-align: center;"> <table style="border-collapse: collapse; margin: auto;"> <tr> <td style="border: 1px solid black; padding: 2px 5px;">0</td> <td style="border: 1px solid black; padding: 2px 5px;">0</td> <td style="border: 1px solid black; padding: 2px 5px;">9</td> <td style="border: 1px solid black; padding: 2px 5px;">8</td> <td style="border: 1px solid black; padding: 2px 5px;">9</td> <td style="border: 1px solid black; padding: 2px 5px;">6</td> <td style="border: 1px solid black; padding: 2px 5px;">8</td> <td style="border: 1px solid black; padding: 2px 5px;">0</td> <td style="padding: 0 5px;">H</td> </tr> <tr> <td colspan="4" style="text-align: center;"> Set the high word in <input type="checkbox"/> Cw.3. </td> <td colspan="4" style="text-align: center;"> Set the low word in <input type="checkbox"/> Cw.2. </td> <td></td> </tr> </table> </div>	0	0	9	8	9	6	8	0	H	Set the high word in <input type="checkbox"/> Cw.3.				Set the low word in <input type="checkbox"/> Cw.2.				
0	0	9	8	9	6	8	0	H											
Set the high word in <input type="checkbox"/> Cw.3.				Set the low word in <input type="checkbox"/> Cw.2.															

(2) Values stored in "Cr" Command result area

The command execution result data vary depending on the result data (normal completion or failure) in $\boxed{\text{Cr.0(15-8)}}$ Command execution result.

(a) When completed normally ("Cr.0(15-8)" Command execution result is 00H.)

Table 8.45 Values stored in "Cr" Command result area (When completed normally)

$\boxed{\text{Cr}}$ Command result area	Result details
$\boxed{\text{Cr.0}}$	<p>[For execution of command No.A505H] The command execution result and slice position No. in hexadecimal are stored in the high and low bytes respectively as shown below.</p> <div style="text-align: center;"> <p style="font-size: small;">b15 ~ b8 b7 ~ b0</p> <p style="font-size: small;">$\boxed{\text{Cr.0(15-8)}}$ Command execution result $\boxed{\text{Cr.0(7-0)}}$ Slice position No.</p> <p style="font-size: small;">→ 00H: Normal completion</p> </div>
$\boxed{\text{Cr.1}}$	<p>[For execution of command No.2505H] The command execution result and start slice No. in hexadecimal are stored in the high and low bytes respectively as shown below.</p> <div style="text-align: center;"> <p style="font-size: small;">b15 ~ b8 b7 ~ b0</p> <p style="font-size: small;">$\boxed{\text{Cr.0(15-8)}}$ Command execution result $\boxed{\text{Cr.0(7-0)}}$ Start slice No.</p> <p style="font-size: small;">→ 00H: Normal completion</p> </div>
$\boxed{\text{Cr.2}}$	The executed command No. (A505H/2505H) is stored. (Hexadecimal)
$\boxed{\text{Cr.3}}$	0000H is stored.

(b) When failed ("Cr.0(15-8)" Command execution result is other than 00H.)

Table 8.46 Values stored in "Cr" Command result area (When failed)

Cr	Command result area	Result details
Cr.0		<p>[For execution of command No.A505H] The command execution result and slice position No. in hexadecimal are stored in the high and low bytes respectively as shown below.</p> <div style="text-align: center;"> <p style="text-align: center;">Other than 00H: Failure (☞ Section 8.7 Values Stored into Command Execution Result)</p> </div>
		<p>[For execution of command No.2505H] The command execution result and start slice No. in hexadecimal are stored in the high and low bytes respectively as shown below.</p> <div style="text-align: center;"> <p style="text-align: center;">Other than 00H: Failure (☞ Section 8.7 Values Stored into Command Execution Result)</p> </div>
Cr.1		The executed command No. (A505H/2505H) is stored. (Hexadecimal)
Cr.2	Cw.2	Argument 1 at command execution is stored.
Cr.3	Cw.3	Argument 2 at command execution is stored.

* 1 When 0FH is stored in Cr.0(15-8) Command execution result, 00H (slice position No. or start slice No. of the head module) is stored in Cr.0(7-0) Slice position No. or start slice No.

8.6 ST1SS1 Control Commands

8.6.1 Parameter setting read from ROM (Command No.: B500H/3500H)

Data size	
<input type="checkbox"/> Cw	4 words (8 bytes)
<input type="checkbox"/> Cr	4 words (8 bytes)

This command reads parameters from ROM to RAM in the ST1SS1, and can be executed only in normal mode and when Bw.n+1 Convert setting request is OFF (0).

(1) Values set to "Cw" Command execution area

Table 8.47 Values set to "Cw" Command execution area

<input type="checkbox"/> Cw Command execution area	Setting value
<input type="checkbox"/> Cw.0	[For execution of command No.B500H] Set a slice position No. of the target ST1SS1. (Hexadecimal) [For execution of command No.3500H] Set a start slice No. of the target ST1SS1. (Hexadecimal)
<input type="checkbox"/> Cw.1	Set a command No. to be executed (B500H/3500H). (Hexadecimal)
<input type="checkbox"/> Cw.2	Fixed to 0000H. (Any other value is treated as 0000H.)
<input type="checkbox"/> Cw.3	

(2) Values stored in "Cr" Command result area

The command execution result data vary depending on the result data (normal completion or failure) in Cr.0(15-8) Command execution result.

(a) When completed normally ("Cr.0(15-8)" Command execution result is 00H.)

Table 8.48 Values stored in "Cr" Command result area (When completed normally)

<input type="checkbox"/> Cr Command result area	Result details
<input type="checkbox"/> Cr.0	[For execution of command No.B500H] The command execution result and slice position No. in hexadecimal are stored in the high and low bytes respectively as shown below. <div style="text-align: center;"> </div>
	[For execution of command No.3500H] The command execution result and start slice No. in hexadecimal are stored in the high and low bytes respectively as shown below. <div style="text-align: center;"> </div>

Table 8.48 Values stored in "Cr" Command result area (When completed normally) (Continued)

Cr	Command result area	Result details
	Cr.1	The executed command No. (B500H/3500H) is stored. (Hexadecimal)
	Cr.2	0000H is stored.
	Cr.3	

(b) When failed ("Cr.0(15-8)" Command execution result is other than 00H.)

Table 8.49 Values stored in "Cr" Command result area (When failed)

Cr	Command result area	Result details
	Cr.0	<p>[For execution of command No.B500H]</p> <p>The command execution result and slice position No. in hexadecimal are stored in the high and low bytes respectively as shown below.</p> <div style="text-align: center;"> <p style="text-align: center;">b15 ~ b8 b7 ~ b0</p> <p style="text-align: center;"> Cr.0(15-8) Command execution result Cr.0(7-0) Slice position No. *1 </p> <p style="text-align: center;"> ↳ Other than 00H: Failure (☞ Section 8.7 Values Stored into Command Execution Result) </p> </div> <p>[For execution of command No.3500H]</p> <p>The command execution result and start slice No. in hexadecimal are stored in the high and low bytes respectively as shown below.</p> <div style="text-align: center;"> <p style="text-align: center;">b15 ~ b8 b7 ~ b0</p> <p style="text-align: center;"> Cr.0(15-8) Command execution result Cr.0(7-0) Start slice No. *1 </p> <p style="text-align: center;"> ↳ Other than 00H: Failure (☞ Section 8.7 Values Stored into Command Execution Result) </p> </div>
	Cr.1	The executed command No. (B500H/3500H) is stored. (Hexadecimal)
	Cr.2	Cw.2 Argument 1 at command execution is stored.
	Cr.3	Cw.3 Argument 2 at command execution is stored.

* 1 When 0FH is stored in Cr.0(15-8) Command execution result, 00H (slice position No. or start slice No. of the head module) is stored in Cr.0(7-0) Slice position No. or start slice No.

8.6.2 Parameter setting write to ROM (Command No.: B501H/3501H)

Data size	
Cw	4 words (8 bytes)
Cr	4 words (8 bytes)

This command writes parameters from RAM to ROM in the ST1SS1, and can be executed only in normal mode and when Bw.n+1 Convert setting request is OFF (0).

(1) Values set to "Cw" Command execution area

Table 8.50 Values set to "Cw" Command execution area

Cw Command execution area	Setting value
Cw.0	[For execution of command No.B501H] Set a slice position No. of the target ST1SS1. (Hexadecimal) [For execution of command No.3501H] Set a start slice No. of the target ST1SS1. (Hexadecimal)
Cw.1	Set a command No. to be executed (B501H/3501H). (Hexadecimal)
Cw.2	Fixed to 0000H. (Any other value is treated as 0000H.)
Cw.3	

(2) Values stored in "Cr" Command result area

The command execution result data vary depending on the result data (normal completion or failure) in Cr.0(15-8) Command execution result.

(a) When completed normally ("Cr.0(15-8)" Command execution result is 00H.)

Table 8.51 Values stored in "Cr" Command result area (When completed normally)

Cr Command result area	Result details
Cr.0	[For execution of command No.B501H] The command execution result and slice position No. in hexadecimal are stored in the high and low bytes respectively as shown below. <div style="text-align: center;"> </div>
	[For execution of command No.3501H] The command execution result and start slice No. in hexadecimal are stored in the high and low bytes respectively as shown below. <div style="text-align: center;"> </div>
Cr.1	The executed command No. (B501H/3501H) is stored. (Hexadecimal)

Table 8.51 Values stored in "Cr" Command result area (When completed normally) (Continued)

Cr	Command result area	Result details
	Cr.2	0000H is stored.
	Cr.3	

(b) When failed ("Cr.0(15-8)" Command execution result is other than 00H.)

Table 8.52 Values stored in "Cr" Command result area (When failed)

Cr	Command result area	Result details																								
	Cr.0	<p>[For execution of command No.B501H] The command execution result and slice position No. in hexadecimal are stored in the high and low bytes respectively as shown below.</p> <div style="text-align: center;"> <table border="1" style="margin: auto;"> <tr> <td style="text-align: center;">b15</td> <td style="text-align: center;">~</td> <td style="text-align: center;">b8</td> <td style="text-align: center;">b7</td> <td style="text-align: center;">~</td> <td style="text-align: center;">b0</td> </tr> <tr> <td colspan="3" style="text-align: center;">Cr.0(15-8) Command execution result</td> <td colspan="3" style="text-align: center;">Cr.0(7-0) Slice position No. *1</td> </tr> </table> <p>Other than 00H: Failure (☞ Section 8.7 Values Stored into Command Execution Result)</p> </div> <p>[For execution of command No.3501H] The command execution result and start slice No. in hexadecimal are stored in the high and low bytes respectively as shown below.</p> <div style="text-align: center;"> <table border="1" style="margin: auto;"> <tr> <td style="text-align: center;">b15</td> <td style="text-align: center;">~</td> <td style="text-align: center;">b8</td> <td style="text-align: center;">b7</td> <td style="text-align: center;">~</td> <td style="text-align: center;">b0</td> </tr> <tr> <td colspan="3" style="text-align: center;">Cr.0(15-8) Command execution result</td> <td colspan="3" style="text-align: center;">Cr.0(7-0) Start slice No. *1</td> </tr> </table> <p>Other than 00H: Failure (☞ Section 8.7 Values Stored into Command Execution Result)</p> </div>	b15	~	b8	b7	~	b0	Cr.0(15-8) Command execution result			Cr.0(7-0) Slice position No. *1			b15	~	b8	b7	~	b0	Cr.0(15-8) Command execution result			Cr.0(7-0) Start slice No. *1		
b15	~	b8	b7	~	b0																					
Cr.0(15-8) Command execution result			Cr.0(7-0) Slice position No. *1																							
b15	~	b8	b7	~	b0																					
Cr.0(15-8) Command execution result			Cr.0(7-0) Start slice No. *1																							
	Cr.1	The executed command No. (B501H/3501H) is stored. (Hexadecimal)																								
	Cr.2	Cw.2 Argument 1 at command execution is stored.																								
	Cr.3	Cw.3 Argument 2 at command execution is stored.																								

* 1 When 0FH is stored in Cr.0(15-8) Command execution result, 00H (slice position No. or start slice No. of the head module) is stored in Cr.0(7-0) Slice position No. or start slice No.

☒ POINT

Check that the module normally operates with the set values written to RAM, before executing Parameter setting write to ROM (command No.: B501H/3501H).

8.7 Values Stored into Command Execution Result

The following table indicates the values stored into $\boxed{\text{Cr.n(15-8)}}$ Command execution result in $\boxed{\text{Cr}}$ Command result area.

Table 8.53 Command execution results and actions

Command execution result	Description	Action
00H	Normal completion	-
01H	The requested command is not available for the specified module.	Check Table 8.1 to see if the requested command No. is applicable for the ST1SS1 or not. Check if the specified $\boxed{\text{Cw.0}}$ Slice position No. or start slice No. matches $\boxed{\text{Cw.0}}$ Slice position No. or start slice No. of the ST1SS1.
02H	The value is out of range.	Check if the values set in $\boxed{\text{Cw.2}}$ and subsequent area in the command execution area are within the range available for the requested command No.
03H	The specified target start slice position No. or start slice No. is incorrect.	Check if the ST1SS1 is mounted in the position of the specified $\boxed{\text{Cw.0}}$ slice position No. or start slice No. Check if the specified $\boxed{\text{Cw.0}}$ slice position No. or start slice No. matches start slice No. of the ST1SS1.
04H	There is no response from the specified module.	Check Table 8.1 to see if the requested command No. is applicable for the ST1SS1 or not. If the requested command No. is applicable, the ST1SS1 may be faulty. Please consult your local Mitsubishi representative, explaining a detailed description of the problem.
05H	No communication is available with the specified module.	The ST1SS1 may be faulty. Please consult your local Mitsubishi representative, explaining a detailed description of the problem.
06H	The requested command is not executable in the current operation mode of the module.	Check the error code and take corrective actions. (☞ Section 9.1 Error Code List) If no error code is stored, check Table 8.1 to see if the requested command No. is applicable in the operation mode.
07H	The module has already been in the specified mode.	Continue the processing since the ST1SS1 specified by $\boxed{\text{Cw.0}}$ slice position No. or start slice No. is already in the requested mode.
08H	The mode of the module cannot be changed to the specified mode.	Set $\boxed{\text{Bw.n+1}}$ Convert setting request to OFF (0), and then execute the command.
09H	The specified module is in the online module change status.	Execute the command after completion of the online module change.
0AH	The specified module No. is different, or does not exist.	Check if the command parameter setting of the intelligent function module is appropriate to the specified module No.
0FH	The value of $\boxed{\text{Cw.0}}$ slice position No. or start slice No. is out of range.	Check if the value set for $\boxed{\text{Cw.0}}$ slice position No. or start slice No. is within the range or not.

Table 8.53 Command execution results and actions (Continued)

Command execution result	Description	Action
10H	Data cannot be read from the specified module.	Execute the command again.
11H	Data cannot be written to the specified module.	If the problem on the left occurs again, the ST1SS1 may be faulty. Please consult your local Mitsubishi representative, explaining a detailed description of the problem.
13H	The specified module is not in the status available for command parameter writing.	Set <input type="text" value="Bw.n+1"/> Convert setting request to OFF (0), and then execute the command.

CHAPTER9 TROUBLESHOOTING

This chapter explains the errors that may occur during operation of the ST1SS1, and how to troubleshoot them.

9.1 Error Code List

When an error occurs due to data writing to the master module, the ST1SS1 can execute the Error code read request command (command no.: 8101H/0101H) and thereby an error code is stored into Cr Command result area of the head module.

Table 9.1 Error code list

Error code (Hexadecimal)	Error level	Error name	Description	Corrective action
1100H	System error	ROM error	ROM is faulty.	Power off the ST1SS1 and then on, or reset the head module. If this error code is stored again, the ST1SS1 may be faulty. Please consult your local Mitsubishi representative, explaining a detailed description of the problem.
1200H	System error	Number of writes to ROM exceeded	Parameter setting write to ROM (command no.: B501H/3501H) was executed more than 25 times after power-on.	Commands or writes to ROM by GX Configurator-ST must not be executed more than 25 times per module after power-ON.
			Data were written to ROM by GX Configurator-ST more than 25 times.	
2001H	System error	SSI trailing bits error	The number of SSI trailing bits is greater than the SSI code length.	Set a value so that the SSI code length is greater than or equal to the number of trailing bits.
2101H	System error	SSI code length error	Any other than 2 to 31 bits is set for the SSI code length.	Set a value that is within the valid range.
2201H	System error	SSI parity error	The SSI parity setting is out of range.	Set a value that is within the valid range.
2301H	System error	SSI baud rate error	The SSI baud rate setting is out of range.	Set a value that is within the valid range.
2401H	System error	SSI monoflop time error	The SSI monoflop time setting is out of range.	Set a value that is within the valid range.
3001H	System error	Coincidence detection value error	The coincidence detection value is out of range.	Set a value that is within the valid range.
5001H	System error	DATA signal line reversal error	The DATA signal line is connected reversely.	Reverse the connection between DATA and $\overline{\text{DATA}}$.

Table 9.1 Error code list (continued)

Error code (Hexadecimal)	Error level	Error name	Description	Corrective action
5101H	System error	Start error	The data signal line is not high before SSI transmission.	<p>Check cabling, shielding, SSI baud rate, cable length and SSI code length.</p> <p>If the error persists after the check, hardware failure of the SSI absolute encoder or the ST1SS1, or the influence of noise is a probable cause.</p> <p>Replace the SSI absolute encoder, or consult your local Mitsubishi representative, explaining a detailed description of the problem.</p>
5201H	System error	End error	The data signal line is not low after SSI transmission.	<p>Check cabling, shielding, SSI baud rate, cable length and SSI code length.</p> <p>If the error persists after the check, hardware failure of the SSI absolute encoder or the ST1SS1, or the influence of noise is a probable cause.</p> <p>Replace the SSI absolute encoder, or consult your local Mitsubishi representative, explaining a detailed description of the problem.</p>
5301H	System error	Parity error	The parity bit is different between the ST1SS1 and the SSI absolute encoder.	<p>Check the cable wiring and shielding.</p> <p>Set an SSI parity setting value suitable for the SSI absolute encoder to be used.</p>
B10□H to FFFF	-	(Error detected by the head module)	-	<p>Refer to the following and take corrective actions.</p> <p> MELSEC-ST CC-Link Head Module User's Manual, "9.7.2 Error code list"</p>

POINT

- (1) Clear an error by either of the following.
 - Error clear request (command No.: 8104H/0104H)
 - Error reset request (RYnA)

For details of the above, refer to the following.

 MELSEC-ST CC-Link Head Module User's Manual, "8.2.5 Error clear request (Command No.: 8104H/0104H)"

 MELSEC-ST CC-Link Head Module User's Manual, "3.4 Remote I/O, Remote Registers"

- (2) When multiple errors in the same level occurred, a code of the error first detected by the ST1SS1 is stored.

9.2 Troubleshooting

9.2.1 When the RUN LED is flashing or turned off

(1) When flashing at 0.25s intervals

Table 9.2 When flashing at 0.25s intervals

Check item	Corrective action
Is the module selected as the target of online module change?	Refer to the following.  CHAPTER 7 ONLINE MODULE CHANGE

(2) When flashing at 1s intervals

Table 9.3 When flashing at 1s intervals

Check item	Corrective action
Has data communication been stopped between the master station and head module?	Refer to the following.  MELSEC-ST System User's Manual
Has a parameter communication error occurred between the master station and head module?	
Has an error occurred in another slice module?	
Has an internal bus error occurred?	

(3) When off

Table 9.4 When off

Check item	Corrective action
Is a module change enabled during an online module change?	Refer to the following.  CHAPTER 7 ONLINE MODULE CHANGE
Is External SYS. power being supplied?	Check whether the supply voltage of the bus refreshing module is within the rated range.
Is the capacity of the bus refreshing module adequate?	Calculate the current consumption of the mounted modules, and check that the power supply capacity is sufficient.
Is the ST1SS1 correctly mounted on the base module?	Check the mounting condition of the ST1RSS1.
Has a watchdog timer error occurred?	Power the ST1SS1 off and then on, or reset the head module, and check whether the LED turns on. If the LED still does not turn on, the possible cause is a ST1SS1 failure. Please consult your local Mitsubishi representative, explaining a detailed description of the problem.

9.2.2 When the RUN LED and the ERR. LED turned on

Table 9.5 When the RUN LED and the ERR. LED turned on

Check item	Corrective action
Has any error occurred?	Confirm the error code and take corrective action described in the error code list.  Section 9.1 Error Code List

9.2.3 When counting is not performed

Table 9.6 When counting is not performed

Check item	Corrective action
Is external AUX. power being supplied	Check whether a 24V DC voltage is supplied to the power distribution module.
Is the external wiring normally connected?	Check the external wiring.  Section 4.4 Wiring
Is the digital input for latch OFF?	Turn OFF the digital input for latch.

9.2.4 When encoder values are not correct

Table 9.7 When encoder values are not correct

Check item	Corrective action
Is the SSI code setting correct?	Select Gray code or Binary code in accordance with the SSI absolute encoder to be connected.
Is the cable length the maximum cable length or less?	Check the cable length or cable thickness.  Section 4.4.3 Cable connected between the ST1SS1 and absolute encoder Or, reduce the SSI baud rate.
Is the SSI code length setting correct?	Set an SSI code length in accordance with the resolution of the SSI absolute encoder.
Are shielded twisted pair cables used?	Use shielded twisted pair cables.
Does any noise affect the system?	Take preventive actions such as attaching a surge suppressor to magnet switches.
Is a sufficient distance is ensured between heavy electric equipment and signal lines?	Connect signal lines independently, and keep a distance of at least 100mm from the power cables.

POINT

If a normal encoder value cannot be read after performing the above actions, the possible cause is failure of the module.

Please consult your local Mitsubishi representative, explaining a detailed description of the problem.

APPENDIXES

Appendix 1 Accessories

This section explains the accessories related to the ST1SS1.

(1) Wiring marker

For how to use the wiring marker, refer to the following.

 MELSEC-ST System User's Manual, "10.2 Mounting the Modules"

Table App.1 Wiring marker list



Model name	Description	Color
ST1A-WMK-BK	Terminal marker (Signal wire)	Black
ST1A-WMK-RD	Terminal marker (24V DC)	Red

(2) Coding element



The coding element is fitted before shipment.

It is also available as an option in case it is lost.

Table App.2 Coding element list

Model name	Description	Shape ^{*1}		Color
		Base module side	Slice module side	
ST1A-CKY-18	Coding element for ST1SS1			Dark green

* 1 Indicates the position of the projection or hole when the coding element is viewed from above.

 : Protection  : Hole

Appendix 2 External Dimensions

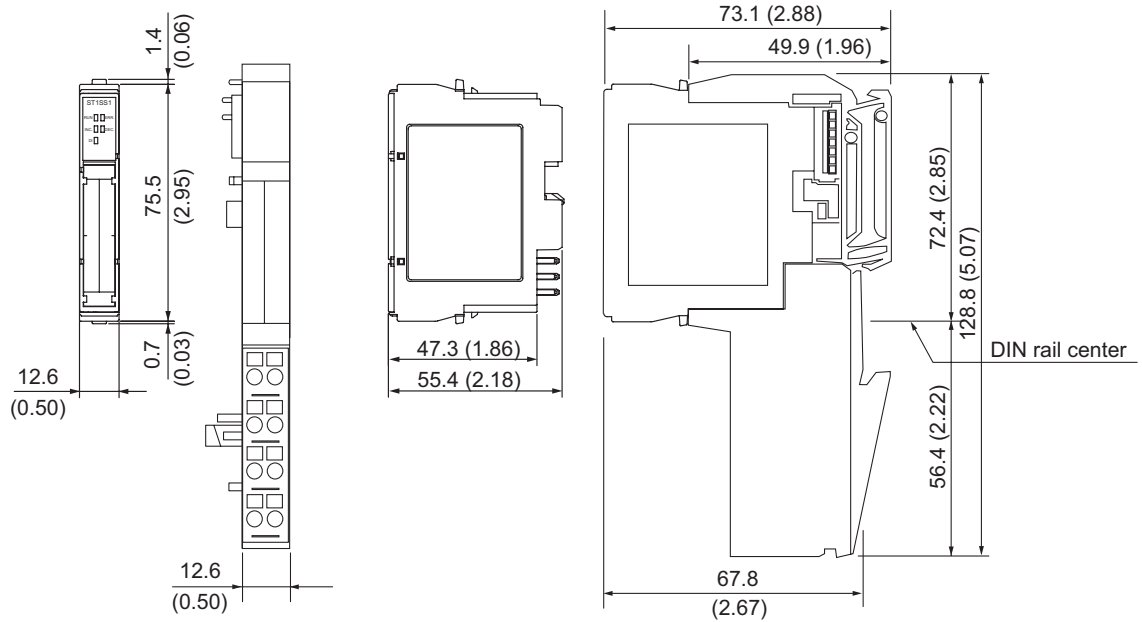

Unit: mm (inch)

Figure App.1 External dimensions

INDEX

[A]

Accessories App-1

[B]

Base module 2-2
Bit input area 3-14
Bit output area 3-16
Bw 3-16

[C]

Coding element 2-2,4-4,App-1
Coincidence detection flag 3-15
Coincidence detection flag setting read 8-21
Coincidence detection flag setting write 8-33
Coincidence detection function 3-7,3-12
Coincidence detection value read 8-23
Coincidence detection value write 8-36
Command 3-8
Command list 8-1
Command parameters 3-19
Common command 8-2
Comparator clear request 3-12
Convert setting completed flag 3-14
Convert setting request 3-16
Counter function 3-5,3-9
Counting range 3-1
Creating a project 5-2

[D]

DATA signal line error detection function 3-7
Data symbol A-11
Detection of input line error 3-1
Detection of rotational direction 3-6

[E]

EMC A-10
Encoder resolution setting function 3-5
Encoder value 3-15
Error clear request 6-25
Error code list 9-1
Error code read request 8-5
External AUX. power supply 3-1
External dimensions App-2
External input 3-1
External wiring 4-7

[F]

Forced output test 5-8
Function list 3-5

[G]

Gray code/Binary code selection 3-5
GX configurator-ST functions 5-1

[H]

Handling precautions 4-1
head module 2-2

[I]

Initial data batch write request 8-7
Initial data individual write request 8-10
Initial data setting read 8-13
Input/Output monitor 5-6
Intelligent function module processing time 3-4
Isolation 3-1
I/O Data 3-14

[L]

Latch counter function 3-6,3-11
Latch detection clear request 3-16
Latch detection flag 3-15
Latch mode setting read 8-19
Latch mode setting write 8-30
LED indications 4-5
Low voltage directives A-10

[M]

maximum cable length 4-10
Memory 3-18
Module ready 3-14

[N]

Number of occupied I/O points 3-1
Number of occupied slices 3-1

[O]

Online module change 3-8,7-1
Operating status read request 8-3

[P]

Parameter setting 5-3
Parameter setting read from ROM 8-39
Parameter setting write to ROM 8-41
Parameters 3-19
Part names 4-3
Performance specifications 3-1
Programming 6-1

[R]

RAM 3-18
Resolution 3-1
ROM 3-18
ROM write count 3-1

[S]

Setup and procedure before operation 4-2

Software package	2-2
SSI baud rate selection function	3-5
SSI code length setting function	3-5
SSI code setting function	3-5
SSI direction reversal setting	3-7
SSI monoflop time setting function	3-6,3-10
SSI monoflop time setting read	8-17
SSI monoflop time setting write	8-27
SSI parity setting function	3-6
SSI trailing bits setting function	3-7
SSI trailing bits setting read	8-15
SSI trailing bits setting write	8-25
ST1SS1 control commands	8-39
ST1SS1 parameter setting read commands	8-13
ST1SS1 parameter setting write commands	8-25
System configuration	2-1

[T]

Terminal block	4-3
Transmission path	3-1
Troubleshooting	9-3

[V]

Values stored into command execution result	8-43
---	------

[W]

Weight	3-1
Wiring	4-6
Wiring maker	App-1
Wiring precautions	4-6
Word input area	3-15

Warranty

Please confirm the following product warranty details before using this product.

1. Gratis Warranty Term and Gratis Warranty Range

If any faults or defects (hereinafter "Failure") found to be the responsibility of Mitsubishi occurs during use of the product within the gratis warranty term, the product shall be repaired at no cost via the sales representative or Mitsubishi Service Company.

However, if repairs are required onsite at domestic or overseas location, expenses to send an engineer will be solely at the customer's discretion. Mitsubishi shall not be held responsible for any re-commissioning, maintenance, or testing on-site that involves replacement of the failed module.

[Gratis Warranty Term]

The gratis warranty term of the product shall be for one year after the date of purchase or delivery to a designated place.

Note that after manufacture and shipment from Mitsubishi, the maximum distribution period shall be six (6) months, and the longest gratis warranty term after manufacturing shall be eighteen (18) months. The gratis warranty term of repair parts shall not exceed the gratis warranty term before repairs.

[Gratis Warranty Range]

- (1) The range shall be limited to normal use within the usage state, usage methods and usage environment, etc., which follow the conditions and precautions, etc., given in the instruction manual, user's manual and caution labels on the product.
- (2) Even within the gratis warranty term, repairs shall be charged for in the following cases.
 1. Failure occurring from inappropriate storage or handling, carelessness or negligence by the user. Failure caused by the user's hardware or software design.
 2. Failure caused by unapproved modifications, etc., to the product by the user.
 3. When the Mitsubishi product is assembled into a user's device, Failure that could have been avoided if functions or structures, judged as necessary in the legal safety measures the user's device is subject to or as necessary by industry standards, had been provided.
 4. Failure that could have been avoided if consumable parts (battery, backlight, fuse, etc.) designated in the instruction manual had been correctly serviced or replaced.
 5. Failure caused by external irresistible forces such as fires or abnormal voltages, and Failure caused by force majeure such as earthquakes, lightning, wind and water damage.
 6. Failure caused by reasons unpredictable by scientific technology standards at time of shipment from Mitsubishi.
 7. Any other failure found not to be the responsibility of Mitsubishi or that admitted not to be so by the user.

2. Onerous repair term after discontinuation of production

- (1) Mitsubishi shall accept onerous product repairs for seven (7) years after production of the product is discontinued.

Discontinuation of production shall be notified with Mitsubishi Technical Bulletins, etc.
- (2) Product supply (including repair parts) is not available after production is discontinued.

3. Overseas service

Overseas, repairs shall be accepted by Mitsubishi's local overseas FA Center. Note that the repair conditions at each FA Center may differ.

4. Exclusion of loss in opportunity and secondary loss from warranty liability

Regardless of the gratis warranty term, Mitsubishi shall not be liable for compensation of damages caused by any cause found not to be the responsibility of Mitsubishi, loss in opportunity, lost profits incurred to the user by Failures of Mitsubishi products, special damages and secondary damages whether foreseeable or not, compensation for accidents, and compensation for damages to products other than Mitsubishi products, replacement by the user, maintenance of on-site equipment, start-up test run and other tasks.

5. Changes in product specifications

The specifications given in the catalogs, manuals or technical documents are subject to change without prior notice.

6. Product application

- (1) In using the Mitsubishi MELSEC programmable controller, the usage conditions shall be that the application will not lead to a major accident even if any problem or fault should occur in the programmable controller device, and that backup and fail-safe functions are systematically provided outside of the device for any problem or fault.
- (2) The Mitsubishi programmable controller has been designed and manufactured for applications in general industries, etc. Thus, applications in which the public could be affected such as in nuclear power plants and other power plants operated by respective power companies, and applications in which a special quality assurance system is required, such as for Railway companies or Public service purposes shall be excluded from the programmable controller applications.

In addition, applications in which human life or property that could be greatly affected, such as in aircraft, medical applications, incineration and fuel devices, manned transportation, equipment for recreation and amusement, and safety devices, shall also be excluded from the programmable controller range of applications.

However, in certain cases, some applications may be possible, providing the user consults their local Mitsubishi representative outlining the special requirements of the project, and providing that all parties concerned agree to the special circumstances, solely at the users discretion.

Company names and product names used in this document are trademarks or registered trademarks of respective companies.

MELSEC-ST

SSI Absolute Encoder Input Module

User's Manual (CC-Link)

MODEL	ST1SS-BT-U-SY-E
MODEL CODE	13JZ16
SH(NA)-080759ENG-A(0809)KWIX	



HEAD OFFICE : TOKYO BUILDING, 2-7-3 MARUNOUCHI, CHIYODA-KU, TOKYO 100-8310, JAPAN
NAGOYA WORKS : 1-14, YADA-MINAMI 5-CHOME, HIGASHI-KU, NAGOYA, JAPAN

When exported from Japan, this manual does not require application to the Ministry of Economy, Trade and Industry for service transaction permission.

Specifications subject to change without notice.

HEADQUARTERS

MITSUBISHI ELECTRIC EUROPE B.V. **EUROPE**
 German Branch
 Gothaer Straße 8
D-40880 Ratingen
 Phone: +49 (0)2102 / 486-0
 Fax: +49 (0)2102 / 486-1120

MITSUBISHI ELECTRIC EUROPE B.V. **CZECH REPUBLIC**
 Czech Branch
 Avenir Business Park, Radlická 714/113a
CZ-158 00 Praha 5
 Phone: +420 (0)251 551 470
 Fax: +420 (0)251-551-471

MITSUBISHI ELECTRIC EUROPE B.V. **FRANCE**
 French Branch
 25, Boulevard des Bouvets
F-92741 Nanterre Cedex
 Phone: +33 (0)1 / 55 68 55 68
 Fax: +33 (0)1 / 55 68 57 57

MITSUBISHI ELECTRIC EUROPE B.V. **IRELAND**
 Irish Branch
 Westgate Business Park, Ballymount
IRL-Dublin 24
 Phone: +353 (0)1 4198800
 Fax: +353 (0)1 4198890

MITSUBISHI ELECTRIC EUROPE B.V. **ITALY**
 Italian Branch
 Viale Colleoni 7
I-20041 Agrate Brianza (MI)
 Phone: +39 039 / 60 53 1
 Fax: +39 039 / 60 53 312

MITSUBISHI ELECTRIC EUROPE B.V. **SPAIN**
 Spanish Branch
 Carretera de Rubí 76-80
E-08190 Sant Cugat del Vallés (Barcelona)
 Phone: 902 131121 // +34 935653131
 Fax: +34 935891579

MITSUBISHI ELECTRIC EUROPE B.V. **UK**
 UK Branch
 Travellers Lane
UK-Hatfield, Herts. AL10 8XB
 Phone: +44 (0)1707 / 27 61 00
 Fax: +44 (0)1707 / 27 86 95

MITSUBISHI ELECTRIC CORPORATION **JAPAN**
 Office Tower "Z" 14 F
 8-12,1 chome, Harumi Chuo-Ku
Tokyo 104-6212
 Phone: +81 3 622 160 60
 Fax: +81 3 622 160 75

MITSUBISHI ELECTRIC AUTOMATION, Inc. **USA**
 500 Corporate Woods Parkway
Vernon Hills, IL 60061
 Phone: +1 847 478 21 00
 Fax: +1 847 478 22 53

EUROPEAN REPRESENTATIVES

GEVA **AUSTRIA**
 Wiener Straße 89
AT-2500 Baden
 Phone: +43 (0)2252 / 85 55 20
 Fax: +43 (0)2252 / 488 60

TEHNIKON **BELARUS**
 Oktyabrskaya 16/5, Off. 703-711
BY-220030 Minsk
 Phone: +375 (0)17 / 210 46 26
 Fax: +375 (0)17 / 210 46 26

Koning & Hartman b.v. **BELGIUM**
 Woluwelaan 31
BE-1800 Vilvoorde
 Phone: +32 (0)2 / 257 02 40
 Fax: +32 (0)2 / 257 02 49

INEA BH d.o.o. **BOSNIA AND HERZEGOVINA**
 Aleja Lipa 56
BA-71000 Sarajevo
 Phone: +387 (0)33 / 921 164
 Fax: +387 (0)33 / 524 539

AKHNATON **BULGARIA**
 4 Andrej Ljapchev Blvd. Pb 21
BG-1756 Sofia
 Phone: +359 (0)2 / 817 6004
 Fax: +359 (0)2 / 97 44 06 1

INEA CR d.o.o. **CROATIA**
 Losinjska 4 a
HR-10000 Zagreb
 Phone: +385 (0)1 / 36 940 -01 / -02 / -03
 Fax: +385 (0)1 / 36 940 -03

AutoCont C.S. s.r.o. **CZECH REPUBLIC**
 Technická 374/6
CZ-708 00 Ostrava-Pustkovec
 Phone: +420 595 691 150
 Fax: +420 595 691 199

B:TECH A.S. **CZECH REPUBLIC**
 U Borové 69
CZ-58001 Havlíčkův Brod
 Phone: +420 (0)569 777 777
 Fax: +420 (0)569-777 778

Beijer Electronics A/S **DENMARK**
 Lykkegårdsvvej 17, 1.
DK-4000 Roskilde
 Phone: +45 (0)46 / 75 76 66
 Fax: +45 (0)46 / 75 56 26

Beijer Electronics Eesti OÜ **ESTONIA**
 Pärnu mnt.160i
EE-11317 Tallinn
 Phone: +372 (0)6 / 51 81 40
 Fax: +372 (0)6 / 51 81 49

Beijer Electronics OY **FINLAND**
 Jaakonkatu 2
FIN-01620 Vantaa
 Phone: +358 (0)207 / 463 500
 Fax: +358 (0)207 / 463 501

UTEKO A.B.E.E. **GREECE**
 5, Mavrogenous Str.
GR-18542 Piraeus
 Phone: +30 211 / 1206 900
 Fax: +30 211 / 1206 999

MELTRADE Ltd. **HUNGARY**
 Fertő utca 14.
HU-1107 Budapest
 Phone: +36 (0)1 / 431-9726
 Fax: +36 (0)1 / 431-9727

Beijer Electronics SIA **LATVIA**
 Vestienas iela 2
LV-1035 Riga
 Phone: +371 (0)784 / 2280
 Fax: +371 (0)784 / 2281

Beijer Electronics UAB **LITHUANIA**
 Savanoriu Pr. 187
LT-02300 Vilnius
 Phone: +370 (0)5 / 232 3101
 Fax: +370 (0)5 / 232 2980

EUROPEAN REPRESENTATIVES

ALFATRADE Ltd. **MALTA**
 99, Paola Hill
Malta- Paola PLA 1702
 Phone: +356 (0)21 / 697 816
 Fax: +356 (0)21 / 697 817

INTEHSIS srl **MOLDOVA**
 bld. Traian 23/1
MD-2060 Kishinev
 Phone: +373 (0)22 / 66 4242
 Fax: +373 (0)22 / 66 4280

Koning & Hartman b.v. **NETHERLANDS**
 Haarlerbergweg 21-23
NL-1101 CH Amsterdam
 Phone: +31 (0)20 / 587 76 00
 Fax: +31 (0)20 / 587 76 05

Beijer Electronics AS **NORWAY**
 Postboks 487
NO-3002 Drammen
 Phone: +47 (0)32 / 24 30 00
 Fax: +47 (0)32 / 84 85 77

MPL Technology Sp. z o.o. **POLAND**
 Ul. Krakowska 50
PL-32-083 Balice
 Phone: +48 (0)12 / 630 47 00
 Fax: +48 (0)12 / 630 47 01

Sirius Trading & Services srl **ROMANIA**
 Aleea Lacul Morii Nr. 3
RO-060841 Bucuresti, Sector 6
 Phone: +40 (0)21 / 430 40 06
 Fax: +40 (0)21 / 430 40 02

Craft Con. & Engineering d.o.o. **SERBIA**
 Bulevar Svetog Cara Konstantina 80-86
SER-18106 Nis
 Phone: +381 (0)18 / 292-24-4/5
 Fax: +381 (0)18 / 292-24-4/5

INEA SR d.o.o. **SERBIA**
 Izletnicka 10
SER-113000 Smederevo
 Phone: +381 (0)26 / 617 163
 Fax: +381 (0)26 / 617 163

AutoCont Control s.r.o. **SLOVAKIA**
 Radlinského 47
SK-02601 Dolny Kubin
 Phone: +421 (0)43 / 5868210
 Fax: +421 (0)43 / 5868210

CS MTrade Slovensko, s.r.o. **SLOVAKIA**
 Vajanskeho 58
SK-92101 Piestany
 Phone: +421 (0)33 / 7742 760
 Fax: +421 (0)33 / 7735 144

INEA d.o.o. **SLOVENIA**
 Stegne 11
SI-1000 Ljubljana
 Phone: +386 (0)1 / 513 8100
 Fax: +386 (0)1 / 513 8170

Beijer Electronics AB **SWEDEN**
 Box 426
SE-20124 Malmö
 Phone: +46 (0)40 / 35 86 00
 Fax: +46 (0)40 / 35 86 02

Econotec AG **SWITZERLAND**
 Hinterdorfstr. 12
CH-8309 Nürensdorf
 Phone: +41 (0)44 / 838 48 11
 Fax: +41 (0)44 / 838 48 12

GTS **TURKEY**
 Darülaceze Cad. No. 43 KAT. 2
TR-34384 Okmeydanı-Istanbul
 Phone: +90 (0)212 / 320 1640
 Fax: +90 (0)212 / 320 1649

CSC Automation Ltd. **UKRAINE**
 4-B, M. Raskovoyi St.
UA-02660 Kiev
 Phone: +380 (0)44 / 494 33 55
 Fax: +380 (0)44 / 494-33-66

EURASIAN REPRESENTATIVES

Kazpromautomatiks Ltd. **KAZAKHSTAN**
 Mustafina Str. 7/2
KAZ-470046 Karaganda
 Phone: +7 7212 / 50 11 50
 Fax: +7 7212 / 50 11 50

MIDDLE EAST REPRESENTATIVES

ILAN & GAVISH Ltd. **ISRAEL**
 24 Shenkar Str., Kiryat Arie
IL-49001 Petah-Tiqva
 Phone: +972 (0)3 / 922 18 24
 Fax: +972 (0)3 / 924 0761

TEXEL ELECTRONICS Ltd. **ISRAEL**
 2 Ha'umanut, P.O.B. 6272
IL-42160 Netanya
 Phone: +972 (0)9 / 863 39 80
 Fax: +972 (0)9 / 885 24 30

CEG INTERNATIONAL **LEBANON**
 Cebaco Center/Block A Autostrade DORA
Lebanon - Beirut
 Phone: +961 (0)1 / 240 430
 Fax: +961 (0)1 / 240 438

AFRICAN REPRESENTATIVE

CBI Ltd. **SOUTH AFRICA**
 Private Bag 2016
ZA-1600 Isando
 Phone: +27 (0)11 / 928 2000
 Fax: +27 (0)11 / 392 2354