



MOTORTRONICS™

Solid State AC Motor Control

VMX-Synergy Plus™

IEC - USER MANUAL

200 - 600V, 17 - 500 Amps



- Removable 3.5" Color Touch Screen rated IP66/N4X
- 42 Smart Application profiles - easy setup in 1 minute
- Auto Pedestal to control spinning motors
- Built-in iERS – intelligent Energy Recovery System
- Advanced motor protection with memory
- Life Time Event Logging Diagnostics
- Metering for power, voltage and current
- Integral Bypass



Contents

1. Safety	5
1.1 Important information	5
2. Mechanical Installation	7
2.1 Mounting	7
2.2 Requirements for an Enclosure	7
2.3 Enclosure Ventilation	7
2.4 Enclosure Internal Clearances	8
2.5 Altitude De-rate	8
2.6 Temperature De-rate	8
2.7 Dimensions	9
2.7.1 VMX-SGY-I-17 to VMX-SGY-I-100 (Size 1)	9
2.7.2 VMX-SGY-I-132 to VMX-SGY-I-195 (Size 2)	9
2.7.3. VMX-SGY-I-242 to VMX-SGY-I-361 (Size 3)	10
2.7.4 VMX-SGY-I-430 to VMX-SGY-I-500 (Size3)	10
2.8 Environmental Data	11
2.9 Key to External Features	12
3. Electrical Installation	13
3.1 Warnings	13
3.1 Terminal Layout	14
3.2 Terminal Descriptions	15
3.3 Supply Connections	16
3.4 Control Wiring	17
3.4.1 Three Wire Control	17
3.4.2 User Programmable Control	18
3.4.3 Reversing Configuration	19
3.4.4 Sequential Soft Start Diagram	20
4. Ratings and Technical Information	21
4.1 Rating Table	21
4.2 EN 60947-4-2 Product Information	22
4.3 Sizing Guide	23
4.3.1 In-Line Connection	23
4.3.2 In-Delta Connection	24
4.4 Short Circuit Protection	25
4.4.1 Size 1	25
4.4.2 Size 2 and 3	25
4.5 Electronic Overload Relay	26
4.6 Conductor Size and Torque Requirements	26
4.7 Model Number Description	27

4.8 Temperature and Altitude De-rate	27
5. Operation	28
5.1 Configuration and Parameters	28
5.1.1 Features	28
5.2 On Screen Menus	29
5.3 Auto Setup Example	30
5.4 Auto-Setup Parameter Settings	31
5.5 Auto Reset Function	33
5.5.1 Mapping Auto Reset Status to Digital Outputs	35
5.5.2 Two-Wire, Three-Wire and Communications Control	36
5.5.3 Control Supply Loss	36
5.5.4 Modbus/Communications	36
5.5.5 Overload Trip	36
5.5.6 Remote Start on Trip	36
5.5.7 Hand/Auto	36
5.6 Auto Reset Timing Diagrams	37
Fig 5.6.1: Auto Reset - Two Wire -Three Phase Supply Loss	37
Fig 5.6.2 Auto Reset - Two Wire - Control Supply Loss	38
Fig 5.6.3 Auto Reset - Three Wire - Three Phase Supply Loss	39
Fig 5.6.4 Auto Reset - Three Wire - Control Supply Loss	40
Fig 5.6.5 Auto Reset - Two Wire – Overload	41
5.7 Parameters for Touchscreen Interface	42
5.7.1 ‘Advanced’ Category	42
5.7.2 ‘Input/Output’ (I/O) Category	46
5.7.3 ‘Monitor’ Category	48
5.7.4 ‘Log’ Category	49
5.7.5 ‘Device’ Category	51
5.8 Auto Setup Menu	52
5.9 Advanced Menu	54
5.10 Input/Output Menu	78
5.11 Monitor Menu	84
5.12 Log Menu	92
5.13 Device Menu	110
5.14 Functional Summaries	115
5.14.1 Automatic Settings	115
5.14.2 Low Current Protection	116
5.14.3 Current Limit	116
5.14.4 Shearpin	117
5.15 Touchscreen Menu Paths	118

5.15.1 Advanced Menu	118
5.15.2 Input / output Menu	121
5.15.3 Monitor	122
5.15.4 Log Menu	123
6 Trip and Fault Codes	124
6.1 Trip Code Descriptions	124
6.2 Fail-Safe Codes	128
6.2.1 Main Board Trip Operation 2 (2402 – 2436)	128
6.2.2 Logging Operation 2 Trip (2601 – 2603)	129
7 Communication	130
7.1 Modbus RTU Serial Communications.....	130
7.1.1 Modbus RTU Connection	130
7.1.2 Modbus Communications Configuration	131
7.1.3 Message Structure for RTU Mode	132
7.1.4 Supported Functions.....	132
Read Holding Registers	133
Write Single Register	133
Write Multiple Registers	134
Memory Map	134
Message Timing	135
7.2 Modbus Register Address Aliasing.....	136
Appendix 1	139
A1.0 Updating VMX-Synergy Plus™ Firmware	139
A1.1 Updating VMX-Synergy Plus™ Keypad Firmware.....	140
Appendix 2	141
A2.0 Remote Installation of the Touchscreen	141

Safety

1. Safety

1.1 Important information

Installers should read and understand the instructions in this guide prior to installing, operating and maintaining the soft start. The following symbols may appear in this guide or on the soft start to warn of potential hazards or to draw attention to certain information.

Dangerous Voltage



Indicates the presence of a hazardous voltage which could result in personal injury or death.

Tension dangereuse

Indique la présence d'une tension dangereuse qui peut entraîner des blessures ou la mort.

Warning/ Caution



Indicates a potential hazard. Any instructions that follow this symbol should be obeyed to avoid possible damage to the equipment, and personal injury or death.

Avertissement/Mise en garde

Indique un danger potentiel. Toutes les instructions suivant ce symbole doivent être observées, afin d'éviter les dommages de l'équipement et les blessures ou la mort.

Protective Earth (Ground)



Indicates a terminal which is intended for connection to an external conductor for protection against electric shock in case of a fault.

Mise à la terre (Masse)

Indique une borne dont l'usage prévu est d'être connecter à conducteur externe pour assurer la protection contre les chocs électriques en cas de défauts.

Caution Statements

The examples and diagrams in this manual are included solely for illustrative purposes. The information contained in this manual is subject to change at any time and without prior notice. In no event will responsibility or liability be accepted for direct, indirect or consequential damages resulting from the use or application of this equipment.

Mises en garde

Les exemples et les schémas de ce manuel ne sont donnés qu'à titre illustratif. Les informations présentées dans ce manuel peuvent être modifiées sans avis préalable. En aucun cas nous n'assumons la responsabilité ou l'obligation pour les dommages directs, indirects ou consécutifs qui résultent de l'utilisation ou application de cet équipement.

Short Circuit

Motortronics soft starts are not short circuit proof. After severe overload or short circuit, the operation of the soft start should be fully tested by an authorised service agent.

Court-circuit

Les démarreurs progressifs Motortronics Une sont pas à l'épreuve des courts-circuits. Après une forte surcharge ou un court-circuit, le fonctionnement du démarreur progressif doit être intégralement vérifié par un agent de maintenance agréé.

Safety



VMX-Synergy™ Plus soft starts contain dangerous voltages when connected to the mains supply. Only qualified personnel that have been completely trained and authorised, should carry out installation, operation and maintenance of this equipment.

Les démarreurs progressifs VMX-Synergy™ Plus contiennent des tensions dangereuses, lorsqu'ils sont connectés à la tension secteur. Les activités d'installation, d'utilisation et d'entretien de cet équipement doivent être effectuées par un personnel qualifié, dûment formé et habilité.

Installation of the soft start must be made in accordance with existing local and national electrical codes and regulations and have a minimum protection rating.

Le démarreur progressif doit être installé conformément au code local et nationale d'électricité et à la réglementation en vigueur, et il doit avoir un indice de protection minimal.

It is the responsibility of the installer to provide suitable grounding and branch circuit protection in accordance with local electrical safety codes.

Il appartient à l'installateur d'assurer la mise à la terre et la protection du circuit de branchement, conformément au code de sécurité électrique local.

This soft start contains no serviceable or re-usable parts.

Ce démarreur progressif ne contient pas de pièces réparables ou réutilisables

The STOP function of the soft start does not isolate dangerous voltages from the output of the soft start. An approved electrical isolation device must be used to disconnect the soft start from the incoming supply before accessing electrical connections.

La fonction STOP du démarreur progressif n'isole pas les tensions dangereuses en sortie du démarreur progressif. Avant d'accéder aux raccordements électriques, il faut utiliser un dispositif d'isolation électrique approuvé pour déconnecter le démarreur progressif de la tension d'entrée.

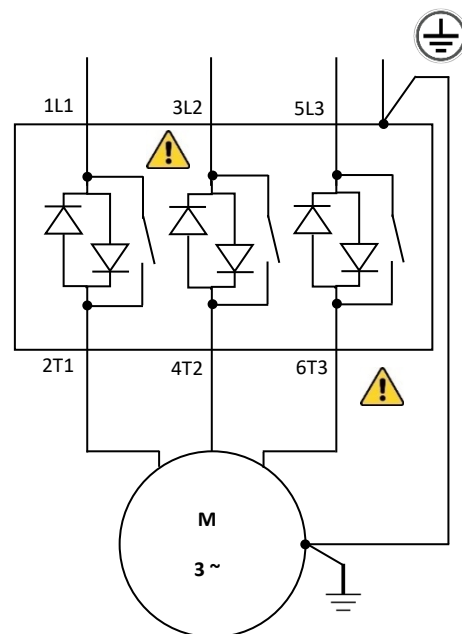

Installation

2. Mechanical Installation

2.1 Mounting

The unit must be fixed to a flat, vertical surface using the mounting holes (or slots) on its base-plate. The mechanical outline diagrams give the dimensions and mounting hole positions for each model. Ensure that:

- The orientation of the unit has the 'TOP' uppermost.
- The location allows adequate front access.
- You can view the touchscreen.
- Do not install other equipment that generates significant heat close to the soft starter.

2.2 Requirements for an Enclosure

For a typical industrial environment, an enclosure would provide the following:

- A single location for the unit and its protection/isolation switchgear
- The safe termination of cabling and/or busbars

Means to effect proper air flow through the enclosure.

2.3 Enclosure Ventilation

When fitting VMX-Synergy™ Plus into a cabinet, ventilation must be provided if the heat output of the unit is greater than the cabinet will dissipate. Use the following formula to determine the fan requirement. An allowance has been incorporated into the formula so that the figure for Q is the air delivery in the fan suppliers' data.

Heat dissipated can be approximated with the formulas:

Starting

Watts (VMX-Synergy Plus™) = start current(A) x start time(s) x number of starts per hour/1200

iERs Disabled

Watts (VMX-Synergy Plus™) = (VMX-Synergy Plus™ current rating) x 0.6

iERs Enabled

The maximum power dissipation occurs when energy saving and the iERS is turned on

Watts (VMX-Synergy Plus™) = (VMX-Synergy Plus™ current rating) x 1.5

$$Q = \frac{4 \times Wt}{(T_{max} - T_{amb})}$$

Where:

Q = volume of air (cubic metres per hour-m³/h)

Wt = Heat produced by the unit and all other heat sources within the enclosure (Watts)

T_{max} = Maximum permissible temperature within the enclosure (50°C for a fully rated VMX-Synergy Plus™)

T_{amb} = Temperature of the air entering the enclosure (°C).

If CFM is preferred, substitute °F for °C. Q is now in CFM

Installation

2.4 Enclosure Internal Clearances

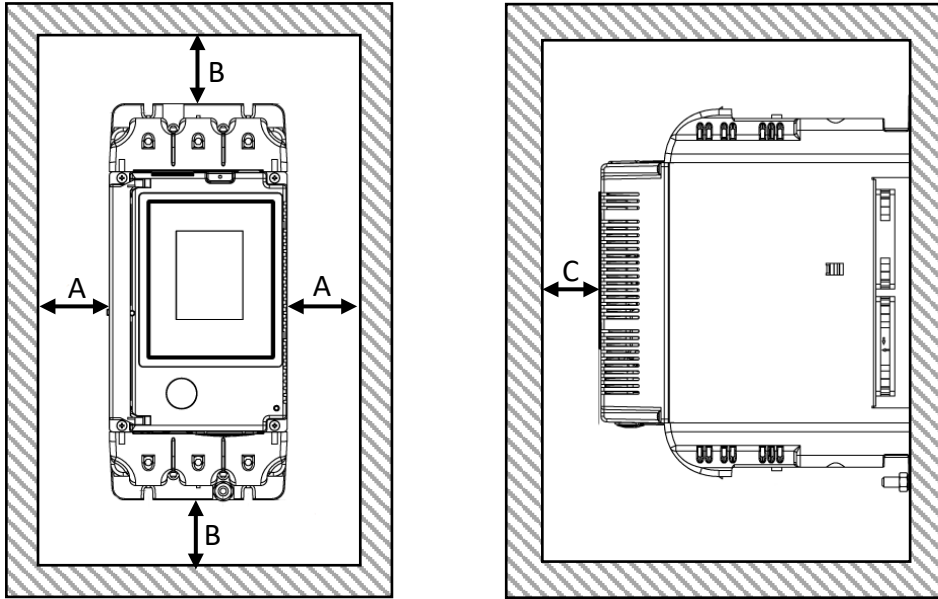

Model	A		B		C	
	mm	inch	mm	inch	mm	inch
VMX-SGY-I-17 to VMX-SGY-I-100	25	0.98	75	2.95	25	0.98
VMX-SGY-I-132 to VMX-SGY-I-195	40	1.57	100	3.93	25	0.98
VMX-SGY-I-242 to VMX-SGY-I-500	60	2.36	125	4.92	25	0.98

2.5 Altitude De-rate

Altitude above sea level 1000m (**3281ft**). Above 1000m de rate by 1% of VMX-Synergy Plus™ Ie per 100m (328ft) to a maximum altitude of 2000m (**6562ft**).

2.6 Temperature De-rate

VMX-SGY-I-17 to VMX-SGY-I-500

-20°C [**-4°F**] to 50°C [**122°F**]; above 50°C derate linearly by 4% of VMX-Synergy Plus™ Ie per °C to a maximum of 60°C (**140°F**)

Installation

2.7 Dimensions

2.7.1 VMX-SGY-I-17 to VMX-SGY-I-100 (Size 1)

Dimensions

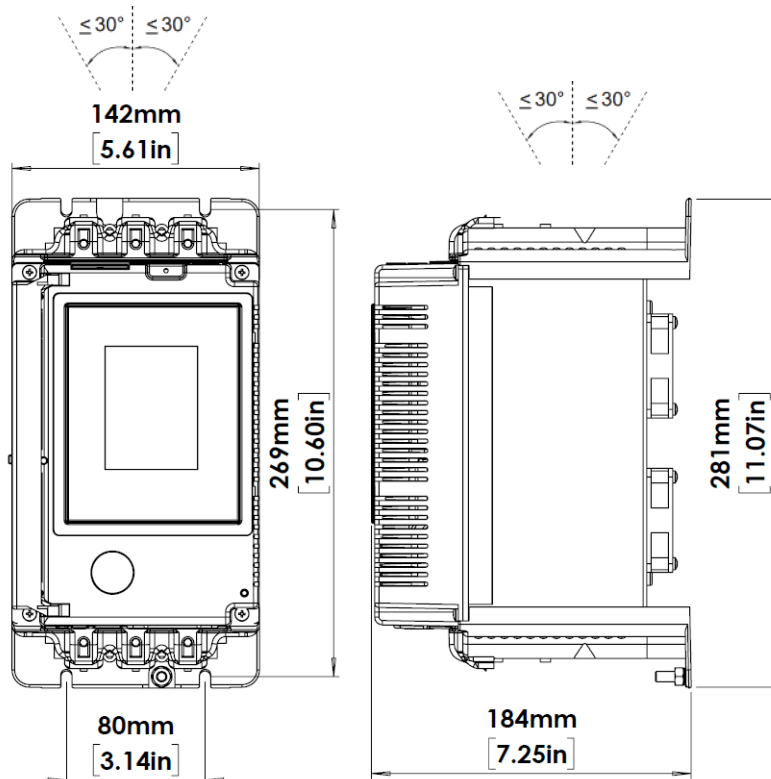

VMX-SGY-I-17 to VMX-SGY-I-29
Weight = 3.9 kg (8.6 lbs)

VMX-SGY-I-35 to VMX-SGY-I-100
Weight = 4.2 kg (9.26 lbs)

2.7.2 VMX-SGY-I-132 to VMX-SGY-I-195 (Size 2)

Dimensions

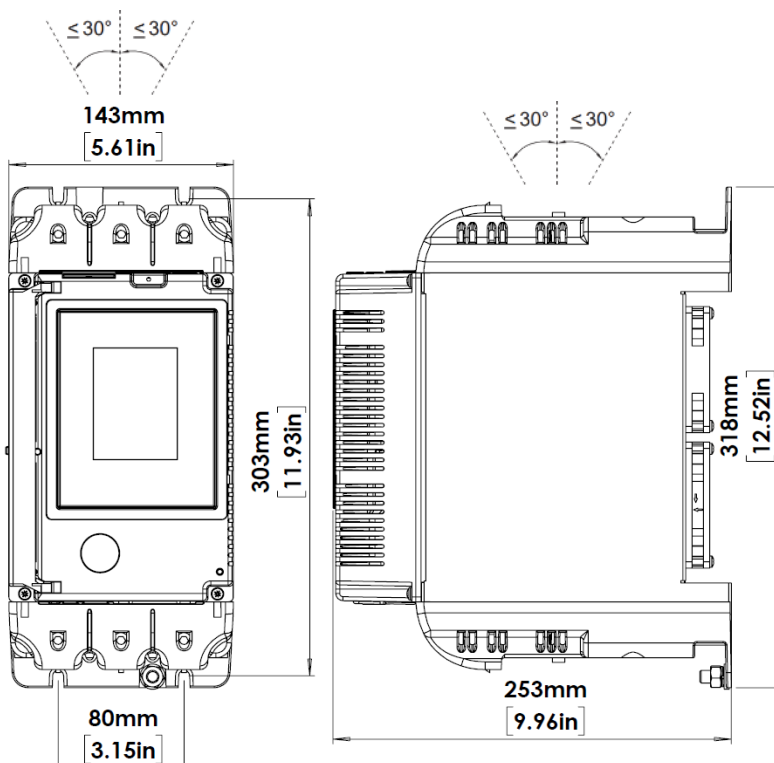

VMX-SGY-I-132
Weight = 6.7 kg (14.78 lbs)

VMX-SGY-I-160 to VMX-SGY-I-195
Weight = 7.0 kg (15.44 lbs)

Installation

2.7.3. VMX-SGY-I-242 to VMX-SGY-I-361 (Size 3)

Dimensions

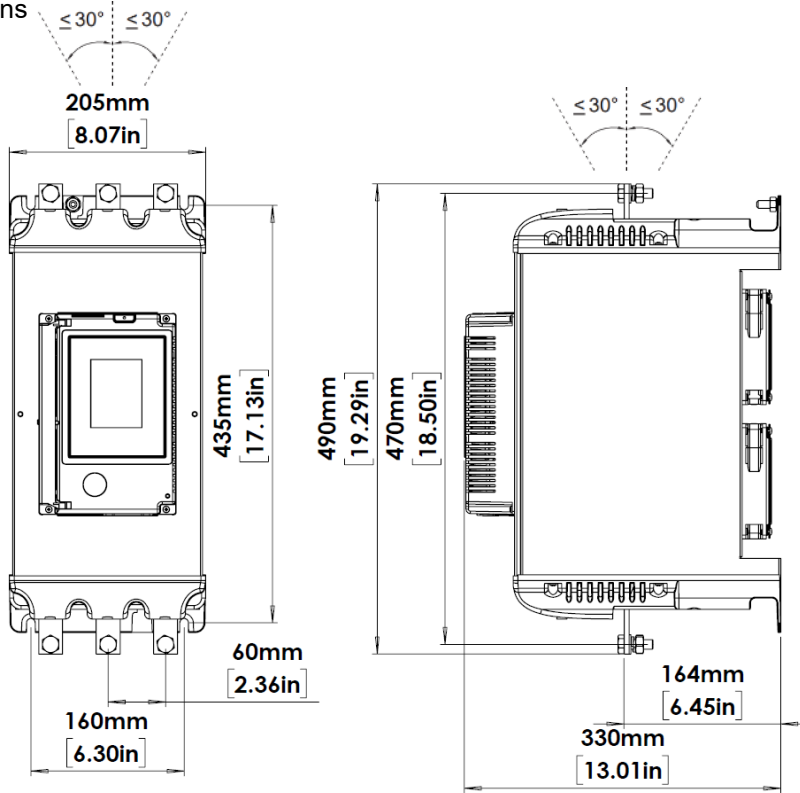

VMX-SGY-I-242 to VMX-SGY-I-361
Weight = 17.0 kg (37.5 lbs)

2.7.4 VMX-SGY-I-430 to VMX-SGY-I-500 (Size3)

Dimensions

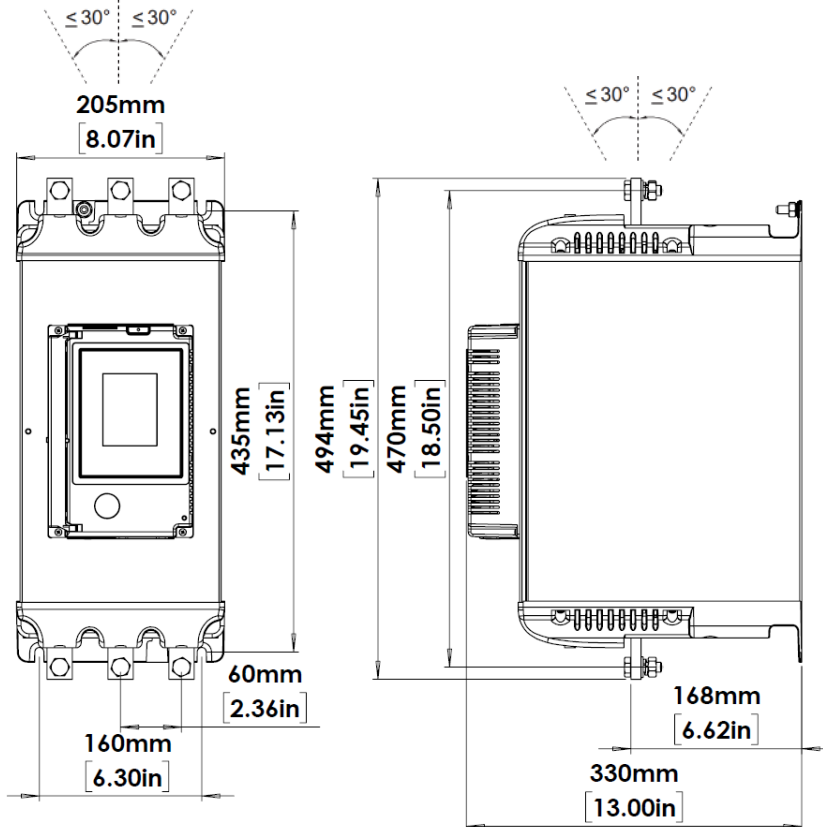

VMX-SGY-I-430 to VMX-SGY-I-500
Weight = 22 kg (48.5 lbs)

Installation

2.8 Environmental Data

Model (VMX-SGY-I-)	17	22	29	35	41	55	66	80	100
Frame Size	1								
Heat output @ FLC (W)	25.5	33	43.5	52.5	61.5	82.5	99	120	150
Weight kg [lb]	3.9 [8.6]			4.2 [9.26]					
Model (VMX-SGY-I-)	132	160	195	242	302	361	430	500	-
Frame Size	2			3					-
Heat output @ FLC (W)	198	240	293	363	453	542	645	750	-
Weight kg [lb]	6.7 [14.78]	7.0 [15.44]		17.0 [37.5]			22.0 [48.5]		-
Model (VMX-SGY-I-)	17 to 500								
Ambient Operating Temp.	-20°C [-4°F] to 50°C [122°F]; above 50°C derate linearly by 4% of VMX-Synergy Plus™ Ie per °C to a maximum of 60°C (140°F)								
Transportation and Storage Temperature	-25°C to 70°C [-13°F to 158°F] continuous								
Humidity	Max 85% non-condensing, not exceeding 50% @ 40°C [104°F]								
Maximum Altitude	1,000m [3281ft]; above 1000m derate by 1% of VMX-Synergy Plus™ Ie per 100m (328ft) to a maximum altitude of 2,000m (6562ft)								
Environmental Rating	Main Circuit: IP00 (IP20 with optional finger guards for sizes 1&2 only); Control Circuit: IP20; No corrosive gases permitted								

Installation

2.9 Key to External Features

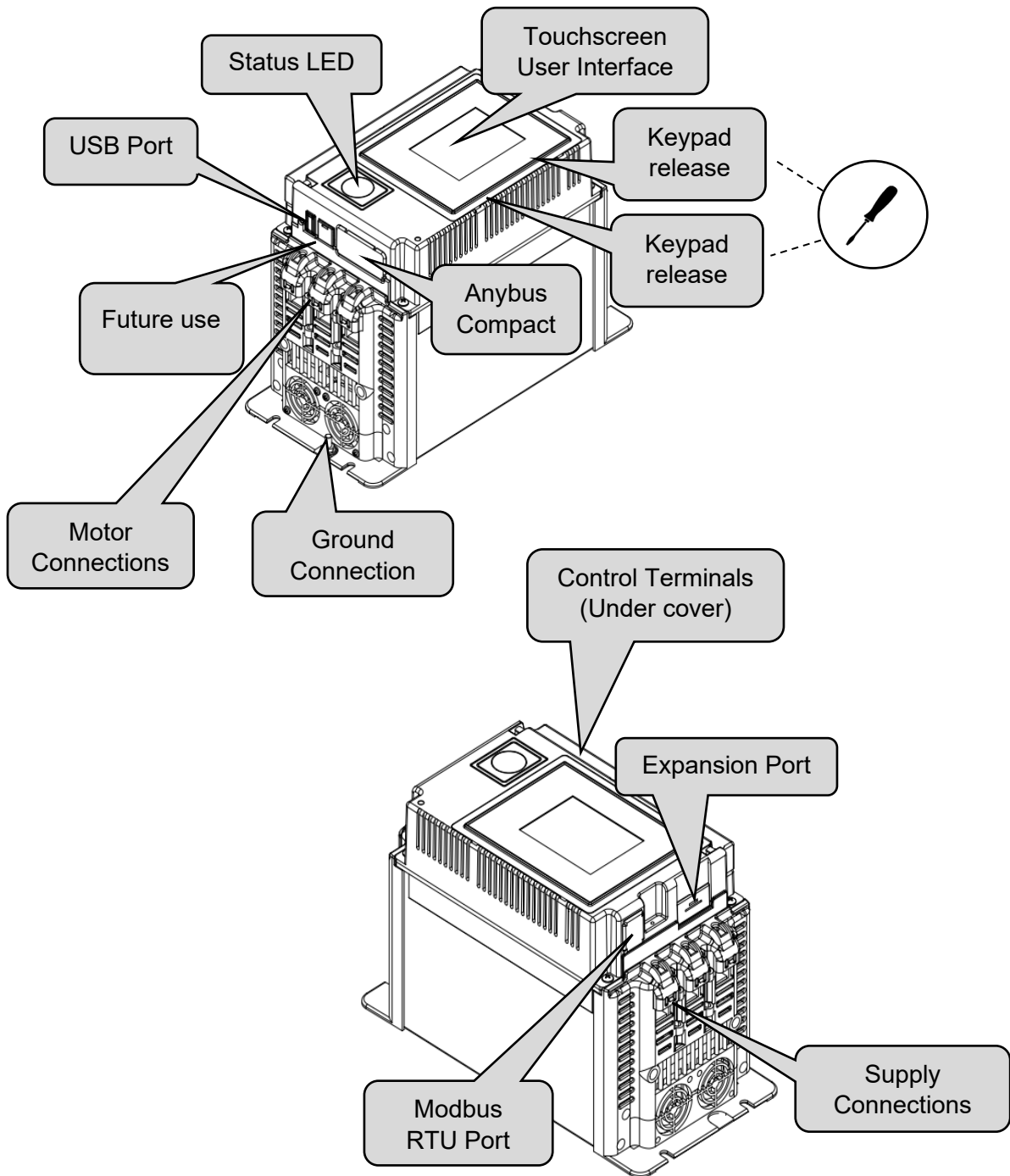

Installation

3. Electrical Installation

3.1 Warnings



Isolation

Caution: VMX-Synergy Plus™ uses semiconductor devices in the main circuit and is not designed to provide isolation. For this reason, isolation means must be installed in the supply circuit in accordance with the appropriate wiring and safety regulations.



Electrical Control Supply Requirements

All electrical connections are made to power input and output terminals, control terminals and an earth stud.



Access

No user accessible internal parts.



Fuse Protection

The Mains Supply and the Control Supply each require protection. Although all VMX-Synergy Plus™ units have electronic overload protection for the Soft Start, the installer should always fit fuses or circuit breakers, between the unit and the Mains Supply, not between the unit and the motor. Semiconductor fuses can be supplied as an option for short-circuit protection of the semiconductors. It is the responsibility of the installer and system designer/specifier to ensure that the required standards or regulations are complied with.



Safety

VMX-Synergy Plus™ soft starters contain hazardous voltages when connected to the electrical power supply. Only qualified personnel who are trained and authorized should carry out installation, operation and maintenance of this equipment. Refer to and carefully follow all of the 'Warnings' section at the start of this user manual, as well as other warnings and notes throughout the manual.

Installation

3.1 Terminal Layout

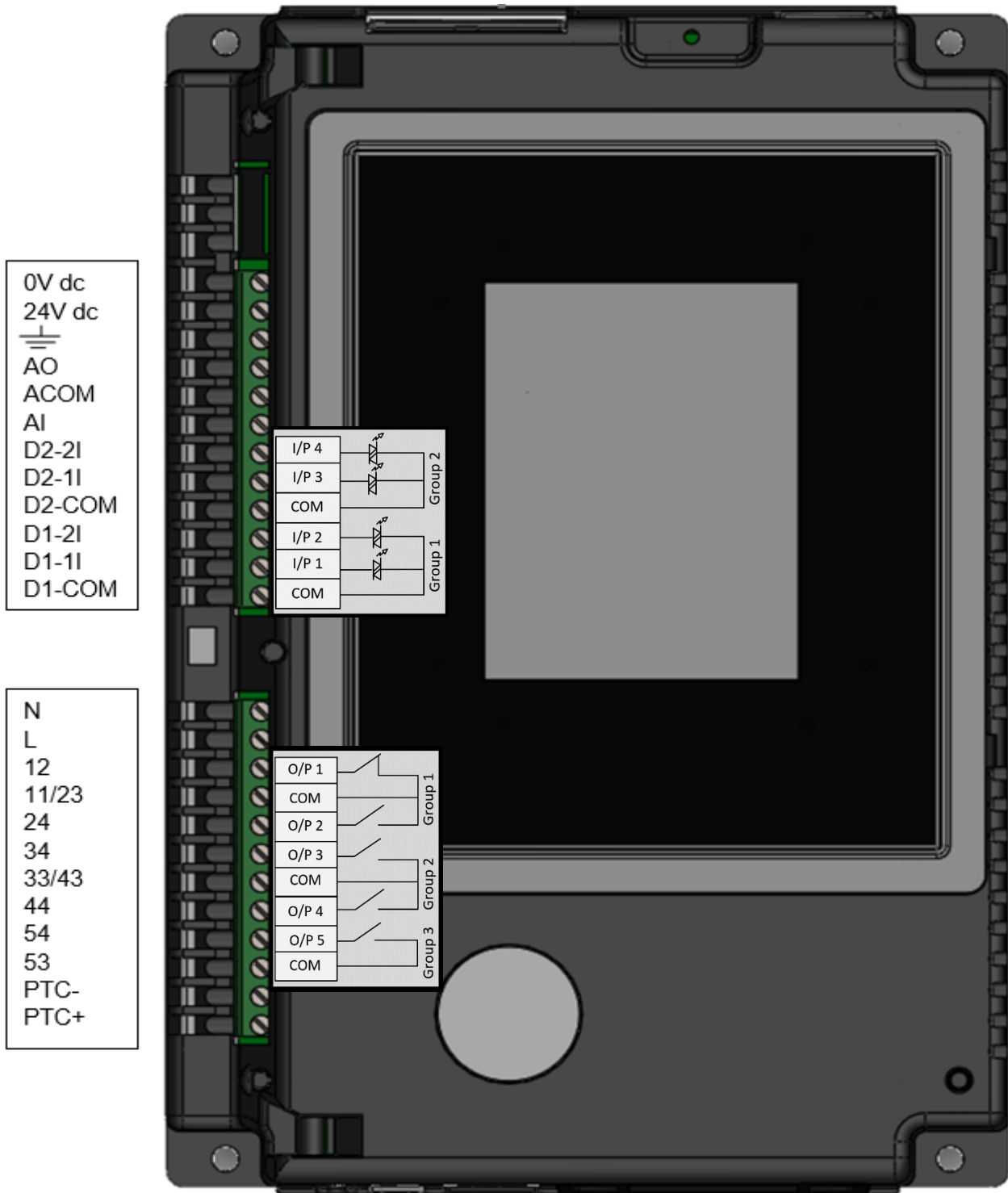

Control Power Consumption

VMX-SGY-I-17 to VMX-SGY-I-361 = 60W

VMX-SGY-I-430 to VMX-SGY-I-500 = 120W

Installation

3.2 Terminal Descriptions

Terminal Name	Description	Programmable	Default	Rating	Notes
0V dc	Control Supply			See Table 1, Us	#3
24V dc					
	Signal ground				
AO	Analog Output	0-10V or 4-20mA			
ACOM	Analog Common				
AI	Analog Input	0-10V or 4-20mA			
D2-2I	Digital Input 4 - Group 2	See Table 1, Uc	None		#2
D2-1I	Digital Input 3 - Group 2	See Table 1, Uc	Reset		#2
D2-COM	Digital Input - Group 2 Common				#2
DI-2I	Digital Input 2 - Group 1	See Table 1, Uc	None		#1
DI-1I	Digital Input 1 - Group 1	See Table 1, Uc	Start / Stop		#1
D1-COM	Digital Input - Group 1 Common				#1
N	Control supply			See Table 1, Us	#3
L					
12	Digital Output 1 - Group 1 relay N/C	Yes	Fault	230VAC 1A AC15	
11 / 23	Digital Output - Group 1 Common				
24	Digital Output 2 - Group 1 relay N/O	Yes	Fault	230VAC 1A AC15	
34	Digital Output 3 - Group 2 relay N/O	Yes	Running	230VAC 1A AC15	
33 / 43	Digital Output - Group 2 Common				
44	Digital Output 4 - Group 2 relay N/O	Yes	End of Start	230VAC 1A AC15	
54	Digital Output 5 - Group 3 relay N/O	Yes	Running	230VAC 3A AC15	
53	Digital Output 5 - Group 3 Common				
PTC-	3 x PTC in series (130°C)				
PTC+	3 x PTC in series (130 °C)				

#1	The programmed digital input setting on D1-COM, D1-1I, D1-2I must correspond to the voltage applied to these terminals to avoid risk of damage to the equipment. Afin d'éviter d'endommager l'équipement, le réglage de l'entrée numérique programmé sur D1-COM, D1-1I, D1-2I doit correspondre à la tension appliquée à ces bornes.
#2	The programmed digital input setting on D2-COM, D2-1I, D2-2I must correspond to the voltage applied to these terminals to avoid risk of damage to the equipment. Afin d'éviter d'endommager l'équipement, le réglage de l'entrée numérique programmé sur D2-COM, D2-1I, D2-2I doit correspondre à la tension appliquée à ces bornes.
#3	The control supply can be 110 to 230Vac applied to the N, L terminals or 24Vdc applied to the 0Vdc, 24V input terminals. The correct voltage as specified must only be applied to one of these supply inputs to avoid risk of damage to the equipment. L'alimentation contrôle peut être 110 à 230 Vca, appliquée aux bornes N et L, ou 24 Vcc, appliquée aux bornes d'entrée de 0 Vcc, 24 V. Afin d'éviter d'endommager l'équipement, la tension appropriée selon les indications ne doit être appliquée qu'à une entrée d'alimentation.
#4	Refer to VMX-Synergy Plus User Manual for factory default settings. / Référez au la Manuel de Programmation pour des paramètres par défaut d'usine

Model No (s)	U _S (+10% -15%)	U _C (+10% -15%)	Notes
VMX-SGY-I-17-6-01 to VMX-SGY-I-361-6-01	110-230Vac or 24Vdc	110Vac or 230Vac or 24Vdc 230Vac factory default. 230Vac défaut d'usine #4	The system can have either a 110/230Vac mains or 24Vdc input NOT both. Le système peut avoir soit une alimentation principale de 110/230Vac ou de 24 Vdc, mais en aucun cas les deux simultanément
VMX-SGY-I-430-6-02 to VMX-SGY-I-500-6-02	110Vac		
VMX-SGY-I-430-6-03 to VMX-SGY-I-500-6-03	230Vac		

Table 1: Interface Control Voltages 2 Amp supply (Continuous)

24Vdc Supply Specification: 24Vdc 60W. Residual ripple 100mV. Spikes/switching peaks 240mV.
Turn On/Off no overshoot of V out. Overvoltage protection output voltage must be clamped to <30Vdc

Installation

3.3 Supply Connections

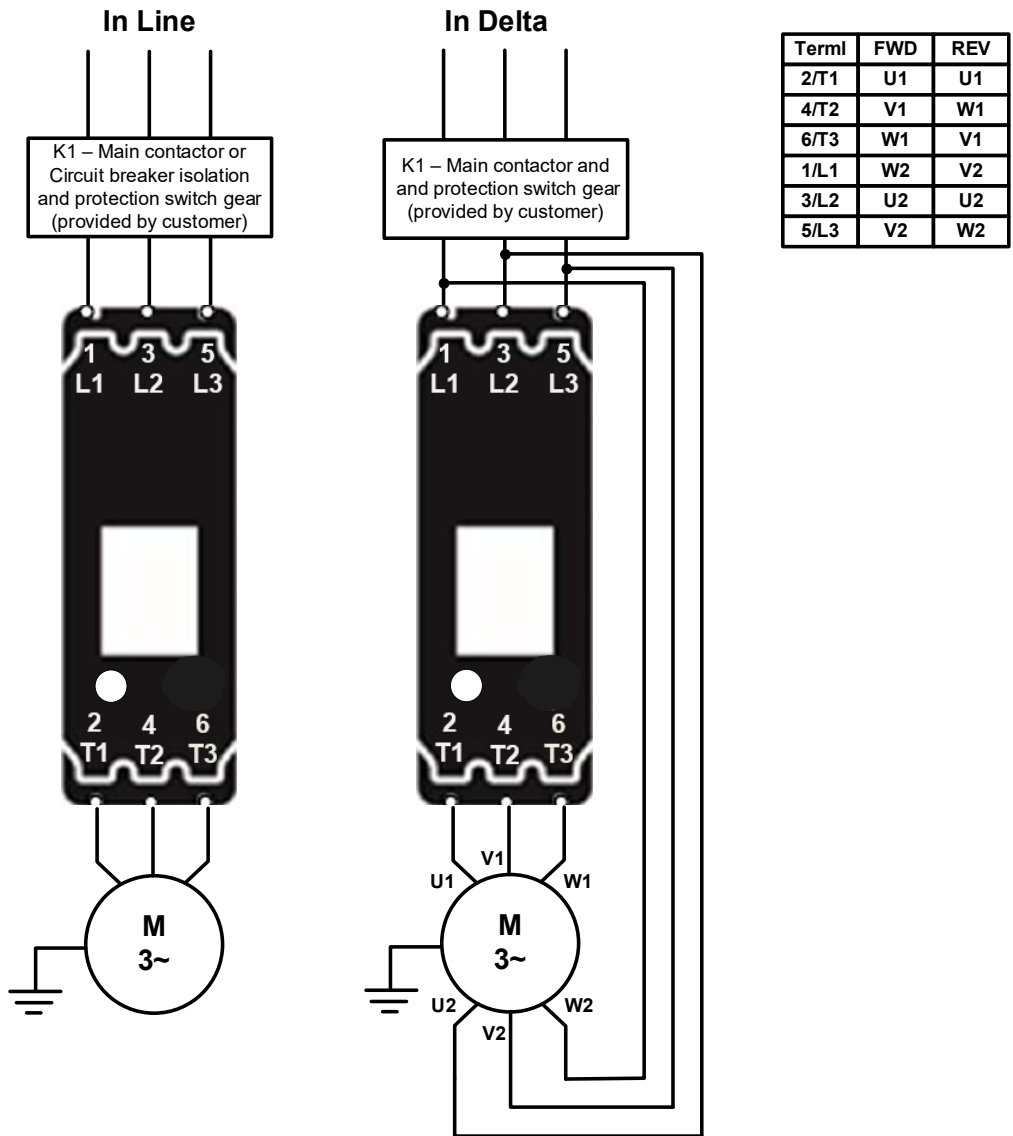

<p>! For suitable short circuit protection devices (SCPD's) see short Circuit Protection in the Technical Information/ standards section of this guide.</p> <p>Pour un dispositif de protection approprié contre le court-circuit, voir la protection contre le court-circuit dans la section « Informations techniques/normes » du présent guide.</p>	<p>! For wire size and torque requirements see Technical Information/ standards section of this guide.</p> <p>Pour les dimensions de câble et les besoins en couple, voir la section « Informations techniques/normes » du présent guide.</p>	<p>! In Delta For this configuration applying the equation.</p> <p>$VMX\text{-Synergy Plus } I_e = I_e (\text{motor}) / \sqrt{3}$</p> <p>Allows lower current rating VMX-Synergy Plus than the motor.</p> <p>The contactor K1 can also be connected inside the delta circuit.</p> <p>When connected in the delta $K1 \text{ current rating} = I_e (\text{motor}) / \sqrt{3}$</p>	<p>! En Delta Pour cette configuration, appliquer l'équation suivante:</p> <p>$VMX\text{-Synergy Plus } I_e = I_e (\text{moteur}) / \sqrt{3}$</p> <p>Cela permet le courant nominal inférieur de VMX-Synergy Plus par rapport au moteur.</p>
---	--	---	--

Installation

3.4 Control Wiring



The programmed digital input settings for D1COM, D1-1I, D1-2I, and D2COM, D2-1I, D2-1I must correspond to the voltage applied to these terminals to avoid risk of damage to the equipment.



The control supply can be 110 to 230Vac applied to the N, L terminals or 24Vdc applied to the 0Vdc, 24V input terminals. The correct voltage as specified must only be applied to one of these supply inputs to avoid risk of damage to the equipment.

3.4.1 Three Wire Control

3 Wire Control Diagram

110/230Vac control supply (U_s) and digital input (U_c) programming.

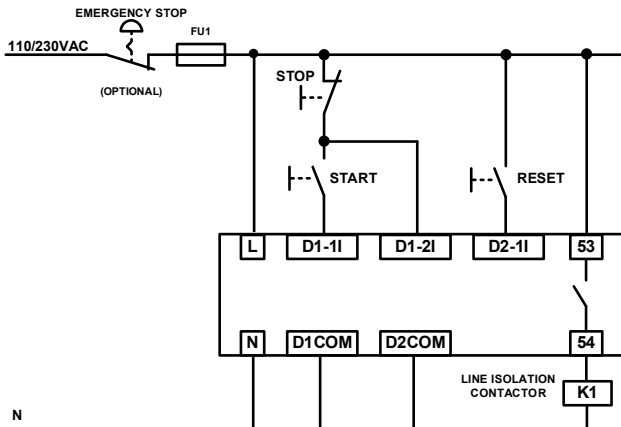

3 Wire Control Diagram

24Vdc control supply (U_s) and digital input (U_c) programming.

(VMX-SGY-I-17 to VMX-SGY-I-361)

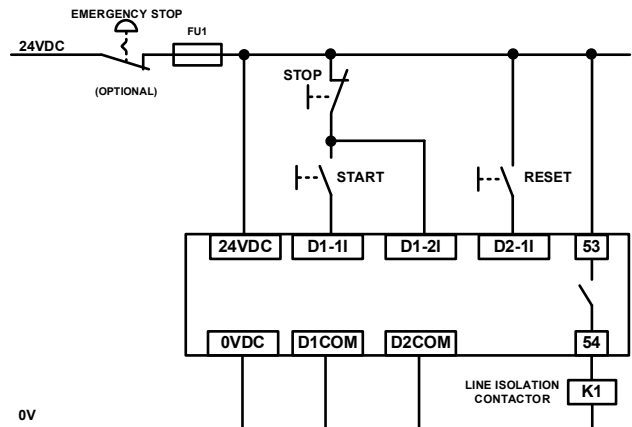

CAUTION	
#1	<p>REFER to TABLE 1 for input control voltages. These recommended wiring diagrams are specifically where the control supply voltage (U_s) is identical to the control circuit voltage (U_c) and not to be supplied separately. Other wiring configurations must also be in accordance with existing local and national codes and regulations.</p> <p>RÉFÉRER au TABLEU 1 à la page 12 pour des tensions de contrôle d'entrée. Ces schémas de câblage sont recommandées spécifiquement lorsque la tension d'alimentation de commande (U_s) est identique à la tension du circuit de commande (U_c). U_s et U_c ne doivent pas être alimentés séparément. Toutes les configurations de câblage doivent également être en conformité avec les codes et les règlements locaux et nationaux en vigueur.</p>
#2	<p>Power factor correction capacitors must NOT be positioned between the soft start and the motor or there is a risk of damaging thyristors due to current peaks.</p> <p>Condensateurs de correction de facteur de puissance NE doivent pas être placés entre le moteur et le démarreur progressif ou il y a un risqué d'endommager les thyristors en raison des pics de courant.</p>

Installation

3.4.2 User Programmable Control

110/230Vac (US) and (UC) user programmable control diagram

24Vdc (US) and (UC) user programmable control diagram (VMX-SGY-I-17 to VMX-SGY-I-361)

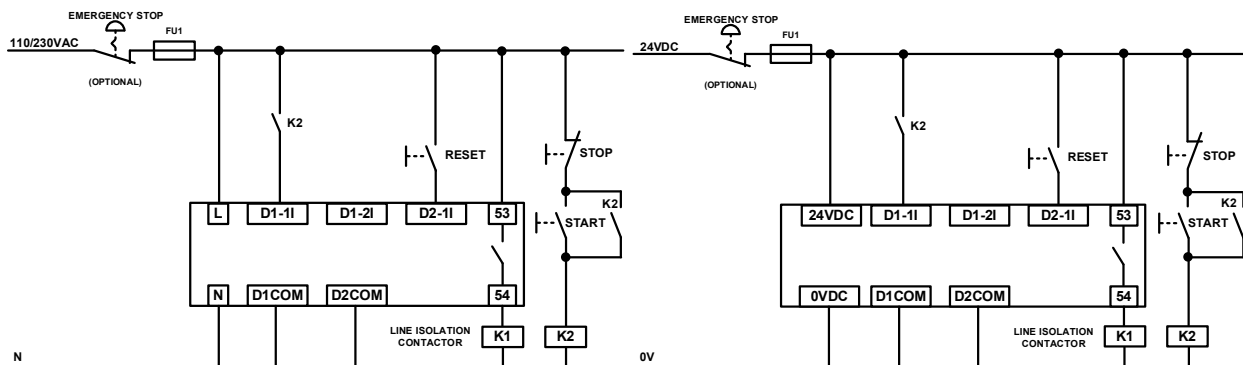

User programmable inputs are full programmable	
D1 – 1I = High Start / Low Stop	1) Optional high reset. If this reset is required ensure “User Programmable” is selected in the control method menu found in the Digital Inputs menu. If you would prefer the reset to work by removing and reapplying the Start Signal on D1 - 1I then select “Two wire control” in the control method menu.
D1 – 2I = None	
D2 – 1I = High Reset	

Installation

3.4.3 Reversing Configuration

Soft start reversing circuit without soft stop, it shows the main components required. You must follow your local wiring and electrical regulations when constructing this circuit, set to 'User Programmable' control.

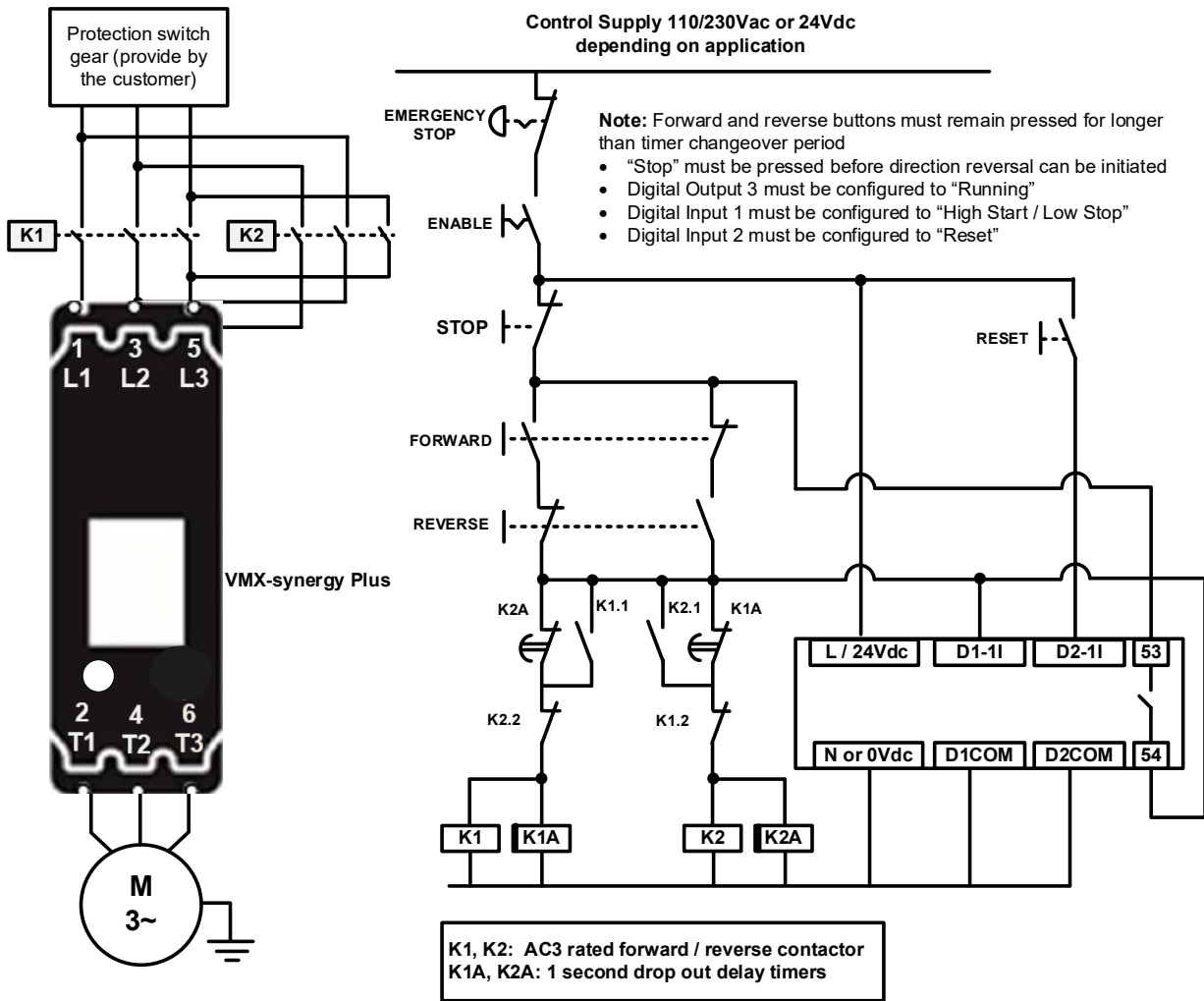

These are the major components of the system. Local wiring regulations should be observed. Note the use of timers to ensure that a reversed voltage is not applied to the starter/motor before the motor field has had some chance to reduce to zero. The thermal capabilities of VMX-Synergy™ should be considered.

Installation

3.4.4 Sequential Soft Start Diagram

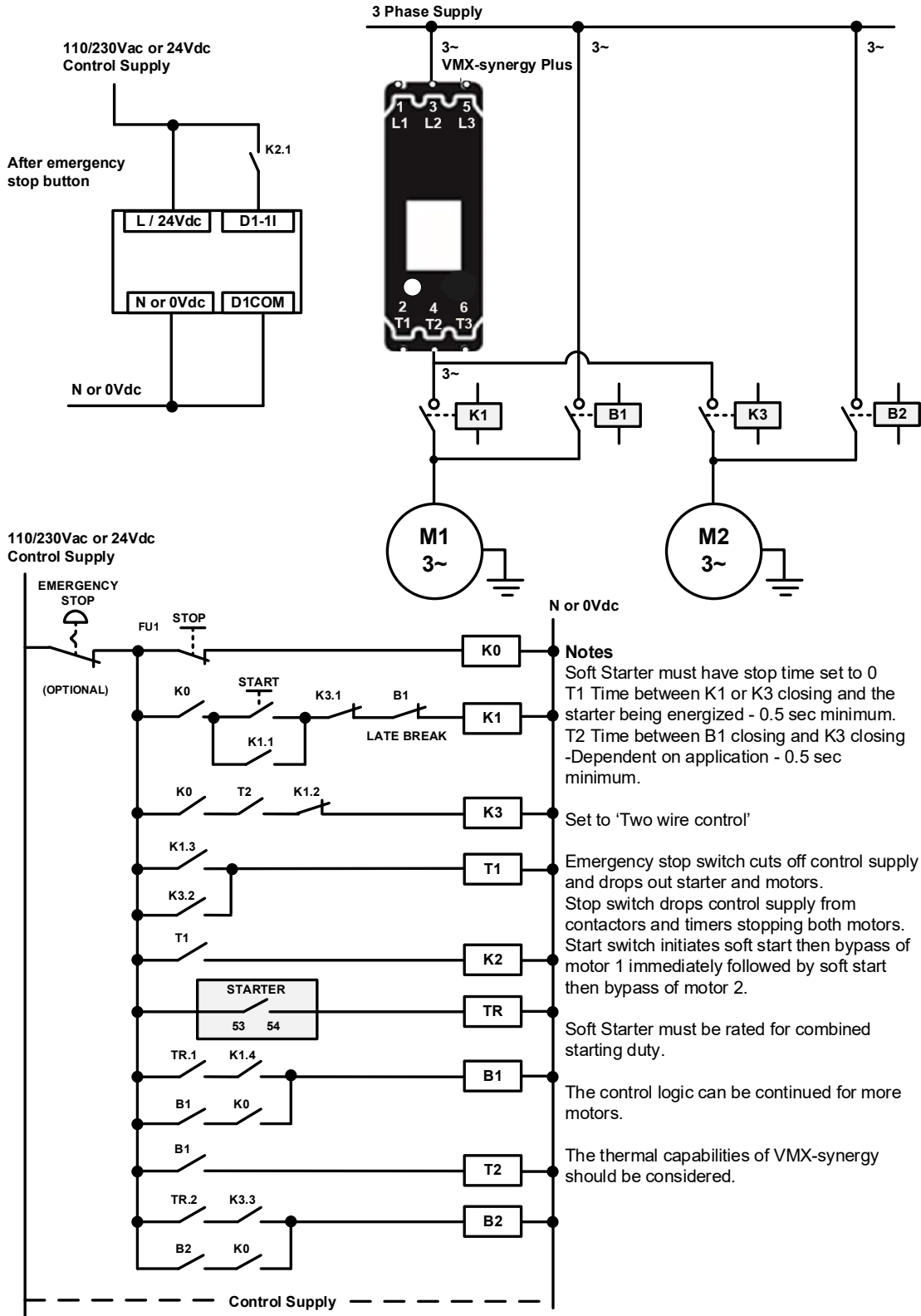

CAUTION

REFER to Section 3.2 for input control voltage.

RÉFÉRER au Section 3.2 pour des tensions de contrôle d'entrée

Installation

4. Ratings and Technical Information

4.1 Rating Table

Minimum current ratings based on typical rated operation currents of motors for the corresponding rated operational powers.

Current rating optimised for kW@500V & HP@550-600V - Ref IEC 60947-4-1 Table G.1 where applicable.

Size 1,2 and 3

Type	I _e A ³⁾	kW ¹⁾			FLA A ³⁾	HP ²⁾					U _s
		230V	400V	500V		200V	208V	220-240V	440-480V	550-600V	
VMX-SGY-I-17-6-01	17	4	7.5	7.5	17	3	5	5	10	15	24VDC, 110VAC to 230VAC
VMX-SGY-I-22-6-01	22	5.5	11	11	22	5	5	5	15	20	
VMX-SGY-I-29-6-01	29	7.5	15	15	27	7.5	7.5	7.5	20	25	
VMX-SGY-I-35-6-01	35	7.5	18.5	22	34	10	10	10	25	30	
VMX-SGY-I-41-6-01	41	11	22	22	41	10	10	10	30	40	
VMX-SGY-I-55-6-01	55	15	30	37	52	15	15	15	40	50	
VMX-SGY-I-66-6-01	66	18.5	37	45	65	20	20	20	50	60	
VMX-SGY-I-80-6-01	80	22	45	55	77	20	25	25	60	75	
VMX-SGY-I-100-6-01	100	30	55	55	99	30	30	30	75	100	
VMX-SGY-I-132-6-01	132	37	75	90	125	40	40	40	100	125	
VMX-SGY-I-160-6-01	160	45	90	110	156	50	50	60	125	150	
VMX-SGY-I-195-6-01	195	55	110	132	192	60	60	75	150	200	
VMX-SGY-I-242-6-01	242	75	132	160	242	75	75	75	200	250	
VMX-SGY-I-302-6-01	302	90	160	200	302	100	100	100	250	300	
VMX-SGY-I-361-6-01	361	110	200	250	361	125	125	150	300	350	
VMX-SGY-I-430-6-02	430	132	250	250	414	150	150	150	350	450	110VAC
VMX-SGY-I-500-6-02	500	150	280	355	477	150	150	150	400	500	230VAC
VMX-SGY-I-430-6-03	430	132	250	250	414	150	150	150	350	450	
VMX-SGY-I-500-6-03	500	150	280	355	480	150	150	200	400	500	

1) Rated operational powers in kW as per IEC 60072-1 (primary series) corresponding to IEC current rating.

2) Rated operational powers in HP corresponding to FLA current rating according to UL508 and Table 430.250 of the National Electrical Code.

3) The I_e and FLA rating applies for a maximum surrounding air temperature of 50°C. Above 50°C de-rate linearly by 4% of I_e or FLA per °C to a maximum of 60°C.

Installation

4.2 EN 60947-4-2 Product Information

Rated operational voltages	U_e	200VAC to 600Vac		
Rated operational currents	I_e	See Rating Table		
Rating index		VMX-SGY-I-17 to VMX-SGY-I-361 Ie: AC-53a:3.5-17:90-5 VMX-SGY-I-430 to VMX-SGY-I-500 Ie: AC-53a:3.5-17:90-3		
Rated frequency/frequencies		50 - 60Hz \pm 5Hz		
Rated duty		Uninterrupted.		
Form designation		Form 1, Internally Bypassed		
Rated insulation voltage	U_i	600V		
Rated impulse withstand voltage	U_{imp}	Main circuit	6kV	
		Control supply circuit	4kV	
IP code		Main circuit	IP00 (IP 20 optional on VMX-SGY-I-17 to VMX-SGY-I-195)	
		Supply and Control circuit	IP20	
Overvoltage Category/Pollution Degree		III/3		
Humidity		Max 85% non-condensing, not exceeding 50% at 40°C		
Rated conditional short-circuit current and type of co-ordination with associated short circuit protective device (SCPD)		Type 1 co-ordination See Short Circuit Protection Tables for rated conditional short-circuit current and required current rating and characteristics of the associated SCPD		
Rated control circuit voltage (programmable)	U_c	24VDC, 110VAC or 230VAC	50 - 60Hz \pm 5Hz	Protect with 4A UL 248 Listed fuse
Rated control supply voltage	U_s	See Rating Table, 2 Amp supply (cont.)		
Relay specification	11, 12, 24 and 33, 34, 44	AC-15, 230VAC, 1A DC-13 30VDC, 0.7A		
	53, 54	AC-15, 250VAC, 3A DC-13 24VDC, 2A		
Electronic Overload relay with manual reset	Trip Class	10, 20 or 30 (See Sizing Guide for associated I_e rating)		
	Current setting	10% I_e to I_e		
	Rated frequency	50 to 60Hz \pm 5Hz		
	Time-current characteristics	See Fig.1 for trip curves (Trip time $T_p \pm 20\%$)		
EMC Emission levels	EN 55011	Class A *		
EMC Immunity levels	IEC 61000-4-2	8kV/air discharge or 4kV/contact discharge		
	IEC 61000-4-3	10 V/m		
	IEC 61000-4-4	2kV/5kHz (main and power ports)		
		1kV/5kHz (signal ports)		
	IEC 61000-4-5	2kV line-to-ground / 1kV line-to-line		
IEC 61000-4-6	10V			
Transient surge suppression shall be installed on the line side of this equipment and shall be rated 600_V (phase to phase), suitable for overvoltage category III, and shall provide protection for a rated impulse withstand voltage peak of 6 kV" – or equivalent.				
* NOTICE: This product has been designed for environment A. Use of this product in environment B may cause unwanted electromagnetic disturbances, in which case the user may be required to take adequate mitigation measures				

Installation

4.3 Sizing Guide

4.3.1 In-Line Connection

Size 1 and 2

I _e A	kW			FLA A	Hp					Trip Class 10 I _e : AC-53a: 3.5-17: 90-5 VMX-	Trip Class 20 I _e : AC-53a: 4-19: 90-5 VMX-	Trip Class 30 I _e : AC-53a: 4-29: 90-5 VMX-
	230V	400V	500V		200V	208V	220-240V	440-480V	550-600V			
17	4	7.5	7.5	17	3	5	5	10	15	SGY-I-17	SGY-I-22	SGY-I-29
22	5.5	11	11	22	5	5	5	15	20	SGY-I-22	SGY-I-29	SGY-I-35
29	7.5	15	15	27	7.5	7.5	7.5	20	25	SGY-I-29	SGY-I-35	SGY-I-41
35	7.5	18.5	22	34	10	10	10	25	30	SGY-I-35	SGY-I-41	SGY-I-55
41	11	22	22	41	10	10	10	30	40	SGY-I-41	SGY-I-55	SGY-I-66
55	15	30	37	52	15	15	15	40	50	SGY-I-55	SGY-I-66	SGY-I-80
66	18.5	37	45	65	20	20	20	50	60	SGY-I-66	SGY-I-80	SGY-I-100
80	22	45	55	77	20	25	25	60	75	SGY-I-80	SGY-I-100	SGY-I-132
100	30	55	55	99	30	30	30	75	100	SGY-I-100	SGY-I-132	SGY-I-160
132	37	75	90	125	40	40	40	100	125	SGY-I-132	SGY-I-160	SGY-I-195
160	45	90	110	156	50	50	60	125	150	SGY-I-160	SGY-I-195	See Size 3
195	55	110	132	192	60	60	75	150	200	SGY-I-195	See Size 3	See Size 3

Size 3

I _e A	kW			FLA A	Hp					Trip Class 10 I _e : AC-53a: 3.5-17: 90-3 VMX-	Trip Class 20 I _e : AC-53a: 4-19: 90-3 VMX-	Trip Class 30 I _e : AC-53a: 4-29: 90-3 VMX-
	230V	400V	500V		200V	208V	220-240V	440-480V	550-600V			
160	45	90	110	156	50	50	60	125	150	See Size 2	See Size 2	SGY-I-242
195	55	110	132	192	60	60	75	150	200	See Size 2	SGY-I-242	SGY-I-302
242	75	132	160	242	75	75	75	200	250	SGY-I-242	SGY-I-302	SGY-I-361
302	90	160	200	302	100	100	100	250	300	SGY-I-302	SGY-I-361	SGY-I-430
361	110	200	250	361	125	125	150	300	350	SGY-I-361	SGY-I-430	SGY-I-500
430	132	250	250	414	150	150	150	350	450	SGY-I-430	SGY-I-500	-
500	150	280	355	480	150	150	200	400	500	SGY-I-500	-	-

Installation

Sizing Guide (continued)

4.3.2 In-Delta Connection

Size 1 and 2

I _e ¹⁾	kW			FLA ¹⁾	Hp					Trip Class 10 I _e : AC-53a: 3.5-17: 90-5 VMX-	Trip Class 20 I _e : AC-53a: 4-19: 90-5 VMX-	Trip Class 30 I _e : AC-53a: 4-29: 90-5 VMX-
	A	230 V	400 V		500 V	A	200 V	208 V	220-240V			
29	7.5	15	18.5	29	7.5	7.5	10	20	25	SGY-I-17	SGY-I-22	SGY-I-29
38	11	18.5	22	36	10	10	10	25	30	SGY-I-22	SGY-I-29	SGY-I-35
50	11	22	30	47	10	15	15	30	40	SGY-I-29	SGY-I-35	SGY-I-41
61	18.5	30	37	59	15	15	20	40	50	SGY-I-35	SGY-I-41	SGY-I-55
71	18.5	37	45	69	20	20	25	50	60	SGY-I-41	SGY-I-55	SGY-I-66
95	22	45	55	90	25	30	30	60	75	SGY-I-55	SGY-I-66	SGY-I-80
114	30	55	75	113	30	30	40	75	100	SGY-I-66	SGY-I-80	SGY-I-100
139	37	75	90	133	40	40	50	100	125	SGY-I-80	SGY-I-100	SGY-I-132
173	55	90	110	166	50	50	60	125	150	SGY-I-100	SGY-I-132	SGY-I-160
229	55	110	160	215	60	75	75	150	200	SGY-I-132	SGY-I-160	SGY-I-195
277	75	150	185	270	75	75	100	200	250	SGY-I-160	SGY-I-195	See Size 3
338	90	185	220	312	100	100	125	250	300	SGY-I-195	See Size 3	See Size 3

Size 3

I _e ¹⁾	kW			FLA ¹⁾	Hp					Trip Class 10 I _e : AC-53a: 3.5-17: 90-3 VMX-	Trip Class 20 I _e : AC-53a: 4-19: 90-3 VMX-	Trip Class 30 I _e : AC-53a: 4-29: 90-3 VMX-
	A	230V	400V		500V	A	200V	208V	220-240V			
277	75	150	185	270	75	75	100	200	250	See Size 2	See Size 2	SGY-I-242
338	90	185	220	312	100	100	125	250	300	See Size 2	SGY-I-242	SGY-I-302
419	132	220	300	419	150	150	150	350	450	SGY-I-242	SGY-I-302	SGY-I-361
523	160	300	375	523	150	150	200	450	500	SGY-I-302	SGY-I-361	SGY-I-430
625	200	355	425	625	200	200	250	500	600	SGY-I-361	SGY-I-430	SGY-I-500
745	220	425	530	717	250	250	250	500	700	SGY-I-430	SGY-I-500	-
866	280	500	630	831	250	300	300	600	800	SGY-I-500	-	-

¹⁾ Maximum motor line current indicated. For In-Delta connections, all six motor wires must be available for connection, and it is critical to exactly follow the In-Delta wiring diagram in the VMX-Synergy Plus™ User Manual. The Soft Starter will only sense the Phase Current, which is about 57.7% of the motor line current.

Installation

4.4 Short Circuit Protection

4.4.1 Size 1

Type designation (eg. VMX-SGY-I-...)			17	22	29	35	41	55	66	80	100
Rated operational currents	I_e	A	17	22	29	35	41	55	66	80	100
Rated conditional short circuit current	I_q	kA	10	10	10	10	10	10	10	10	10
Class J time-delay fuse #1	Maximum rating Z_1	A	25	30	40	45	60	70	90	100	125
UL Listed inverse-time delay circuit breaker #1	Maximum rating Z_2	A	-	-	-	-	-	-	-	-	-
Semiconductor fuse (class aR) #2	Type		Mersen 6,9 URD 30 __ Bussmann 170M30 __ Bussmann 170M31 __ Bussmann 170M32 __ SIBA 20 61 __				Mersen 6,9 URD 31 __ Bussmann 170M40 __ Bussmann 170M41 __ Bussmann 170M42 __ SIBA 20 61 __				
	Fuse rating	A	100	100	160	160	200	200	200	315	315

4.4.2 Size 2 and 3

Type designation (eg. VMX-SGY-I-...)			132	160	195	242	302	361	430	500
Rated operational currents	I_e	A	132	160	195	242	302	361	430	500
Rated conditional short circuit current	I_q	kA	10	10	10	18	18	18	30	30
Class J time-delay fuse #1	Maximum rating Z_1	A	175	200	250	350	400	450	600	600
UL Listed inverse-time delay circuit breaker #1	Maximum rating Z_2	A	-	-	-	400	500	600	700	800
Semiconductor fuse (class aR) #2	Type		Mersen 6,9 URD 31 __ Bussmann 170M40 __ Bussmann 170M41 __ Bussmann 170M42 __ SIBA 20 61 __			Mersen 6,9 URD 33 __ Bussmann 170M60 __ Bussmann 170M61 __ Bussmann 170M62 __ SIBA 20 63 __				
	Fuse rating	A	400	550	550	900	900	900	1000	1000

- # 1. Suitable For Use On A Circuit Capable Of Delivering Not More Than I_q rms Symmetrical Amperes, 600 Volts Maximum, When Protected by Class J time delay Fuses with a Maximum Rating of Z_1 or by a Circuit Breaker with a Maximum Rating of Z_2 .
- # 2. Correctly selected semiconductor fuses can provide additional protection against damage to the VMX-Synergy Plus™ unit (This is sometimes referred to as type 2 co-ordination). These semiconductor fuses are recommended to provide this increased protection.

Installation

4.5 Electronic Overload Relay

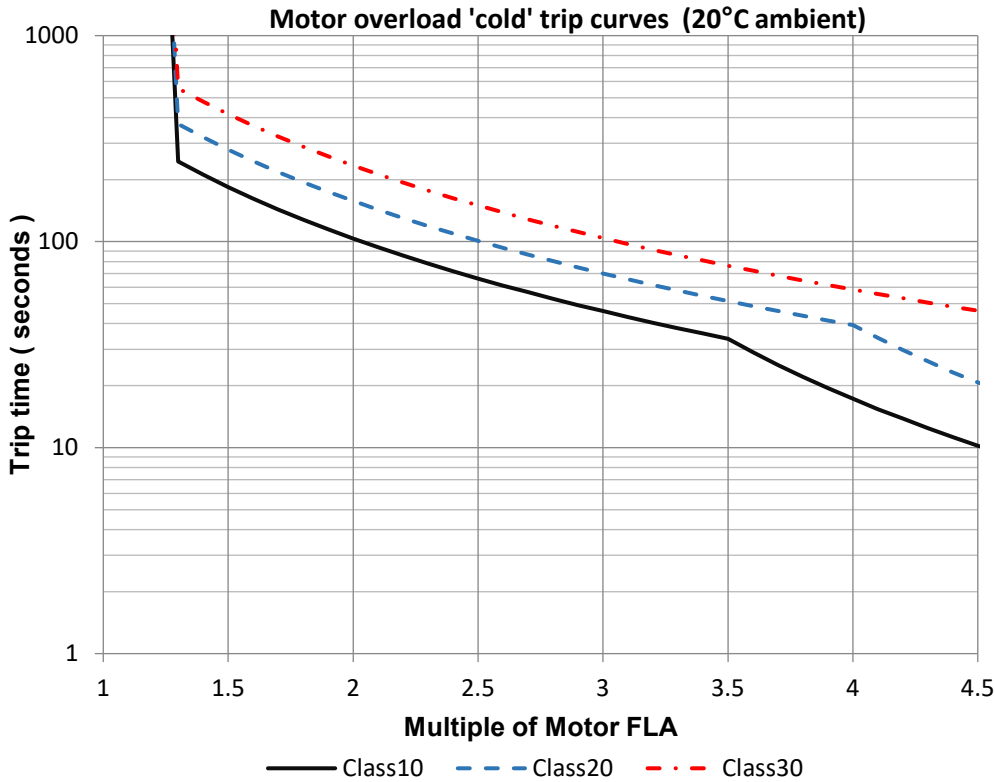



Fig 1: Trip curves

Note: When the overload has tripped, there is a forced cooling time to allow the overload to recover before the next start. The 'warm' trip times are 50% of the 'cold' trip time.

4.6 Conductor Size and Torque Requirements

Terminal		Models	Conductor Size		Torque	
			Metric	Imperial	Nm	lb-in
Main Terminals Cu STR 75°C only	Terminal	VMX-SGY-I-17 to VMX-SGY-I-100	2.5 - 70mm ²	12- 2/0AWG	9	80
		VMX-SGY-I-132 to VMX-SGY-I-195	4 - 185mm ²	12 - 350MCM	14	124
	M10 bolt	VMX-SGY-I-242 to VMX-SGY-I-361	2 x 95mm ²	2 x 4/0AWG	28	248
		VMX-SGY-I-430 to VMX-SGY-I-500	2 x 150mm ²	2 x 350MCM		
Control terminals		All models	0.2-1.5mm ²	24-16AWG	0.5	4.5
Protective Earth ¹⁾ Cu only 	M6 stud	VMX-SGY-I-17 to VMX-SGY-I-41	≥ 6mm ²	≥ 10AWG	8	71
		VMX-SGY-I-55 to VMX-SGY-I-80	≥ 10mm ²	≥ 8AWG		
		VMX-SGY-I-100	≥ 16mm ²	≥ 6AWG		
	M8 stud	VMX-SGY-I-132 to VMX-SGY-I-160	≥ 16mm ²	≥ 6AWG	12	106
		VMX-SGY-I-195	≥ 25mm ²	≥ 4AWG		
		VMX-SGY-I-242	≥ 35mm ²	≥ 3AWG		
		VMX-SGY-I-302	≥ 35mm ²	≥ 2AWG		
		VMX-SGY-I-361	≥ 50mm ²	≥ 1AWG		
VMX-SGY-I-430 to VMX-SGY-I-500	≥ 70mm ²	≥ 1/0AWG				

¹⁾ Protective Earth wire size based on bonding conductor requirements of UL508 Table 7.4 and UL508A Table 15.1, with suitable equivalent metric conductor sizes as per IEC 60947-1 Table 7a.

²⁾ The actual conductor used must comply with local wiring regulations.

Installation

4.7 Model Number Description

VMX-SGY-I-17-6-XX-XX

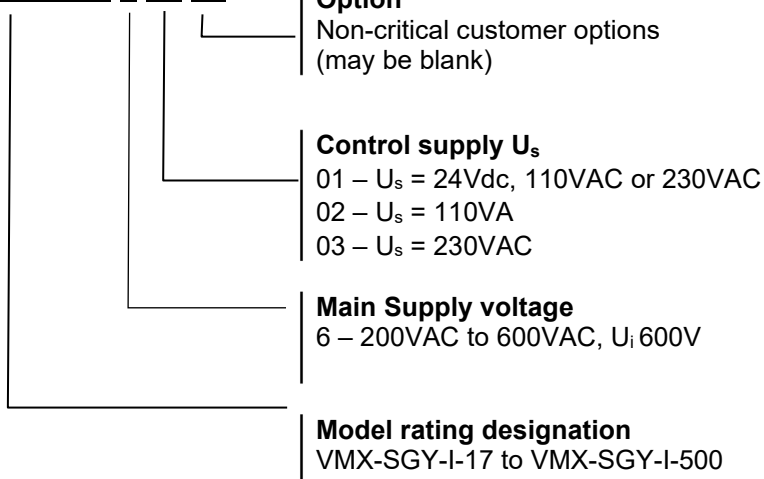

4.8 Temperature and Altitude De-rate



-20°C (-4°F) to 50°C (122°F). Above 50°C (122°F) de-rate linearly by 4 % of VMX-Synergy Plus™ I_e per °C to a maximum of 60°C (140°F).



Altitude above sea level 1000m (3281ft). Above 1000m (3281ft) de rate by 1% of VMX-Synergy Plus™ I_e per 100m (328ft) to a maximum altitude of 2000m (6562ft).

Please note for higher temperatures and altitudes, contact your supplier.

5. Operation

5.1 Configuration and Parameters

5.1.1 Features

Status LED

The LED on the VMX-Synergy Plus™ front panel will blink once every 10 seconds to provide visual confirmation that all microprocessors in the soft starter are operating properly.

Configuration Overview

Configuring VMX-Synergy Plus™ soft starters is as simple as setting the parameters to match your motor, application, power source, control scheme, etc.

VMX- Synergy Plus™ may be configured from its touchscreen, from an optional remote touchscreen, or from a PLC using Modbus RTU via the onboard RJ45 connector.

Auto Setup Procedure

Allows the user to change all the parameters at once to settings that are typical for general applications. One or more parameters as can be adjusted to fine tune the settings for your specific application.

Setup by Individual Parameter Settings

Allows the user to change the parameter settings one at a time. The individual parameters are grouped by categories as on the touchscreen.

Configuration from Touchscreen

Use the on-screen buttons to enter data or to scroll through setup menus, using the “UP,” DOWN,” “BACK,” and “NEXT” buttons as necessary. From the home “Menu” screen, select either “Auto Setup” or “Advanced.”

Auto Setup

On initial power up, VMX-Synergy Plus™ will show a ‘Setup Wizard’ menu – Auto and Advanced. To jump immediately to the pre-defined parameter sets, press the Auto button and follow the on-screen prompts. Refer to the example on the following screen.

To automatically set up parameters on subsequent start-up, select the ‘Home’ menu from the status screen and select ‘Auto Setup’. Follow the on-screen prompts. Refer to the example on the following screen.

Individual Parameter Setup

From the Setup Wizard or ‘Home’ menu, select the ‘Advanced’ menu. Set the required parameters from the displayed menus. See Section 3 for detailed descriptions of the available parameters.

Operation

5.2 On Screen Menus

Initial Screen



Displayed on **FIRST** switch-on **ONLY**.

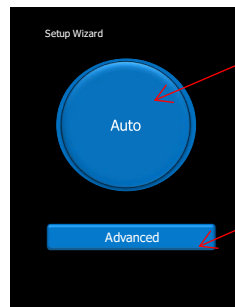

Auto Setup wizard.

Advanced menu

Status Screen

Supply Status
Turns **RED** if unit has tripped on supply failure

Motor Overload Status
Turns **RED** if unit has tripped on overload

Status Messages

Motor Side Status
Turns **RED** if unit has tripped on motor side phase loss

Returns to previous screen/menu

Enters Sub-Menus

Temperature Status
Turns **RED** if unit has tripped on over temperature

Cooling Fan Status
Turns **RED** if unit has tripped on fan failure

Internal Bypass Status (open/closed)

Displays Overload Percentage, Instantaneous running Current and Power

Start/Stop Motor
Only active if Local Control Enabled

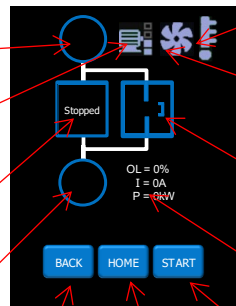

Home Screen

Auto-Setup Menu

Input/Output Menu

Logging Menu

Advanced Menus

Monitor Screens

Device Menus

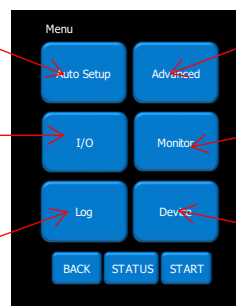

See 'Status Screen'

Operation

5.3 Auto Setup Example

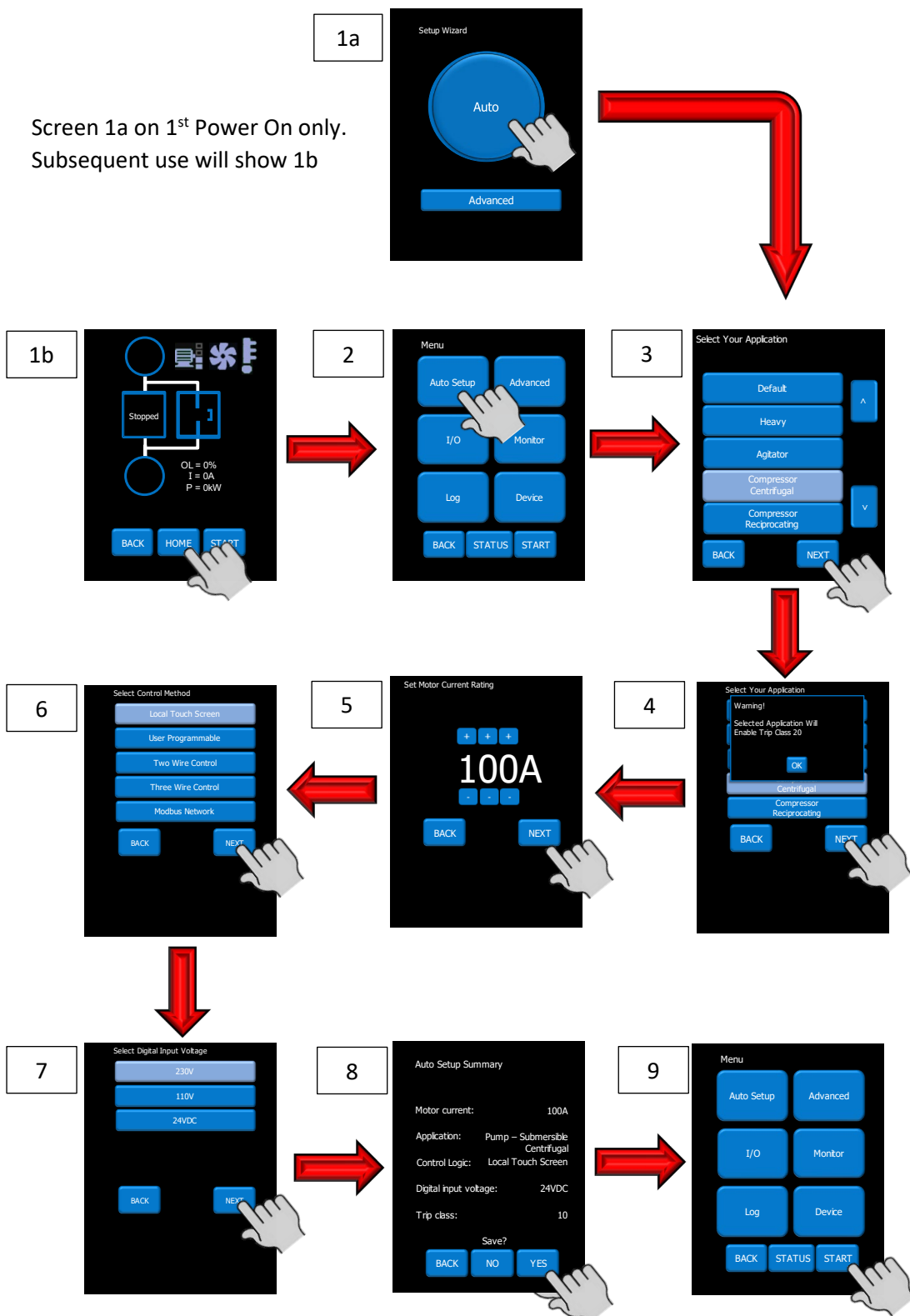

Operation

5.4 Auto-Setup Parameter Settings

#	Application	Start pedestal	Stop pedestal	Start time	Soft stop time	Trip Class	Current limit level	Current limit time	Optimize rate	Auto pedestal	Auto End Start 2	Auto End Start 1	Auto End 3	Delta Operation	Auto stop	Soft stop smoothing	spare	Auto ramp	Auto end stop	Auto Impact load	Current limit - stopping	Current limit time
-	Unit	%	%	s	s	-	FLC	s	-	En	En	En	En	En	En	En	En	En	En	En	FLC	s
0	Default	20	10	10	0	10	3.5	30	5	0	0	0	1	1	0	0	0	0	0	0	8	2
1	Heavy	40	10	10	0	20	4	40	5	1	0	1	1	1	0	0	0	0	0	0	8	2
2	Agitator	30	10	10	0	10	3.5	25	5	1	0	1	1	1	0	0	0	0	0	0	8	2
3	Compressor - Centrifugal	35	10	15	0	20	3.5	25	5	1	0	1	1	1	0	0	0	0	0	0	8	2
4	Compressor - Reciprocating	45	10	15	0	20	3.5	25	15	1	0	1	1	1	0	0	0	0	0	0	8	2
5	Compressor - Screw	40	10	15	0	20	3.5	25	5	1	0	1	1	1	0	0	0	0	0	0	8	2
6	Compressor - Vane	35	10	7	0	10	3.5	25	5	1	0	1	0	1	0	0	0	0	0	0	8	2
7	Compressor - Scroll	35	10	7	0	10	3.5	25	15	1	0	1	0	1	0	0	0	0	0	0	8	2
8	Ball Mill	40	10	10	0	20	5.5	25	5	1	0	1	0	1	0	0	0	0	0	0	8	2
9	Centrifuge	40	10	10	0	30	2.5	300	5	1	0	1	0	1	0	0	0	0	0	0	8	2
10	Bow Thruster - Zero Pitch	10	10	10	0	10	2.5	25	5	1	1	0	1	1	0	0	0	0	0	0	8	2
11	Bow Thruster - Loaded	10	10	10	0	20	4	25	5	1	1	0	1	1	0	0	1	0	0	0	8	2
12	Conveyor - Unloaded	10	10	10	7	10	3.5	30	5	1	0	1	0	1	1	1	1	0	1	0	2	10
13	Conveyor - Loaded	10	10	10	7	20	5.5	30	5	1	0	1	0	1	1	1	0	0	1	0	2	10
14	Crusher	40	10	10	0	30	3.5	60	5	1	0	1	0	1	0	0	0	0	0	0	8	2
15	Fan - Low Inertia	30	10	15	0	10	3.5	30	5	1	0	1	0	1	0	1	0	0	0	0	8	2
16	Fan - High Inertia	40	10	10	0	30	3.5	60	5	1	0	1	0	1	0	0	0	0	0	0	8	2
17	Feeder - screw	20	10	10	0	10	3.5	25	5	1	0	1	0	1	0	0	0	0	0	0	8	2
18	Grinder	40	10	10	0	20	3.5	40	5	1	0	1	0	1	0	0	0	0	0	0	8	2
19	Hammer Mill	40	10	10	0	20	3.5	40	5	1	0	1	0	1	0	0	0	0	0	0	8	2
20	Lathe Machines	10	10	15	0	10	3.5	25	5	1	0	1	0	1	0	0	0	0	0	0	8	2
21	Mills - flour etc	40	10	10	0	20	3.5	40	5	1	0	1	0	1	0	0	0	0	0	0	8	2
22	Mixer - Unloaded	10	10	10	0	10	3.5	25	5	1	0	1	0	1	0	0	0	0	0	0	8	2
23	Mixer - Loaded	10	10	10	0	20	4	25	5	1	0	1	0	1	0	0	0	0	0	0	8	2
24	Moulding Machine	10	10	10	0	10	4.5	25	5	1	0	1	0	1	0	0	0	0	0	1	8	2
25	Pelletisers	40	10	10	0	20	5.5	25	5	1	0	1	0	1	0	0	0	0	0	0	8	2
26	Plastic and Textile Machines	10	10	10	0	10	4.5	25	5	1	0	1	0	1	0	0	1	0	0	1	8	2
27	Press, Flywheel	40	10	10	0	20	3.5	40	5	1	0	1	0	1	0	0	1	0	0	1	8	2
28	Pump - Submersible Centrifugal	10	10	10	60	10	3.5	25	5	1	0	0	0	1	1	1	1	0	1	0	2	25
29	Pump - Submersible Rotodynamic	10	10	10	60	10	3.5	25	5	1	0	0	0	1	1	1	1	0	1	0	2	25
30	Pump - Positive Displacement Reciprocating	10	10	10	60	20	3.5	25	15	1	0	0	0	1	1	1	0	0	1	0	2	25
31	Pump - Positive displacement Rotary	10	10	10	60	20	3.5	25	15	1	0	0	0	1	1	1	0	0	1	0	2	25

(continued overleaf)

Operation

Auto-Setup Parameter Setting (continued)

#	Application	Start pedestal		Stop pedestal		Start time		Soft stop time		Trip Class	Current limit level	Current limit time	Optimize rate	Auto pedestal	Auto End Start 2	Auto End Start 1	Auto End 3	Delta Operation	Auto stop	Soft stop smoothing	spare	Auto ramp	Auto end stop	Impact load	Current limit - stopping	Current limit time	
		%	%	s	s	-	FLC	s	-	En	En	En	En	En	En	En	En	En	En	En	En	En	En	En	FLC	s	
32	Pump Jack	40	10	10	0	2	3.5	40	5	1	0	1	0	1	0	1	0	0	0	0	0	0	0	0	1	8	2
33	Rolling Mill	40	10	10	0	2	3.5	40	5	1	0	1	0	1	0	1	0	0	0	0	0	0	0	0	0	8	2
34	Roots Blower	30	10	10	0	2	4.5	25	5	1	0	1	0	1	0	1	0	0	0	0	0	0	0	0	0	8	2
35	Saw - Band	10	10	10	0	1	3.5	25	5	1	0	1	0	1	0	1	0	0	0	0	0	0	0	0	0	8	2
36	Saw - Circular	40	10	10	0	2	3.5	40	5	1	0	1	0	1	0	1	0	0	0	0	0	0	0	0	0	8	2
37	Screen - Vibrating	40	10	10	0	2	4.5	40	5	1	0	1	0	1	0	1	0	0	0	0	0	0	0	0	0	8	2
38	Shredder	40	10	10	0	3	3.5	60	5	1	0	1	0	1	0	1	0	0	0	0	0	0	0	0	0	8	2
39	Transformers, Voltage Regulators	10	10	5	0	1	3.5	25	5	0	0	0	0	0	0	0	0	1	0	0	0	0	0	0	0	8	2
40	Tumblers	20	10	10	0	2	4	25	5	1	0	1	0	1	0	0	0	0	0	0	0	0	0	0	0	8	2
41	Wood Chipper	40	10	10	0	3	3.5	60	5	1	0	1	0	1	0	0	0	0	0	0	0	0	0	0	0	8	2

Operation

5.5 Auto Reset Function

The Auto Reset feature automatically resets a selected number of faults and then attempts a start without user intervention. The time between the resets and the number of reset attempts are both programmable. If the Auto Reset has been successful, the Starter must operate trip free for a set time before the counters are re-initialised. If the number of attempts exceeds the set value, the Auto Reset terminates, and the counters will be re-initialised when a Reset or Stop signal is given by the user.



WARNING:
When Auto Reset is enabled, a tripped motor may restart automatically after the Reset Delay time. This may result in equipment damage or personal injury if the function is used in an unsuitable application. Do not use this function without considering applicable local, national, and international standards, regulations, or industry guidelines.

The Auto-Reset function is accessible from the Advanced Menu (see Auto-Reset section of parameter summaries):

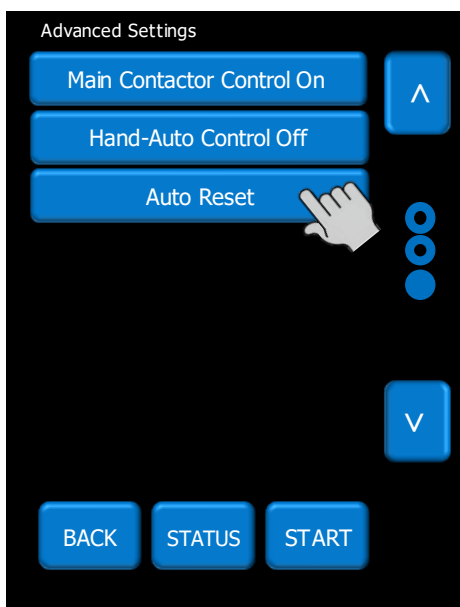

Operation

Auto Reset Function (continued)

The screenshot shows the 'Auto Reset' menu with the following options and callouts:

- Auto Reset Off**: Toggles the Auto-Reset function Off/On.
- Reset Delay 0s**: Delay between trip and Auto-Reset.
- Reset Attempts 0**: Number of permissible Auto-Reset attempts.
- Trip Free Time 600s**: The time the unit must be trip free before the counter is set to zero.
- Reset Trips**: Enters Auto-Rest trip selection menu (see below).

At the bottom of the menu are three buttons: BACK, STATUS, and START.

Example page of Reset Trips Sub Menu

The screenshot shows the 'Reset Trips' sub-menu with the following options:

- Input Side Phase Loss On
- Motor Side Phase Loss On
- Overload On
- Thyristor Firing On
- Sensing Fault On

Navigation is controlled by an up arrow (^) and a down arrow (v) on the right side of the menu. A callout indicates: "Scroll through Auto-Reset Trips".

At the bottom of the menu are three buttons: BACK, STATUS, and START.

Operation

Auto Reset Function (continued)

 The status of the Auto-Reset function may be observed in the 'Monitor' menu

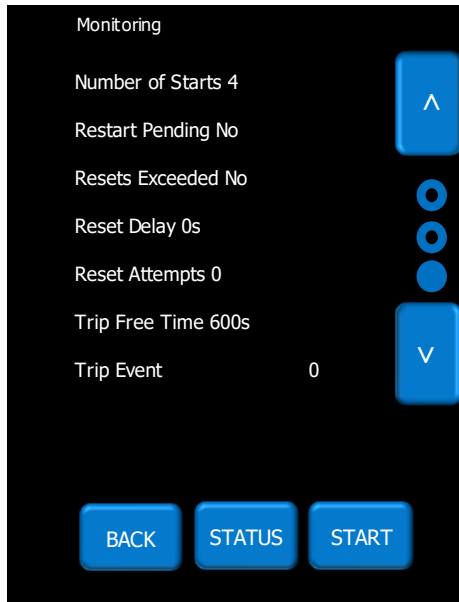

5.5.1 Mapping Auto Reset Status to Digital Outputs

Auto Reset Pending and Auto Reset Exceeded may be mapped to the Digital Outputs (D1 – D5). The selection screen is located in the I/O Menu:

I/O – DIGITAL OUTPUTS – DIGITAL OUTPUT (1 to 5) – SELECT FUNCTION

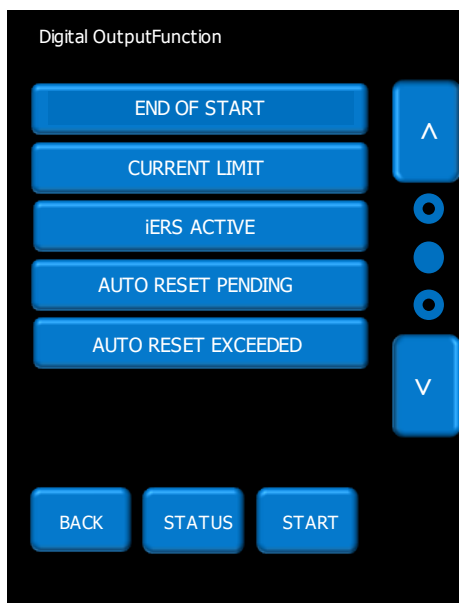

Operation

Auto Reset Function (continued)

5.5.2 Two-Wire, Three-Wire and Communications Control

The Auto Reset operates with Two-Wire, Three-Wire and communications start/stop. Generally, this is not a problem if the control supply is maintained, although warning should be given that in Three-Wire and communications control the motor may start without a direct start signal. (Although it is implied as no stop had been given during the reset delay period).

5.5.3 Control Supply Loss

When the control supply is removed the microcontroller is unable to make calculations in real time. To overcome this the calculations are made retrospectively when the starter powers up.

Two Wire: Following a control supply loss the Start signal must be retained (Fig 5.6.2).

Three Wire: The state of the start signal is saved when the control supply is removed and if it was set to 'start' the Auto Reset will continue at power up. When operating in this mode the motor may start at power up without a start signal being present (Fig 5.6.3).

5.5.4 Modbus/Communications

The state of the start signal is saved when the control supply is removed and if it was set to 'start' the Auto Reset will continue at power up. When operating in this mode the motor may start at power up without a start signal being present (Fig 5.6.3).

Auto Restart Termination: If the time to re-establish the power exceeds the Reset Delay x Reset Attempts the Auto Reset terminates.

5.5.5 Overload Trip

Following an overload trip, the overload will at 100% and then cool exponentially to 0% after several minutes.

If a restart is attempted too soon the starter will trip again as the overload would not have cooled to a sufficient level (Fig 5.6.5).

It must be ensured the Reset Delay is long enough to allow the overload to cool. This is also the case for the heatsink over temperature trip.

5.5.6 Remote Start on Trip

If Auto Reset is turned on the Remote Start On trip trips are disabled and will be ignored.

5.5.7 Hand/Auto

If the Hand Auto option is selected the Hand Selection will override the Auto Reset.

The Auto Reset will be terminated, and the counters will be re-initialised.

Operation

5.6 Auto Reset Timing Diagrams

Fig 5.6.1: Auto Reset - Two Wire -Three Phase Supply Loss

The timing diagrams show the auto reset with a maintained two wire control system
 The fault shown is a 3-phase supply loss only, the Control Supply maintained
 The 3-Phase power is re-established (after the 2nd attempt) before the Reset Attempts counter is depleted
 This assumes the start signal is maintained, if it is removed the Auto Reset terminates
 Once power has been re-established there are no further outages and the counters are reset after the trip free time.

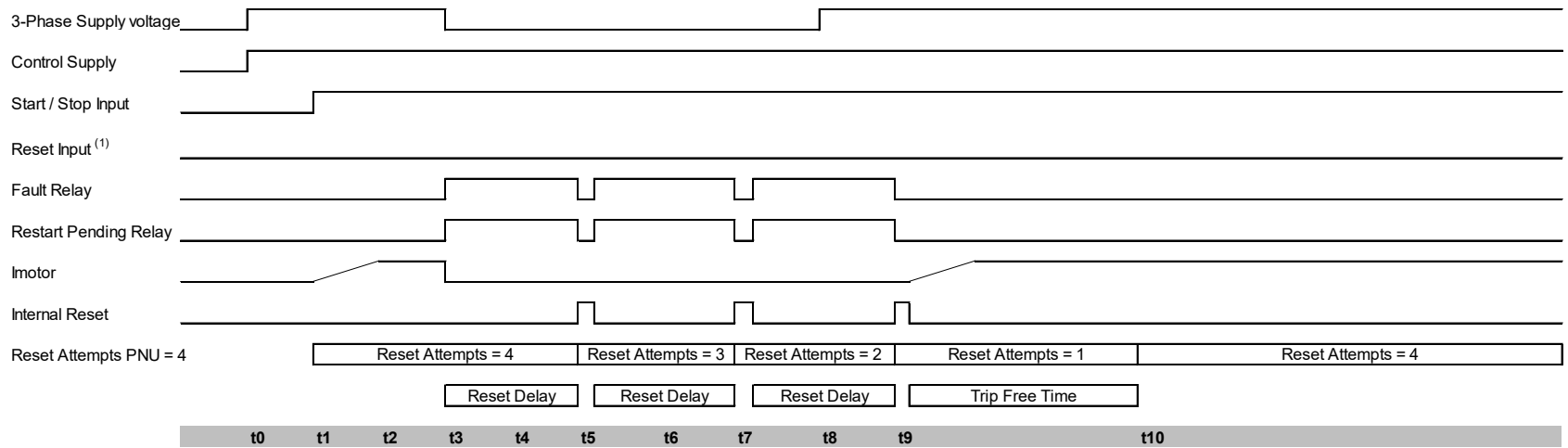

Sequence of events	
t0	3 phase supply applied
t1	Start signal applied, motor starts
t2	Motor reaches full voltage
t3	3 phase supply removed
t4	Start signal must still be applied If it has been removed Auto Reset feature re-initialises
t5	Reset delay = 0 Restart Attempt = 3
t6	Reset Signal must be low If the trip is reset the Auto Reset feature re-initialises
t7	Reset delay = 0 Restart Attempt = 2
t8	3-Phase re-established
t9	Reset delay = 0 Restart Attempt = 1
t10	Trip Free Delay = 0 Restart Attempt = 4

User Parameters (R/W)		
PNU	Range	Default
Auto Reset	Off / On	Off
Reset Delay	0-7200s	0s
Reset Attempts	0-10	0
Reset Trips	All resettable trips	-
Trip Free Time	0-7200s	600s

Monitor Parameters (R/O)	
PNU	Range
Auto Reset Pending	0-1
Auto Reset Exceeded	0-1
Auto Reset Delay Remaining	0-7200s
Auto Reset Attempts Remaining	0-10
Auto Reset Trip Free Time Remaining	0-7200s

Notes
 For Two Wire control reset occurs automatically when the start signal changes state from low to high, reset shown is programmable reset input ⁽¹⁾

Operation

Auto Reset Timing Diagrams (continued)

Fig 5.6.2 Auto Reset - Two Wire - Control Supply Loss

The timing diagrams show the auto reset with a maintained two wire control system
 The fault shown is a 3-phase supply loss **and** Control supply loss
 The 3-Phase power and control supply are re-established (after the 2nd attempt) before the Reset Attempts counter is depleted
 This assumes the start signal is maintained, if it is removed the Auto Reset terminates
 Once power has been re-established there are no further outages and the counters are reset after the trip free time.

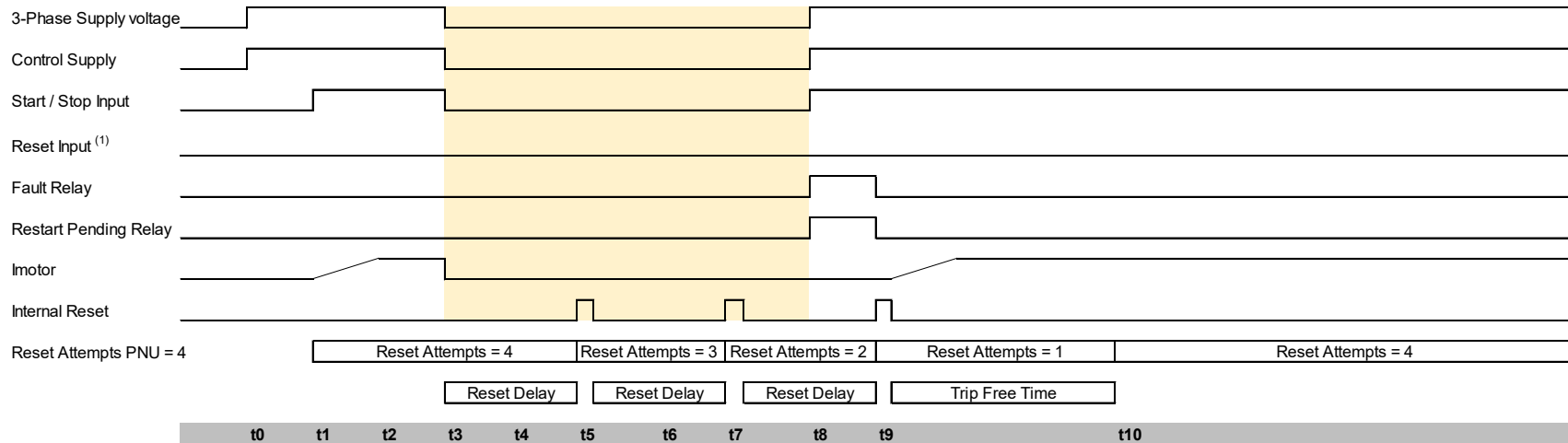

Sequence of events	
t0	3 phase supply applied
t1	Start signal applied, motor starts
t2	Motor reaches full voltage
t3	3 phase supply removed
t5	Reset delay = 0 Restart Attempt = 3
t7	Reset delay = 0 Restart Attempt = 2
t8	3-Phase re-established Start signal must still be applied If it has been removed Auto Reset feature re-initialises If the trip is reset the Auto Reset feature re-initialises
t9	Reset delay = 0 Restart Attempt = 1
t10	Trip Free Delay = 0 Restart Attempt = 4

User Parameters (R/W)		
PNU	Range	Default
Auto Reset	Off / On	Off
Reset Delay	0-7200s	0s
Reset Attempts	0-10	0
Reset Trips	All resettable trips	-
Trip Free Time	0-7200s	600s

Monitor Parameters (R/O)	
PNU	Range
Auto Reset Pending	0-1
Auto Reset Exceeded	0-1
Auto Reset Delay Remaining	0-7200s
Auto Reset Attempts Remaining	0-10
Auto Reset Trip Free Time Remaining	0-7200s

Notes
 The Starter is powered down between t3 and t8 (yellow shaded region)
 During this time controller is unable to make the calculations in real time
 To overcome this the calculations are made retrospectively at time t8
 The Start Signal must be maintained, if it is not the Auto Restart will be terminated
 For Two Wire control reset occurs automatically when the start signal changes state from low to high, reset shown is programmable reset input⁽¹⁾
 If the time to re-establish the power exceeds (Reset Delay x Reset Attempts) to Auto Reset terminates

Operation

Auto Reset Timing Diagrams (continued)

Fig 5.6.3 Auto Reset - Three Wire - Three Phase Supply Loss

The timing diagrams show the auto reset with Three wire / Modbus control
 The fault shown is a 3-phase supply loss only, the Control Supply maintained
 The 3-Phase power is re-established (after the 2nd attempt) before the Reset Attempts counter is depleted
 This assumes the momentary stop signal is not activated, if it is the Auto Reset terminates
 Once power has been re-established there are no further outages and the counters are reset after the trip free time.

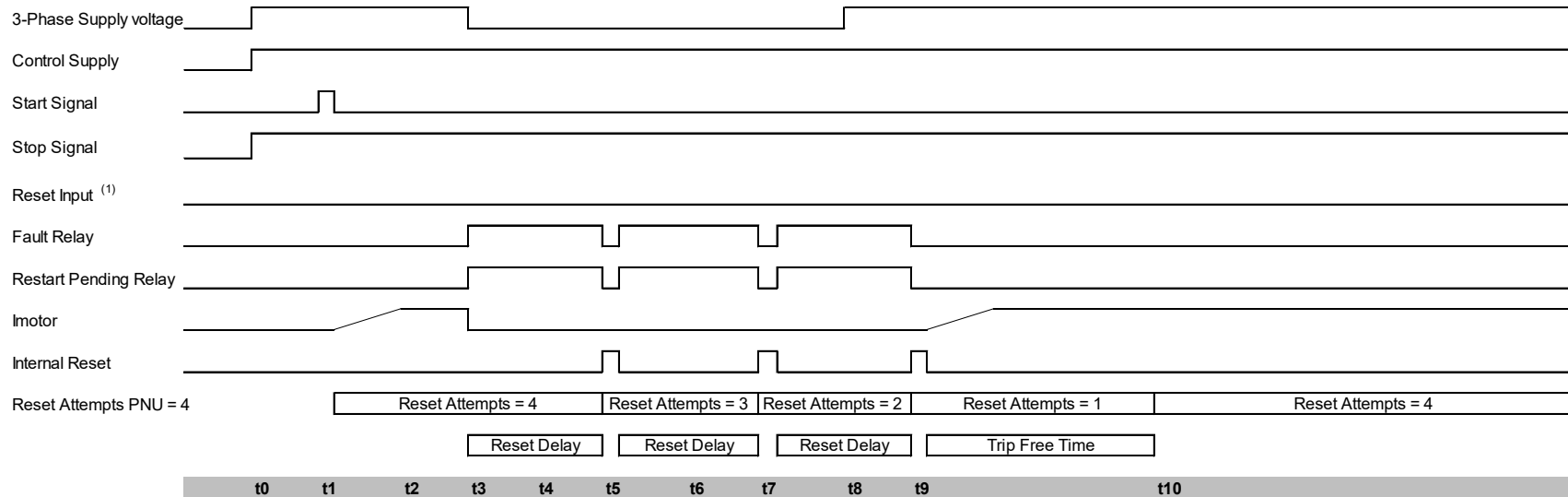

Sequence of events	
t0	3 phase supply applied
t1	Start signal applied, motor starts
t2	Motor reaches full voltage
t3	3 phase supply removed
t4	Start signal must still be applied If it has been removed Auto Reset feature re-initialises
t5	Reset delay = 0 Restart Attempt =3
t6	Reset Signal must be low If the trip is reset the Auto Reset feature re-initialises
t7	Reset delay = 0 Restart Attempt =2
t8	3-Phase re-established
t9	Reset delay = 0 Restart Attempts =1
t10	Trip Free Delay = 0 Restart Attempts =4

User Parameters (R/W)		
PNU	Range	Default
Auto Reset	Off / On	Off
Reset Delay	0-7200s	0s
Reset Attempts	0-10	0
Reset Trips	All resettable trips	-
Trip Free Time	0-7200s	600s

Monitor Parameters (R/O)	
PNU	Range
Auto Reset Pending	0-1
Auto Reset Exceeded	0-1
Auto Reset Delay Remaining	0-7200s
Auto Reset Attempts Remaining	0-10
Auto Reset Trip Free Time Remaining	0-7200s

Notes
 (1) Separate reset signal not available on all products

Operation

Auto Reset Timing Diagrams (continued)

Fig 5.6.4 Auto Reset - Three Wire - Control Supply Loss

The timing diagrams show the auto reset with Three wire / Modbus control
 The fault shown is a 3-phase supply loss **and** Control supply loss
 The 3-Phase power and control supply are re-established (after the 2nd attempt) before the Reset Attempts counter is depleted
 This assumes the momentary stop signal is not activated, if it is the Auto Reset terminates
 Once power has been re-established there are no further outages and the counters are reset after the trip free time.

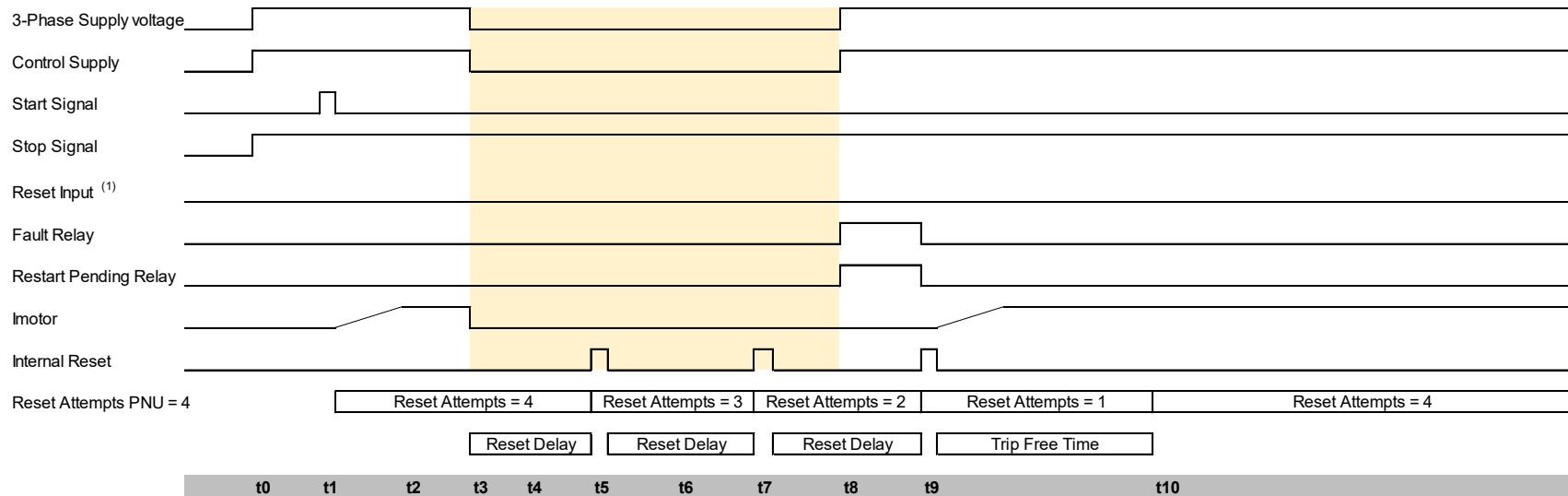

Sequence of events	
t0	3 phase supply applied
t1	Start signal applied, motor starts
t2	Motor reaches full voltage
t3	3 phase supply removed
t5	Reset delay = 0 Restart Attempts = 3
t7	Reset delay = 0 Restart Attempts = 2
t8	3-Phase re-established Start signal must still be applied If it has been removed Auto Reset feature re-initialises Rest Signal must be low If the trip is reset the Auto Reset feature re-initialises
t9	Reset delay = 0 Restart Attempts = 1
t10	Trip Free Delay = 0 Restart Attempts = 4

User Parameters (R/W)		
PNU	Range	Default
Auto Reset	Off / On	Off
Reset Delay	0-7200s	0s
Reset Attempts	0-10	0
Reset Trips	All resettable trips	-
Trip Free Time	0-7200s	600s

Monitor Parameters (R/O)	
PNU	Range
Auto Reset Pending	0-1
Auto Reset Exceeded	0-1
Auto Reset Delay Remaining	0-7200s
Auto Reset Attempts Remaining	0-10
Auto Reset Trip Free Time Remaining	0-7200s

Notes
 The controller is powered down between t3 and t8 (yellow shaded region)
 During this time controller is unable to make the calculations in real time
 To overcome this the calculations are made retrospectively at time t8
 Start signal state saved at power down and loaded at power up. **This means it will start without a start signal being present**
 If the time to re-establish the power exceeds (Reset Delay x Reset Attempts) to Auto Reset terminates
 (1) Seperate reset signal not avialbe on all products

Operation

Auto Reset Timing Diagrams (continued)

Fig 5.6.5 Auto Reset - Two Wire – Overload

The timing diagrams show the auto reset with a maintained two wire control system
 The fault shown is an overload trip, the Control Supply maintained
 In this instance the Auto Reset clears the trip but the overload (%) will take a certain amount of time to decay
 If insufficient time is left before re-starts the overload will trip again repeatably until the Reset Attempts count exceeds its set value.
 This must be considered and enough time left to allow the overload to decay to a low level

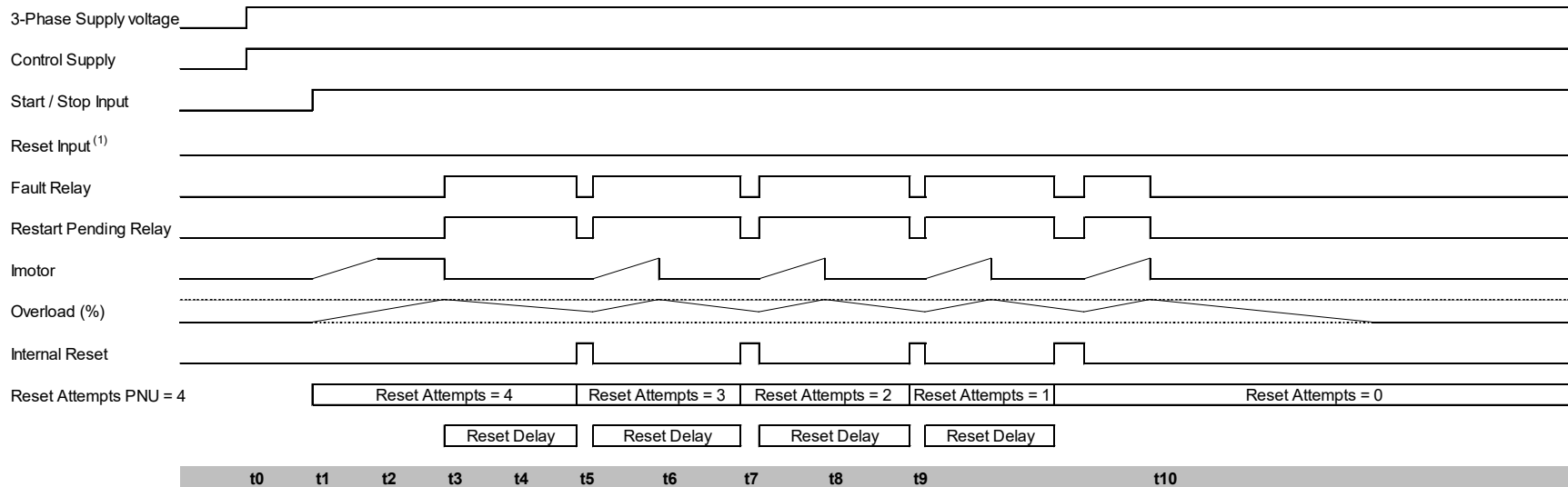

Sequence of events	
t0	3 phase supply applied
t1	Start signal applied, motor starts
t2	Motor reaches full voltage
t3	3 phase supply removed
t4	Start signal must still be applied If it has been removed Auto Reset feature re-initialises
t5	Reset delay = 0 Restart Attempts =3
t6	Rest Signal must be low If the trip is reset the Auto Reset feature re-initialises
t7	Reset delay = 0 Restart Attempts = 2
t8	3-Phase re-established
t9	Reset delay = 0 Restart Attempts = 1
t10	Trip Free Delay = 0 Restart Attempts = 0

User Parameters (R/W)		
PNU	Range	Default
Auto Reset	Off / On	Off
Reset Delay	0-7200s	0s
Reset Attempts	0-10	0
Reset Trips	All resettable trips	-
Trip Free Time	0-7200s	600s

Monitor Parameters (R/O)	
PNU	Range
Auto Reset Pending	0-1
Auto Reset Exceeded	0-1
Auto Reset Delay Remaining	0-7200s
Auto Reset Attempts Remaining	0-10
Auto Reset Trip Free Time Remaining	0-7200s

Notes
 In this instance the starter has failed to Auto Restart in the set number of attempts
 The starter will remain in the tripped state until reset
 To overcome this the Reset Delay time should be extended to allow the overload to cool
 For Two Wire control reset occurs automatically when the start signal changes state from low to high, reset shown is programmable reset input ⁽¹⁾

Operation

5.7 Parameters for Touchscreen Interface

5.7.1 'Advanced' Category

Group	Parameter	Units	Range	Read/Write	Modbus		Default Setting	User Setting
					Dec	Hex		
Save Parameters		N/A	NO/YES	R/W	62144	F2C0	NO	
Automatic Settings	Automatic Pedestal	N/A	OFF/ON	R/W	19840	4D80	OFF	
	Automatic Ramp	N/A	OFF/ON	R/W	20352	4F80	OFF	
	Automatic End Start (1)	N/A	OFF/ON	R/W	19968	4E00	OFF	
	Automatic Stop	N/A	OFF/ON	R/W	20160	4EC0	OFF	
	Automatic Stop Profile	%	0 to 100	R/W	20608	5080	50	
	Automatic End Stop	N/A	OFF/ON	R/W	20416	4FC0	OFF	
	Automatic Impact Load	N/A	OFF/ON	R/W	20480	5000	OFF	
	Auto Smooth Stop	N/A	OFF/ON	R/W	20224	4F00	OFF	
	Auto Smoothing Level	%	10 to 100	R/W	20672	50C0	50	
	Automatic End Start (2)	N/A	OFF/ON	R/W	19904	4DC0	OFF	
	– Automatic End Start (3)	N/A	OFF/ON	R/W	20032	4E40	OFF	
	– Rate End Start (3)	%	0 to 100	R/W	768	0300	75	
Start Settings	Start Time	s	1 to 300	R/W	7104	1BC0	10	
	Start Pedestal	%	10 to 100	R/W	704	02C0	20	
	Start Current Limit → Start Current Limit Trip	N/A	OFF/ON	R/W	53790	D21E	ON	
	Start Current Limit → Start Current Limit Level	A	50% motor FLA to 450% VMX-Synergy Plus™ rated A	R/W	26880	6900	350% motor FLA	
	Start Current Limit → Start Current Limit Time	s	1 to 600	R/W	26944	6940	30	
	Kick Start → Kick Start	N/A	OFF/ON	R/W	320	0140	OFF	
	Kick Start → Kick Start Time	ms	10 to 2,000	R/W	7040	1B80	100	
	Kick Start → Kick Start Pedestal	%	30 to 80	R/W	640	0280	75	
Contactor Delay	ms	20 to 60000	R/W	8320	2080	160		
Stop Settings	Stop Time	s	0 to 300	R/W	7296	1C80	0	
	Stop Pedestal	%	10 to 40	R/W	896	0380	10	
	Stop Current Limit → Stop Current Limit Trip	N/A	OFF/ON	R/W	53791	D21F	OFF	
	Stop Current Limit → Stop Current Limit Level	A	100% mtr FLA to 450% VMX-Synergy Plus™ rated A	R/W	28800	7080	350% mtr FLA	
	Stop Current Limit → Stop Current Limit Time	s	1 to 300	R/W	28864	70C0	10	

Operation

5.7.1 'Advanced' Category (continued)

Group	Parameter	Units	Range	Read/Write	Modbus		Default Setting	User Setting
					Dec	Hex		
Motor Protection	Motor Current	A	10% to 100% of VMX-Synergy Plus™ rated A	R/W	25728	6480	100%	
	Trip Class	class	10, 20, 30	R/W	25664	6440	10	
	Low Current Settings → Low Current Trip	N/A	OFF/ON	R/W	53787	D21B	OFF	
	Low Current Settings → Low Current Trip Level	A	25% to 100% of motor FLA	R/W	26304	66C0	25%	
	Low Current Settings → Low Current Trip Time	ms	100 to 9,000	R/W	26368	6700	100	
	Shearpin Settings → Shearpin Trip	N/A	OFF/ON	R/W	53793	D221	ON	
	Shearpin Settings → Shearpin Trip Current	A	100% mtr FLA to 450% VMX-Synergy Plus™ rated A	R/W	27584	6BC0	350% VMX-Synergy Plus™ A	
	Shearpin Settings → Shearpin Trip Time	ms	100 to 9,000	R/W	27648	6C00	100	
	Overload Settings → Overload Trip	N/A	OFF/ON	R/W	53792	D220	ON	
	Overload Settings → Overload Level	N/A	50% to 125% of motor FLA	R/W	28224	6E40	115%	
	Dynamic Reset	N/A	OFF/ON	R/W	448	1C0	OFF	
	Trip Class Run	N/A	OFF/ON	R/W	384	180	OFF	
	Trip Class Run Value	%	10 / 20 / 30	R/W	25668	6444	10	
iERS	iERS	N/A	OFF/ON	R/W	21120	5280	OFF	
	Dwell Time	s	1 to 300	R/W	7360	1CC0	5	
	iERS Rate	%	0 to 100	R/W	21184	52C0	25	
	iERS Level	%	0 to 100	R/W	21376	5380	100	
	Fixed Voltage	V	100 to 1000	R/W	35200	8980	400	
	Fixed Voltage	N/A	OFF/ON	R/W	35264	89C0	OFF	
Control	Control Method	–	Local Touch Screen User Programmable Two Wire Control Three Wire Control Modbus	R/W	59392	E800	Local Touch Screen	

Operation

5.7.1 'Advanced' Category (continued)

Group	Parameter	Units	Range	Read/Write	Modbus		Default Setting	User Setting
					Dec	Hex		
Trip Settings	Trip Sensitivity	%	0 to 100	R/W	44864	AF40	0	
	Keypad Trip	N/A	OFF/ON	R/W	53765	D205	ON	
	Shearpin Trip	N/A	OFF/ON	R/W	53793	D221	ON	
	Overload Trip	N/A	OFF/ON	R/W	53792	D220	ON	
	Low Current Trip	N/A	OFF/ON	R/W	53787	D21B	OFF	
	Start Current Limit Trip	N/A	OFF/ON	R/W	53790	D21E	ON	
	Stop Current Limit Trip	N/A	OFF/ON	R/W	53791	D21F	OFF	
	PTC Motor Thermistor Trip	N/A	OFF/ON	R/W	53794	D222	OFF	
	L1-L2-L3 Trip	N/A	OFF/ON	R/W	53808	D230	OFF	
	L1-L3-L2 Trip	N/A	OFF/ON	R/W	53807	D22F	OFF	
	Remote Start Trip	N/A	OFF/ON	R/W	53804	D22C	ON	
	Current Sensor Trip	N/A	OFF/ON	R/W	53775	D20F	OFF	
	Fan Trip	N/A	OFF/ON	R/W	53782	D216	ON	
	Communications Trip	N/A	OFF/ON	R/W	53796	D224	ON	
	Shut Down (1)	N/A	OFF/ON	R/W	53769	D209	ON	
	Shut Down (2)	N/A	OFF/ON	R/W	53770	D20A	ON	
	Thyristor Firing Trip	N/A	OFF/ON	R/W	53774	D20E	ON	
	Motor Side Phase Loss	N/A	OFF/ON	R/W	53777	D211	ON	
	Sensing Fault Trip	N/A	OFF/ON	R/W	53781	D215	ON	
	Thermal Sensor Trip	N/A	OFF/ON	R/W	53768	D208	ON	
	External Trip	N/A	OFF/ON	R/W	53795	D223	ON	
Operation 1 Trip	N/A	OFF/ON	R/W	53799	D227	OFF		
Operation 2 Trip	N/A	OFF/ON	R/W	53800	D228	ON		
Input Side Phase Loss	N/A	OFF/ON	R/W	53762	D202	ON		
Voltage Imbalance Trip	N/A	OFF/ON	R/W	53766	D206	OFF		
	Firing Mode	N/A	IN-LINE/IN-DELTA	R/W	128	80	In-Line	
Legacy Mode	Legacy Delta Mode	N/A	OFF/ON	R/W	192	C0	OFF	
	Legacy OL Display	N/A	OFF/ON	R/W	193	C1	OFF	
	Legacy 3	N/A	OFF/ON	R/W	194	C2	ON	
	Legacy 4	N/A	OFF/ON	R/W	195	C3	OFF	
	Legacy 5	N/A	OFF/ON	R/W	196	C4	OFF	

Operation

5.7.1 'Advanced' Category (continued)

Group	Parameter	Units	Range	Read/Write	Modbus		Default Setting	User Setting
					Dec	Hex		
Auto Reset	Auto Reset	N/A	OFF/ON	R/W	20736	5100	Off	
	Reset Delay	s	0 to 7200	R/W	20737	5101	0	
	Reset Attempts	N/A	0 to 10	R/W	20738	5102	0	
	Trip Free Time	s	0 to 7200	R/W	20739	5103	600	
	Input Side Phase Loss	N/A	OFF/ON	R/W	20801	5141	ON	
	Motor Side Phase Loss	N/A	OFF/ON	R/W	20804	5144	ON	
	Overload	N/A	OFF/ON	R/W	20813	514D	ON	
	Thyristor Firing	N/A	OFF/ON	R/W	20803	5143	ON	
	Sensing Fault	N/A	OFF/ON	R/W	20807	5147	ON	
	Thermal	N/A	OFF/ON	R/W	20802	5142	ON	
	Low Current	N/A	OFF/ON	R/W	20811	514B	ON	
	Current Limit time Out	N/A	OFF/ON	R/W	20812	514C	ON	
	Shearpin	N/A	OFF/ON	R/W	20814	514E	ON	
	Current Sensor	N/A	OFF/ON	R/W	20823	5157	ON	
	Control Voltage Low	N/A	OFF/ON	R/W	20806	5146	ON	
	Fan	N/A	OFF/ON	R/W	20808	5148	ON	
	External	N/A	OFF/ON	R/W	20816	5150	ON	
	Communications	N/A	OFF/ON	R/W	20817	5151	ON	
	Bypass	N/A	OFF/ON	R/W	20818	5152	ON	
	PTC Thermistor	N/A	OFF/ON	R/W	20815	514F	OFF	
Phase Rotation	N/A	OFF/ON	R/W	20821	5155	OFF		
Operation 1	N/A	OFF/ON	R/W	20826	515A	ON		
Operation 2	N/A	OFF/ON	R/W	20822	5156	ON		
Operation 4	N/A	OFF/ON	R/W	20826	515A	ON		
Operation 5	N/A	OFF/ON	R/W	20824	5158	ON		

Operation

5.7.2 'Input/Output' (I/O) Category

Group	Parameter	Units	Range	Read / Write	Modbus		Default Setting	User Setting
					Dec	Hex		
Digital Inputs	Digital Input Voltage	V	230Vac, 110Vac or 24Vdc	R/W	10880	2A80	230Vac	
	Control Method	–	Local Touch Screen User Programmable Two Wire Control Three Wire Control Modbus	R/W	59392	E800	Local Touch Screen	
	Digital Input 1 (D1-1I) → Select Function	–	Off Start/Stop Freeze Ramp Reset iERS External Trip	R/W	10944	2AC0	Start/ Stop	
	Digital Input 1 (D1-1I) → High Input =1 if On	N/A	OFF/ON	R/W	11264	2C00	ON	
	Digital Input 2 (D1-2I) → Select Function	–	same as DI-1I function selections	R/W	10945	2AC1	OFF	
	Digital Input 2 (D1-2I) → High Input =1 if On	N/A	OFF/ON	R/W	11266	2C02	ON	
	Digital Input 3 (D2-1I) → Select Function	–	same as DI-1I function selections	R/W	10946	2AC2	Reset	
	Digital Input 3 (D2-1I) → High Input =1 if On	N/A	OFF/ON	R/W	11268	2C04	ON	
	Digital Input 4 (D2-2I) → Select Function	–	same as DI-1I function selections	R/W	10947	2AC3	OFF	
	Digital Input 4 (D2-2I) → High Input =1 if On	N/A	OFF/ON	R/W	11270	2C06	ON	
Digital Outputs	Digital Output 1 N/C (12) → Select Function (DO1)	–	Off Ready Enabled Error Running End of Start Current Limit iERS Active Auto Reset Pending Auto Reset Exceeded Shearpin Low Current	R/W	11584	2D40	Error	
	Digital Output 1 N/C (12) → High Output =1 if On	N/A	OFF/ON	R/W	11904	2E80	ON	
	Digital Output 2 N/O (24) → Select Function (DO2)	–	same as DO1 function selections	R/W	11585	2D41	Error	
	Digital Output 2 N/O (24) → High Output =1 if On	N/A	OFF/ON	R/W	11906	2E82	ON	
	Digital Output 3 N/O (34) → Select Function (DO3)	–	same as DO1 function selections	R/W	11586	2D42	Running	
Digital Output 3 N/O (34) → High Output =1 if On	N/A	OFF/ON	R/W	11908	2E84	ON		

Operation

5.7.2 'Input/Output' (I/O) Category (continued)

Group	Parameter	Units	Range	Read/Write	Modbus		Default Setting	User Setting
					Dec	Hex		
Digital Outputs (continued)	Digital Output 4 N/O (44) → Select Function (DO4)	–	same as DO1 function selections	R/W	11587	2D43	End Of Start	
	Digital Output 4 N/O (44) → High Output =1 if On	N/A	OFF/ON	R/W	11910	2E86	ON	
	Digital Output 5 N/O (54) → Select Function (DO5)	–	same as DO1 function selections	R/W	11588	2D44	Running	
	Digital Output 5 N/O (54) → High Output =1 if On	N/A	OFF/ON	R/W	11912	2E88	ON	
Analog Inputs	Analog Input Type	N/A	0–10V/4–20mA	R/W	9600	2580	0–10V	
	Select Function	–	Off Current Limit Start Current Shearpin Current Overload	R/W	9664	25C0	OFF	
	Scaling Level	–	Dependent on selected function	R/W	9728	2600	16,384	
Analog Outputs	Analog Output Type	N/A	0–10V/4–20mA	R/W	8960	2300	0–10V	
	Select Function	–	Off I Measured Overload P-Total	R/W	9024	2340	OFF	
	Scaling Level	–	Dependent on selected function	R/W	9088	2380	0	
	PTC Motor Thermistor Trip	–	OFF/ON	R/W	53794	D222	OFF	

Operation

5.7.3 'Monitor' Category

Group	Parameter	Units	Range	Read/Write	Modbus		Default Setting	User Setting
					Dec	Hex		
Monitoring	Line Frequency	Hz	45 to 65	Read	32000	7D00	n/a	–
	Phase Rotation	–	L1-L2-L3 or L1-L3-L2	Read	32064	7D40	L1-L2-L3	–
	I1	A	0 to 10,000	Read	33536	8300	0	–
	I2	A	0 to 10,000	Read	33538	8302	0	–
	I3	A	0 to 10,000	Read	33540	8304	0	–
	Current I rms	A	0 to 10,000	Read	32896	8080	0	–
	V1	V	0 to 1000	Read	33920	8480	0	-
	V2	V	0 to 1000	Read	33921	8481	0	-
	V3	V	0 to 1000	Read	33922	8482	0	-
	Voltage Vrms	V	0 to 1000	Read	32960	80C0	0	–
	HeatSink Temp	°C	-20°C to 80°C	Read	36544	8EC0	ambient	–
	Real Power Factor	–	0 to 1	Read	33024	8100	0	–
	True Power P	kW	0 to 10,000	Read	34688	8780	0	–
	Apparent Power S	kVA	0 to 10,000	Read	34816	8800	0	–
	Reactive Power Q	kVAR	0 to 10,000	Read	34944	8880	0	–
	iERS Saving Level	%	0 to 100	Read	35008	88C0	0	–
	Delay Angle	degree	0° to 55°	Read	22400	5780	0	–
	Backstop	degree	0° to 55°	Read	23040	5A00	0	–
	Delay Max	degree	0° to 55°	Read	22464	57C0	0	–
	Pres PF Degrees	degree	0° to 90°	Read	21824	5540	0	–
	Ref PF Degrees	degree	0° to 90°	Read	21760	5500	0	–
	Start Saving Level	%	50% to 80% of mtr	Read	21320	5348	80%	–
	Last Peak (Start) Current	A	0 to 10,000	Read	38400	9600	0	–
	Motor Thermistor	–	0 to 1024	Read	10432	28C0	0	–
	Overload	%	0 to 100	Read	33408	8280	0	–
	Restart Pending	N/A	YES/NO	Read	37376	9200	NO	–
	Restarts Exceeded	N/A	YES/NO	Read	37568	92C0	NO	–
	Reset Delay	s	0 to 7200	R/W	20737	5101	0	–
	Reset Attempts	N/A	0 to 10	R/W	20738	5102	0	–
	Trip Free Time	s	0 to 7200	R/W	20739	5103	600	–
	Trip Event	N/A	100 to 2700	Read	20867	5183	0	–
	Dynamic Reset	%	0 to 100	Read	33409	8281	0	–

Operation

5.7.4 'Log' Category

Group	Parameter	Units	Range	Read/ Write	Modbus		Default Setting	User Setting
					Dec	Hex		
Trip Log	Last Trip	–	0 to 65,535	Read	60608	ECC0	0	–
	Last Trip -1	–	0 to 65,535	Read	60609	ECC1	0	–
	Last Trip -2	–	0 to 65,535	Read	60610	ECC2	0	–
	Last Trip -3	–	0 to 65,535	Read	60611	ECC3	0	–
	Last Trip -4	–	0 to 65,535	Read	60612	ECC4	0	–
	Last Trip -5	–	0 to 65,535	Read	60613	ECC5	0	–
	Last Trip -6	–	0 to 65,535	Read	60614	ECC6	0	–
	Last Trip -7	–	0 to 65,535	Read	60615	ECC7	0	–
	Last Trip -8	–	0 to 65,535	Read	60616	ECC8	0	–
	Last Trip -9	–	0 to 65,535	Read	60617	ECC9	0	–
Start Current Log	Last Peak Start Current	A	0 to 10,000	Read	38400	9600	0	–
	Last Peak Start Current -1	A	0 to 10,000	Read	38402	9602	0	–
	Last Peak Start Current -2	A	0 to 10,000	Read	38404	9604	0	–
	Last Peak Start Current -3	A	0 to 10,000	Read	38406	9606	0	–
	Last Peak Start Current -4	A	0 to 10,000	Read	38408	9608	0	–
	Last Peak Start Current -5	A	0 to 10,000	Read	38410	960A	0	–
	Last Peak Start Current -6	A	0 to 10,000	Read	38412	960C	0	–
	Last Peak Start Current -7	A	0 to 10,000	Read	38414	960E	0	–
	Last Peak Start Current -8	A	0 to 10,000	Read	38416	9610	0	–
	Last Peak Start Current -9	A	0 to 10,000	Read	38418	9610	0	–

Operation

5.7.4 'Log' Category (continued)

Group	Parameter	Units	Range	Read/Write	Modbus		Default Setting	User Setting
					Dec	Hex		
Stop Current Log	Last Peak Stop Current	A	0 to 10,000	Read	39040	9880	0	–
	Last Peak Stop Current -1	A	0 to 10,000	Read	39042	9882	0	–
	Last Peak Stop Current -2	A	0 to 10,000	Read	39044	9884	0	–
	Last Peak Stop Current -3	A	0 to 10,000	Read	39046	9886	0	–
	Last Peak Stop Current -4	A	0 to 10,000	Read	39048	9888	0	–
	Last Peak Stop Current -5	A	0 to 10,000	Read	39050	988A	0	–
	Last Peak Stop Current -6	A	0 to 10,000	Read	39052	988C	0	–
	Last Peak Stop Current -7	A	0 to 10,000	Read	39054	988E	0	–
	Last Peak Stop Current -8	A	0 to 10,000	Read	39056	9890	0	–
	Last Peak Stop Current -9	A	0 to 10,000	Read	39058	9892	0	–
Temperature Log	Last Temperature	°C	-20°C to 80°C	Read	39680	9B00	ambient	–
	Last Temperature -1	°C	-20°C to 80°C	Read	39681	9B01	ambient	–
	Last Temperature -2	°C	-20°C to 80°C	Read	39682	9B02	ambient	–
	Last Temperature -3	°C	-20°C to 80°C	Read	39683	9B03	ambient	–
	Last Temperature -4	°C	-20°C to 80°C	Read	39684	9B04	ambient	–
	Last Temperature -5	°C	-20°C to 80°C	Read	39685	9B05	ambient	–
	Last Temperature -6	°C	-20°C to 80°C	Read	39686	9B06	ambient	–
	Last Temperature -7	°C	-20°C to 80°C	Read	39687	9B07	ambient	–
	Last Temperature -8	°C	-20°C to 80°C	Read	39688	9B08	ambient	–
	Last Temperature -9	°C	-20°C to 80°C	Read	39689	9B09	ambient	–
Overload Log	Last Overload	%	0 to 100	Read	40320	9D80	0	–
	Last Overload -1	%	0 to 100	Read	40321	9D81	0	–
	Last Overload -2	%	0 to 100	Read	40322	9D82	0	–
	Last Overload -3	%	0 to 100	Read	40323	9D83	0	–
	Last Overload -4	%	0 to 100	Read	40324	9D84	0	–
	Last Overload -5	%	0 to 100	Read	40325	9D85	0	–
	Last Overload -6	%	0 to 100	Read	40326	9D86	0	–
	Last Overload -7	%	0 to 100	Read	40327	9D87	0	–
	Last Overload -8	%	0 to 100	Read	40328	9D88	0	–
	Last Overload -9	%	0 to 100	Read	40329	9D89	0	–
Totals Log	Number of Starts	–	0 to 4,294,836,225	Read	35840	8C00	0	–
	Motor Running Time	–	0 to 4,294,836,225	Read	35904	8C40	0	–
	Control Supply On Time	–	0 to 4,294,836,225	Read	35606	8C42	0	–
	Download Log File	–	–	R/W	n/a	n/a	–	–
	Clear Trip Log	–	–	R/W	n/a	n/a	–	–







Operation

5.7.5 'Device' Category

Group	Parameter	Units	Range	Read/ Dec	Modbus		Default Setting	User Setting
					Dec	Hex		
	Update Firmware	–	–	R/W	–	–	–	
	Date	–	current date	R/W	–	–	–	
	Time	hh:mm:ss	GMT/local	R/W	14720	3980	GMT	
	Language	–	refer to the "Parameter Details" section for list of available languages	R/W	-	-	English	
	Passcode	–	0 to 255 per Byte	R/W	-	-	n/a	
	Backlight Timeout	s	0 to 3,600	R/W	-	-	60	
Network	Modbus Network Address	–	1 to 32	R/W	16000	3E80	1	
	Modbus Network Baud Rate	Baud	9,600 19,200 38,400 57,600 115,200	R/W	16064	3EC0	19,200	
	Modbus Network Parity	–	none/odd/even	R/W	16128	3F00	even	
	Modbus Network Traffic LEDs	N/A	OFF/ON	R/W	14080	3700	OFF	
	Anybus/ModbusTCP/EtherNetIP	–	Address Serial Number Firmware Version Connection	Read	–	–	–	–
	Timeout	ms	0 to 60,000	R/W	15808	3DC0	5,000	
	Reset Defaults	–	Yes/No	R/W	62080	F280	No	
	About	–	VMX-Synergy Plus™ model #, serial #, software versions	Read	–	–	–	–
	Screen Lock	N/A	OFF/ON	R/W	–	–	OFF	
	Date Format	–	dd/mm/yyyy mm/dd/yyyy	R/W	–	–	dd/mm/yyyy	
	Temperature Format	degrees	°C/°F	R/W	–	–	°C	
	Parameters to USB		Yes/No	R/W	–	–	No	
	Parameters from USB		Yes/No	R/W	–	–	No	
	Service Code	for manufacturer's use only				13120	3340	

Operation

5.8 Auto Setup Menu

Menu	Description	Min	Max	Default	Unit	Reg. Type
PNU 19200 Auto Setup   Application:	<p>The Unit has numerous preset applications built in as standard.</p> <p>Select the application best suited to the motor load.</p> <p>The selected application will automatically change several parameters and functions.</p> <p>Depending on the application loaded the "Trip Class" may also change.</p> <p>Refer to the Full User Manual for more details..</p>	Default	End of list	Default		Read/Write
PNU 25664 Auto Setup   Trip Class	<p>The Trip Class is a numeric value that correlates the trip time with overload level.</p> <p>Select Trip Class according to application requirements.</p> <p>The trip time depends on the selected Trip Class. The duration of the overload and the level of the over current.</p> <p>Refer to the Motor Overload 'cold' trip curves given in the Quick Start Guide.</p> <p>When "Class 20" or "Class30" are selected the Unit current rating (i-Unit) will be reduced to a lower value (i-rated).</p>	Trip Class 10	Trip Class 30	Trip Class 10		Read/Write
PNU 25728 Auto Setup   Motor Current	<p>This should be set to the Full Load Current shown on the motor plate.</p> <p>The overload works with multiples of the set "Motor Current" (i-motor).</p> <p>Also referred to as Motor FLA (I-motor)</p>	10% I-unit	100% I-rated	100% I-rated	A	Read/Write

Operation

5.8 Auto Setup Menu (continued)

Menu	Description	Min	Max	Default	Unit	Reg. Type
<p>PNU 59392</p> <p>Auto Setup</p> <p style="text-align: center;">↓</p> <p style="text-align: center;">↓</p> <p>Control Method</p>	<p>Local Touch Screen : Control using the buttons on the keypad.</p> <p>User Programmable : Control using the terminals. Function defined in "I/O" menu.</p> <p>Two Wire Control : Control using terminals. Functions fixed as shown on screen.</p> <p>Three Wire Control : Control using terminals. Functions fixed as shown on screen.</p> <p>Modbus Network : Control via remote Modbus network or Modbus TCP</p>	Local Touch Screen	Modbus	Local Touch Screen		Read/Write
<p>PNU 10880</p> <p>Auto Setup</p> <p style="text-align: center;">↓</p> <p style="text-align: center;">↓</p> <p>Digital Input Voltage</p>	<p>The digital inputs D1-1I D1-2I D2-1I D2-2I are designed to work with a range of control supplies</p> <p>230V : 'Active high level' Input voltage must be in the range 195.5V - 253V</p> <p>110V : 'Active high level' Input voltage must be in the range 93.5V - 132V</p> <p>24V : 'Active high level ' input voltage must be in the range 20.4V-26.4V</p> <p> It is important to ensure the "Digital input Voltage" corresponds to the voltage applied to the input. Failure to do so may result in damage</p>	230V	24Vdc	230V		Read/Write





Operation

5.9 Advanced Menu

Menu	Description	Min	Max	Default	Unit	Reg. Type
PNU 62144 Advanced ↓ ↓ Save Parameters	Saves all Read /Write parameters to non volatile memory Yes : Parameters are permanently written No : Parameters remain changed until next power cycle	No	Yes	No		Read/Write
PNU 19840 Advanced Automatic Settings ↓ Automatic Pedestal	Automatically controls the starting torque. On: The initial torque is increased until the motor starts to rotate at a moderate speed. Off: The initial torque is defined by the "Start Pedestal".	Off	On	Off		Read/Write
PNU 20352 Advanced Automatic Settings ↓ Automatic Ramp	Automatically controls the torque applied to the motor during the soft start. On: The torque is adjusted to suit the load. Off: The ramp time depends on the "Start Time" and "Current Limit".	Off	On	Off		Read/Write
PNU 19968 Advanced Automatic Settings ↓ Automatic End Start (1)	Automatically controls the time taken for the motor to start. On : The ramp time is shortened if the motor is at speed before the end of the "Start Time" Off: The ramp time depends on the "Start Time" and "Current Limit"	Off	On	Off		Read/Write
PNU 20160 Advanced Automatic Settings ↓ Automatic Stop	Automatically controls the soft stop to suit the application. This feature is particularly useful with pumping applications. On: If the motor is lightly loaded it decelerates rapidly to the point where the soft stop becomes useful. Off: The deceleration to the point where the soft stop becomes useful, will be slower.	Off	On	Off		Read/Write



Operation

5.9 Advanced Menu (continued)

Menu	Description	Min	Max	Default	Unit	Reg. Type
PNU 20608 Advanced Automatic Settings  Automatic Stop Profile	Adjusts the response of the "Automatic Stop" Increase if the motor speed doesn't drop quickly enough. . When the value is set to zero the "Automatic Stop" is effectively disabled	0	100	50	%	Read/Write
PNU 20416 Advanced Automatic Settings  Automatic End Stop	Automatically controls the "Stop Time" On : The ramp time is shortened if the motor reaches a very low speed before the end of the "Stop Time" Off: The ramp time " depends on the "Stop Time" and "Current Limit"	Off	On	Off		Read/Write
PNU 20480 Advanced Automatic Settings  Automatic Impact Load	Automatically controls the maximum iERS saving level. On : The maximum iERS saving level ("BackStop") is reset to maximum during each load cycle. Off : The saving potential may be reduced on applications with heavy load cycles. Such as injection moulding machines.	Off	On	Off		Read/Write
PNU 20224 Advanced Automatic Settings  Auto Smooth Stop	Automatically controls the soft stop to eliminate oscillations that can occur towards the end of the ramp On : The soft stop is adjusted when oscillations are detected. Refer to "Auto smoothing Level" Off : The soft stop is unadjusted and torque fluctuations may cause instability. This can often occur in pumping applications.	Off	On	Off		Read/Write
PNU 20672 Advanced Automatic Settings  Auto Smoothing Level	Adjusts the response of the "Automatic smoothing" Increase to provide a greater smoothing effect If there are torque fluctuations that occur during the soft stop. When set to zero the smoothing is effectively disabled.	10	100	50	%	Read/Write

Operation

5.9 Advanced Menu (continued)

Menu	Description	Min	Max	Default	Unit	Reg. Type
PNU 19904 Advanced Automatic Settings  Automatic End Start (2)	Automatically controls the time taken for the motor to start On : The ramp time is shortened if torque fluctuations occur before the end of the "Start Time" Off: The ramp time depends on the "Start Time" and "Current Limit"	Off	On	Off		Read/Write
PNU 20032 Advanced Automatic Settings  Automatic End Start (3)	Automatically controls the time taken for the motor to start On : The ramp time is shortened if torque fluctuations occur before the end of the "Start Time" Off: The ramp time depends on the "Start Time" and "Current Limit"	Off	On	Off		Read/Write
PNU 768 Advanced Automatic Settings  Rate End Start (3)	Adjusts the response of the "Automatic End Start (3)" Increase to provide a greater smoothing effect If there are torque fluctuations that occur during the soft start. When set to zero the smoothing is effectively disabled.	0	100	%		Read/Write
PNU 7104 Advanced Start Settings  Start Time	Time taken to soft start from the "Start Pedestal" to the end of the start Normally set between 5 and 30 seconds. Actual time to get to full voltage depends on the "Start Current Limit Level". If set too long the motor can be at speed before the end of the time set. Refer to "Automatic End Start"	1	300	10	s	Read/Write
PNU 704 Advanced Start Settings  Start Pedestal	Percentage of the supply voltage applied to motor at the beginning of the soft start. Increase to provide more torque If the load fails to break away. Decrease if the motor accelerates too quickly.	10	100	20	%	Read/Write



Operation

5.9 Advanced Menu (continued)

Menu	Description	Min	Max	Default	Unit	Reg. Type
PNU 53790 Advanced Start Settings Start Current Limit Start Current Limit Trip	<p>Selects trip or continue if the current limit has been active for too long.</p> <p>On: The Unit will trip.</p> <p>Off: The start will continue regardless of the motor current level.</p>	Off	On	On		Read/Write
PNU 26880 Advanced Start Settings Start Current Limit Start Current Limit Level	<p>The current in Amps at which the soft Start ramp is held.</p> <p>Normally set to 350% of motor FLC. Increase if motor fails to accelerate at required rate.</p> <p>The "Current Limit Level" will affect actual time to start. If set too low the motor may not accelerate to full speed.</p>	50% I-motor	450% I-unit	350% I-motor	A	Read/Write
PNU 26944 Advanced Start Settings Start Current Limit Start Current Limit Time	<p>The maximum time allowed for the current limit.</p> <p>If the current limit is still active at the end of this period, the Unit will either 'Trip' or 'continue'.</p>	1	600	30	s	Read/Write
PNU 320 Advanced Start Settings Kick Start Kick Start	<p>Applies a short duration torque pulse to dislodge 'sticky' loads</p> <p>On : The torque pulse is applied at start-up when complete the torque drops to the "Start Pedestal"</p> <p>Off: The initial starting torque is defined by the "Start Pedestal"</p>	Off	On	Off		Read/Write
PNU 7040 Advanced Start Settings Kick Start Kick Start Time	<p>Time that the torque pulse is applied to load</p> <p>Increase to provide more torque If the load fails to break away.</p> <p>Decrease if the motor accelerates too quickly.</p>	10	2000	ms		Read/Write



Operation

5.9 Advanced Menu (continued)

Menu	Description	Min	Max	Default	Unit	Reg. Type
PNU 640 Advanced Start Settings Kick Start Kick Start Pedestal	<p>Percentage of the supply voltage applied to the motor during the 'kick' period.</p> <p>Increase to provide more torque If the load fails to break away.</p> <p>Decrease if the motor accelerates too quickly.</p>	30	80	75	%	Read/Write
PNU 8320 Advanced Start Settings  Contactor Delay	<p>Time allowed for external contactors to close.</p> <p>Increase if contactors are driven by buffer relays or motor trips on phase loss when start signal applied.</p> <p>Decrease if response to start signal needs to be improved.</p>	20	60000	160	ms	Read/Write
PNU 7296 Advanced Stop Settings  Stop Time	<p>The time taken to soft stop from full voltage or the iERS level to the 'Stop Pedestal'.</p> <p>Normally set between 15 and 60 seconds. Actual time to get to 'Stop Pedestal' depends on the "Stop Current Limit Level".</p> <p>If set too long the motor may reach zero speed before the end of the time set. Refer to "Automatic End Stop".</p>	0	300	0	s	Read/Write
PNU 896 Advanced Stop Settings  Stop Pedestal	<p>Percentage of the supply voltage applied to the motor at the end of the soft stop.</p> <p>Increase if the motor crawls at the end of the soft stop.</p> <p>Decrease if a greater soft-stop effect is required at the end of the ramp.</p>	10	40	10	%	Read/Write
PNU 53791 Advanced Stop Settings Stop Current Limit Stop Current Limit Trip	<p>Selects trip or continue if the stop current limit has been active for too long.</p> <p>On: The Unit will trip.</p> <p>Off: The stop will continue regardless of the motor current level.</p>	Off	On	Off		Read/Write

Operation

5.9 Advanced Menu (continued)

Menu	Description	Min	Max	Default	Unit	Reg. Type
PNU 28800 Advanced Stop Settings Stop Current Limit Stop Current Limit Level	<p>The current in Amps at which the soft stop ramp is not allowed to go above.</p> <p>Normally set to 350% motor FLC. Increase if motor decelerates too rapidly.</p> <p>The current limit level will affect actual time to stop the motor.</p>	100% I-motor	450% I-unit	350% I-motor	A	Read/Write
PNU 28864 Advanced Stop Settings Stop Current Limit Stop Current Limit Time	<p>The maximum time allowed for the current limit.</p> <p>If the current limit is still active at the end of this period, the Unit will either trip or continue.</p>	1	300	10	s	Read/Write
PNU 25728 Advanced Motor Protection  Motor Current	<p>This should be set to the Full Load Current shown on the motor plate.</p> <p>The overload works with multiples of the set "Motor Current" (i-motor).</p> <p>Also referred to as Motor FLA (I-motor).</p>	10% I-unit	100% I-rated	100% I-rated	A	Read/Write
PNU 25664 Advanced Motor Protection  Trip Class	<p>The trip class is a numeric value that correlates the trip time with overload level.</p> <p>Select Trip class according to application requirements.</p> <p>The trip time depends on the selected Trip Class. The duration of the overload and the level of the over current.</p> <p>Refer to the Motor Overload 'cold' trip curves given in the Quick Start Guide.</p> <p>When "Class 20" or "Class 30" are selected the Unit current rating (i-Unit) will be reduced to a lower value (i-rated).</p>	Trip Class 10	Trip Class 30	Trip Class 10		Read/Write





Operation

5.9 Advanced Menu (continued)

Menu	Description	Min	Max	Default	Unit	Reg. Type
PNU 53787 Advanced Motor Protection Low Current Settings Low Current Trip	<p>This can be used to detect if the motor is running lightly loaded.</p> <p>On: The Unit will trip. This feature is not active during soft start and soft stop.</p> <p>Off: The Unit will continue to operate regardless of motor current.</p>	Off	On	Off		Read/Write
PNU 26304 Advanced Motor Protection Low Current Settings Low Current Trip Level	<p>The current in Amps that will cause a trip.</p> <p>A trip will occur if the motor current is less than the "Trip Level" for the "Trip Time".</p>	25% I-motor	100% I-motor	25% I-motor	A	Read/Write
PNU 26368 Advanced Motor Protection Low Current Settings Low Current Trip Time	<p>The trip time for the Low current trip.</p> <p>A trip will occur if the motor current is less than the "Trip Level" for the "Trip Time".</p>	100	9000	100	ms	Read/Write
PNU 53793 Advanced Motor Protection Shearpin Settings Shearpin Trip	<p>The shearpin is an electronic equivalent of a mechanical shearpin.</p> <p>On : The Unit will trip. This feature is not active during soft start, dwell period and soft stop.</p> <p>Off: The Unit will continue to operate regardless of motor current level.</p>	Off	On	On		Read/Write
PNU 27584 Advanced Motor Protection Shearpin Settings Shearpin Trip Current	<p>The current in Amps that will cause a "Shearpin Trip".</p> <p>A trip will occur if the motor current is greater than the "Trip Level" for the "Trip Time".</p>	100% I-motor	450% I-motor	350% I-motor	A	Read/Write
PNU 27648 Advanced Motor Protection Shearpin Settings Shearpin Trip Time	<p>The trip time for the Shearpin trip.</p> <p>A trip will occur if the motor current is greater than the "Trip Level" for the "Trip Time".</p>	100	9000	100	ms	Read/Write





Operation

5.9 Advanced Menu (continued)

Menu	Description	Min	Max	Default	Unit	Reg. Type
PNU 53792 Advanced Motor Protection Overload Settings Overload Trip	<p>The Unit has an "Overload" function that is an electronic equivalent to a thermal overload.</p> <p>On : The Unit will trip when the "Overload" level (ModbusPNU 33408) exceeds 100%</p> <p>Off: The Unit will continue to operate regardless of motor current level. Not recommended.</p>	Off	On	On		Read/Write
PNU 28224 Advanced Motor Protection Overload Settings Overload Level	<p>Determines the level in Amps at which the overload will start.</p> <p>Normally set to 115% of the set motor current (i-motor).</p> <p>Reduce to speed up trip response.</p>	50% I-motor	125% I-motor	115% I-motor	A	Read/Write
PNU 21120 Advanced iERS  iERS	<p>Enables and disables the intelligent Energy Recovery System feature (iERS).</p> <p>On: The voltage to the motor will be regulated to ensure optimum efficiency.</p> <p>Off: The feature is disabled, and the motor operates at full voltage. Internal bypass closed.</p>	Off	On	Off		Read/Write
PNU 448 Advanced  Dynamic Reset	<p>Dynamically tracks the thermal capacity needed for a successful restart after an overload trip. It averages the thermal capacity consumed in the previous three successful starts and calculates a thermal capacity to Start.</p> <p>On: If there is insufficient capacity to start the unit it will be "inhibited" from starting.</p> <p>Off: If there is insufficient capacity to start the unit it will not be "inhibited" from starting</p>	Off	On	Off		Read/Write
PNU 384 Advanced  Motor Protection  Overload Settings  Trip Class Run	<p>This feature is only available for ANSI models.</p> <p>When selected it allows it allows a different overload class to be selected during the running period.</p> <p>Off: The overload will use the "Trip Class" selection when starting "Trip Class Run Value" selection when running.</p> <p>On: The overload will use the "Trip Class" selection for starting and running.</p>	Off	On	Off		Read/Write





Operation

5.9 Advanced Menu (continued)

Menu	Description	Min	Max	Default	Unit	Reg. Type
PNU 25668 Advanced  Motor Protection  Overload Settings  Trip Class Run Value	<p>This feature is only available for ANSI models.</p> <p>When selected it allows a different overload class to be selected during the running period.</p> <p>The trip time depends on the selected run trip class value, the duration of the overload and the level of the overcurrent.</p>	Trip Class 10	Trip Class 30	Trip Class 10		Read/Write
PNU 7360 Advanced iERS  Dwell Time	<p>The time from the End of the start to the point where the iERS saving mode becomes active.</p> <p>Normally set to 5 seconds to ensure the motor is at full speed before the iERS saving becomes active,</p> <p>Increase to allow time for the motor to stabilise.</p>	1	300	5	s	Read/Write
PNU 21184 Advanced iERS  iERS Rate	<p>Determines the rate at which the load is regulated during the iERS energy saving mode.</p> <p>During periods of instability the "Current Irms" and "True Power Factor" will oscillate rapidly.</p> <p>Increase if the application shows signs of instability.</p> <p>Reduce to increase the speed of response.</p>	0	100	25	%	Read/Write





Operation

5.9 Advanced Menu (continued)

Menu	Description	Min	Max	Default	Unit	Reg. Type
PNU 21376 Advanced iERS  iERS Level	Determines the maximum energy saving potential. Reduce if the application shows signs of instability. The amount of energy that can be saved may fall as the "iERS level" is reduced.	0	100	100	%	Read/Write
PNU 35200 Advanced iERS  Fixed Voltage	User settable voltage level for power calculations If a very high level of accuracy is required the user can input the 3-Phase voltage directly	100	500	100	V	Read/Write
PNU 35264 Advanced iERS  Fixed Voltage	Selects the source for the voltage value used in the power calculations. on: KW KVar and KVA are calculated using the "Fixed Voltage". off: KW KVar and KVA are calculated using the internally measured voltage.	Off	On	Off		Read/Write
PNU 59392 Advanced   Control Method	Local Touch Screen : Control using the buttons on the keypad. User Programmable : Control using the terminals. Function defined in "I/O" menu. Two Wire Control : Control using terminals. Functions fixed as shown on screen. Three Wire Control : Control using terminals. Functions fixed as shown on screen. Modbus Network : Control via remote Modbus network or Modbus TCP	Local Touch Screen	Modbus Network	Local Touch Screen		Read/Write





Operation

5.9 Advanced Menu (continued)

Menu	Description	Min	Max	Default	Unit	Reg. Type
PNU 44864 Advanced Trip Settings  Trip Sensitivity	Adjusts the reaction time to fault trips. Increase "Trip Sensitivity" to slow the response to fault trips. Sometimes useful on sites where electrical noise is causing nuisance tripping. This is a global setting. Increasing "Trip Sensitivity" will slow the response of nearly all the trips.	0	100	0	%	Read/Write
PNU 53765 Advanced Trip Settings  Keypad Trip	Detects if the communications bus has failed or become inactive between the keypad and the main unit. On :Keypad trip enabled. Off : Keypad trip disabled.	Off	On	On		Read/Write
PNU 53793 Advanced Trip Settings  Shearpin Trip	The shearpin is an electronic equivalent of a mechanical shearpin. On : The Unit will trip. This feature is not active during soft start, dwell period and soft stop. Off: The Unit will continue to operate regardless of motor current level.	Off	On	On		Read/Write
PNU 53792 Advanced Trip Settings  Overload Trip	The Unit has an "Overload" function that is an electronic equivalent to a thermal overload. On: The Unit will trip when the "Overload" capacity (ModbusPNU 33408) exceeds 100%. Off: The Unit will continue to operate regardless of motor current level.	Off	On	On		Read/Write





Operation

5.9 Advanced Menu (continued)

Menu	Description	Min	Max	Default	Unit	Reg. Type
PNU 53787 Advanced Trip Settings  Low Current Trip	<p>This can be used to detect if the motor is running lightly loaded.</p> <p>On: The Unit will trip. This feature is not active during soft start and soft stop.</p> <p>Off: The Unit will continue to operate regardless of motor current.</p>	Off	On	Off		Read/Write
PNU 53790 Advanced Trip Settings  Start Current Limit Trip	<p>Selects trip or continue if the current limit has been active for too long.</p> <p>On: The Unit will trip.</p> <p>Off: The start will continue regardless of the motor current level.</p>	Off	On	On		Read/Write
PNU 53791 Advanced Trip Settings  Stop Current Limit Trip	<p>Selects trip or continue if the stop current limit has been active for too long.</p> <p>On: The Unit will trip.</p> <p>Off: The stop will continue regardless of the motor current level.</p>	Off	On	Off		Read/Write
PNU 53794 Advanced Trip Settings  PTC Motor Thermistor Trip	<p>A single PTC motor thermistor or set of PTC motor thermistors can be connected to the PTC terminals.</p> <p>On: The Unit will trip if the motor thermistor exceeds its response temperature or the PTC input is open circuit.</p> <p>Off: The unit will not trip regardless of motor rotation.</p>	Off	On	Off		Read/Write
PNU 53808 Advanced Trip Settings  L1-L2-L3 Trip	<p>Determines if supply phase sequence is incorrect for motor rotation.</p> <p>On: Trips if the phase sequence is L1-L2-L3.</p> <p>Off: The unit will not trip regardless of motor rotation.</p>	Off	On	Off		Read/Write



Operation

5.9 Advanced Menu (continued)

Menu	Description	Min	Max	Default	Unit	Reg. Type
PNU 53807 Advanced Trip Settings  L1-L3-L2 Trip	<p>Determines if supply phase sequence is incorrect for motor rotation.</p> <p>On: Trips if the phase sequence is L1-L3-L2.</p> <p>Off: The unit will not trip regardless of motor rotation.</p>	Off	On	Off		Read/Write
PNU 53804 Advanced Trip Settings  Remote Start Trip	<p>For safety reasons the Unit will trip during some operations if the remote start signal is active.</p> <p>On: Trips if the remote start signal is active when the Unit is powered up or a reset is applied.</p> <p>Off: The Unit will not trip and may start unexpectedly if the start signal is accidentally left active.</p>	Off	On	On		Read/Write
PNU 53775 Advanced Trip Settings  Current Sensor Trip	<p>Detects if the internal current sensors have failed or reading a very low level.</p> <p>On: The Unit will trip if the internal current sensors fail or the current measured falls to a very low level.</p> <p>Off: Will continue to operate even if the sensor has failed. Measurements and overload protection may be affected.</p>	Off	On	Off		Read/Write
PNU 53782 Advanced Trip Settings  Fan Trip	<p>Detects if the cooling fans have failed.</p> <p>On: The Unit trips if the cooling fans fitted to the Unit fail.</p> <p>Off : The unit will continue to operate and is likely to trip on a thermal trip as the heatsink will not be sufficiently cooled</p>	Off	On	On		Read/Write

Operation

5.9 Advanced Menu (continued)

Menu	Description	Min	Max	Default	Unit	Reg. Type
PNU 53796 Advanced Trip Settings  Communications Trip	Detects if the communications bus has failed or become inactive. To keep the bus active there must be at least one Modbus read or write (any PNU) during the "Timeout ms" period (ModbusPNU 15808). On: Communication trip enabled. Off: Communication trip disabled.	Off	On	On		Read/Write
PNU 53769 Advanced Trip Settings  Shut Down (1)	This controls the soft stop improve stability On: The stop time is truncated if the motor experiences severe torque fluctuations during the soft stop. Off: Follows normal soft stop time.	Off	On	On		Read/Write
PNU 53770 Advanced Trip Settings  Shut Down (2)	This feature controls the soft stop improve stability. On: The stop time is truncated if the motor experiences severe torque fluctuations during the soft stop. Off: Follows normal soft stop time.	Off	On	On		Read/Write



The Shut Down Trips are in operation during the soft stop ramp.

At the end of the soft stop ramp, occasionally the motor can become unstable due to torque fluctuations.

If the torque fluctuations get too bad then VMX-Synergy Plus™ may trip, this could cause issues with the restart. With Shut Down Trips turned on, if the torque fluctuations are experienced VMX-Synergy Plus™ will automatically stop the soft stop ramp and let the motor coast to a full stop. This stops VMX-Synergy Plus™ tripping and allows for a restart without resetting a trip. This is normally only for a very small time due to torque fluctuations occurring at the end of a soft stop ramp. If a Shut Down occurs, then it is logged in the log file but will not affect the operation of VMX-Synergy Plus™. Both shut down trips have to do with rapid changes in power factor. Soft stop smoothing will keep shut down trips from happening.





Operation

5.9 Advanced Menu (continued)

Menu	Description	Min	Max	Default	Unit	Reg. Type
<p>PNU 53774</p> <p>Advanced</p> <p>Trip Settings</p> <p>↓</p> <p>Thyristor Firing Trip</p>	<p>Detects if there is a fault with one or more of the internal Thyristors or bypass relays.</p> <p>On: Trips if one or more of the Thyristors/bypass relays has failed short circuit. ISOLATE SUPPLY.</p> <p>Check by measuring the resistance between L1 -T1 L2 -T2 L3 -T3 (Anything < 10R is assumed short circuit).</p> <p>Off (not recommended): The Unit will attempt to start and run although the operation may be erratic.</p> <p>Operating in this mode for prolonged periods may result in SCR failure.</p>	Off	On	On		Read/Write
<p>PNU 53777</p> <p>Advanced</p> <p>Trip Settings</p> <p>↓</p> <p>Motor Side Phase Loss</p>	<p>Detects if there is a disconnection between the Unit output and the motor.</p> <p>On: Trips if there is a disconnection between the output side of the Unit and the motor.</p> <p>Off: The Unit will attempt to start and run although the operation may be erratic.</p> <p>Operating in this mode for prolonged periods may result in SCR failure.</p>	Off	On	On		Read/Write
<p>PNU 53781</p> <p>Advanced</p> <p>Trip Settings</p> <p>↓</p> <p>Sensing Fault Trip</p>	<p>Detects if there is a fault with operation of one or more of the internal Thyristors.</p> <p>On: Trips if one or more of the Thyristors fails to turn on properly.</p> <p>Off: The Unit will attempt to start and run although the operation may be erratic.</p> <p>Operating in this mode for prolonged periods may result in SCR failure.</p>	Off	On	On		Read/Write

Operation

5.9 Advanced Menu (continued)

Menu	Description	Min	Max	Default	Unit	Reg. Type
PNU 53768 Advanced Trip Settings  Thermal Sensor Trip	<p>Detects if the internal temperature sensor has malfunctioned.</p> <p>On: The Unit will trip if the internal temperature sensor malfunctions.</p> <p>Off: The Unit will continue to operate even if the temperature sensor has malfunctioned.</p> <p>Operating in this mode for prolonged periods may result in SCR failure.</p>	Off	On	On		Read/Write
PNU 53795 Advanced Trip Settings  External Trip	<p>Allows a trip to be forced using one of the digital inputs.</p> <p>On: Trips when the programmed input is active.</p> <p>Off: External Trip is disabled.</p>	Off	On	On		Read/Write
PNU 53799 Advanced Trip Settings  Operation 1 Trip	<p>Detects if the logging function has failed to operate normally.</p> <p>On : Operation 1 trip enabled. (Trip Code 2601-2699)</p> <p>Off: Operation 1 trip disabled.</p>	Off	On	Off		Read/Write
PNU 53800 Advanced Trip Settings  Operation 2 Trip	<p>Detects if the Control Board has failed to operate normally.</p> <p>On : Operation 2 trip enabled. (Trip Code 2401-2499)</p> <p>Off: Operation 2 trip disabled.</p>	Off	On	On		Read/Write

Operation

5.9 Advanced Menu (continued)







<p>PNU 53762 Advanced Trip Settings</p> <p style="text-align: center;">↓</p> <p>Input Side Phase Loss</p>	<p>Detects if there is a disconnection between the unit input and the three-phase supply when the motor is running.</p> <p>Advanced Trip Settings >>>>>>>> Input Side Phase Loss</p> <p>On : Trips if there is a disconnection between the input side of the unit and the three-phase supply when the motor is running.</p> <p>Off : The Unit will attempt to run although the operation may be erratic.</p> <p>Operating in this mode for prolonged periods may result in SCR failure</p>	Off	On	On	Read/Write
<p>PNU 53766 Advanced Trip Settings</p> <p style="text-align: center;">↓</p> <p>Voltage Imbalance Trip</p>	<p>Detects if there is an imbalance between the phases on the incoming three-phase supply</p> <p>On : Trips if there is an imbalance in the incoming three-phase supply.</p> <p>Off : The Unit will attempt to run although the operation may be erratic.</p> <p>Operating in this mode for prolonged periods may result in SCR failure</p>	Off	On	On	Read/Write
<p>PNU 128 Advanced</p> <p style="text-align: center;">↓</p> <p style="text-align: center;">↓</p> <p>Firing Mode</p>	<p>Set to correspond with Unit connection to the Motor.</p> <p>Refer to connection diagrams.</p> <p>In-Line: The Unit is connected in-line with a delta or star connected motor.</p> <p>In-Delta: The Unit is connected inside the Delta of the motor. The iERS function is disabled.</p>	In-Line	In-Delta	In-Line	Read/Write
<p>PNU 192 Advanced</p> <p style="text-align: center;">↓</p> <p style="text-align: center;">↓</p> <p>Legacy Delta Mode</p>	<p>Allows the Unit to be retro-fitted into "Delta" applications that previously used QFE/XFE (5MC).</p> <p>On: Operates in QFE/XFE (5MC) delta compatibility mode.</p> <p>Off: Operates normally. Refer to Unit Delta connection diagram in the Quick Start Guide.</p>	Off	On	Off	Read/Write

Operation

<p>PNU 193</p>		Off	On	Off		Read/Write
<p>Advanced</p> <p>↓</p> <p>Legacy Mode</p> <p>↓</p> <p>Legacy OL Display</p>	<p>Allows the overload percentage to be displayed as either 0% through to 100% (IEC Model), or 100% down to 0% (ANSI Model).</p> <p>On: Overload capacity shown is 100% (empty) to 0% (full).</p> <p>Off: Overload capacity is 0% (empty) to 100% (full).</p>					
<p>PNU 194</p> <p>↓</p> <p>Legacy Mode</p> <p>↓</p> <p>Legacy 3</p>	<p>For Future Development</p>	Off	On	Off		Read/Write
<p>PNU 195</p> <p>↓</p> <p>Legacy Mode</p> <p>↓</p> <p>Legacy 4</p>	<p>For Future Development</p>	Off	On	Off		Read/Write
<p>PNU 195</p> <p>↓</p> <p>Legacy Mode</p> <p>↓</p> <p>Legacy 5</p>	<p>For Future Development.</p>	Off	On	Off		Read/Write



Operation

5.9 Advanced Menu (continued)

Menu	Description	Min	Max	Default	Unit	Reg. Type
PNU 14144 Advanced   Main Contactor Control	<p>The unit is configured to start and stop when the main contactor opens and closes.</p> <p>On: When a zero stop time is set some faults will be ignored when main contactor opens.</p> <p>Off : When the contactor opens and the stop signal is given at the same time the unit may trip on "Phase Loss".</p>	Off	On	Off		Read/Write
PNU 28160 Advanced   Hand/Auto Control	<p>A Hand-Auto selection switch can be connected to Digital Input D1-2I to change the 'Control Method'</p> <p>This can be used to change the Start / Stop to 'Hand' if the Communications fails</p> <p>D1-2I = 0 : Control Method is set to "2 -Wire" (Hand)</p> <p>D1-2I = 1 : Control Method is set to "Modbus Network" (Auto)</p> <p>Hand : Input D1-1I = Start / Stop, Input D2-1I = Reset</p> <p>Auto : PNU 17920 = Start / Stop, PNU 18368 = Reset</p>	Off	On	On		Read/Write
PNU 20736 Advanced Auto Reset  Auto Reset	<p>Enables the Auto Reset Feature.</p> <p>On: The Auto Reset feature is Enabled.</p> <p>Off: The Auto Reset feature is disabled and all counters will be re-initialised.</p>	Off	On	Off		Read/Write
PNU 20737 Advanced Auto Reset  Reset Delay	<p>The delay between the trip event and the automatic reset, the unit will re-start following the reset if the start signal is active.</p> <p>If this is set to zero at any point the Auto Reset feature will terminate and the counters will be re-initialised.</p> <p>When the delay is active the Restart Pending parameter is set and the time remaining can be viewed in the monitor menu.</p>	0	7200	0	s	Read/Write

Operation

5.9 Advanced Menu (continued)

Menu	Description	Min	Max	Default	Unit	Reg. Type
PNU 20738 Advanced Auto Reset  Reset Attempts	<p>The number of restart attempts allowed before the Auto Reset terminates. If the Auto Reset has been successful, the counter is reset back to its maximum value when the unit has been running fault free for the Trip Free Time.</p> <p>If the Auto Restart has been unsuccessful the counters are re-initialised by applying a reset signal or removing the start signal.</p> <p>If set to zero at any point the Auto Reset feature will terminate and the counters will be re-initialised. The number of attempts remaining can be viewed in the Monitor menu.</p>	0	10	0		Read/Write
PNU 20739 Advanced Auto Reset  Trip Free Time	<p>The time the unit must be run trip free before the counters are re-initialised back to zero.</p> <p>If set to zero at any point the Auto Reset feature will terminate and the counters will be re-initialised.</p> <p>The Trip Free Time can be viewed in the Monitor menu.</p>	0	7200	600	s	Read/Write
PNU 20801 Advanced Auto Reset Reset Trips Input Side Phase Loss	<p>Allows the user to select whether the unit will auto reset if a Input Side Phase Loss Trip occurs</p> <p>On : The trip will auto reset when the Reset Delay reaches zero.</p> <p>Off : The trip will not auto reset</p>	Off	On	On		Read/Write
PNU 20804 Advanced Auto Reset Reset Trips Motor Side Phase Loss	<p>Allows the user to select whether the unit will auto reset if a Motor Side Phase Loss Trip occurs</p> <p>On : The trip will auto reset when the Reset Delay reaches zero.</p> <p>Off : The trip will not auto reset</p>	Off	On	On		Read/Write

Operation

5.9 Advanced Menu (continued)

<p>PNU 20813 Advanced Auto Reset Reset Trips Overload</p>	<p>Allows the user to select whether the unit will auto reset if an Overload Trip occurs.</p> <p>On: The trip will auto reset when the Reset Delay reaches zero.</p> <p>Off: The trip will not auto reset.</p>	Off	On	On		Read/Write
<p>PNU 20803 Advanced Auto Reset Reset Trips Thyristor Firing</p>	<p>Allows the user to select whether the unit will auto reset if a Thyristor Firing Trip occurs</p> <p>On: The trip will auto reset when the Reset Delay reaches zero.</p> <p>Off: The trip will not auto reset.</p>	Off	On	On		Read/Write
<p>PNU 20807 Advanced Auto Reset Reset Trips Sensing Fault</p>	<p>Allows the user to select whether the unit will auto reset if a Sensing Fault Trip occurs.</p> <p>On: The trip will auto reset when the Reset Delay reaches zero.</p> <p>Off: The trip will not auto reset.</p>	Off	On	On		Read/Write
<p>PNU 20802 Advanced Auto Reset Reset Trips Thermal</p>	<p>Allows the user to select whether the unit will auto reset if a Thermal Trip occurs</p> <p>On : The trip will auto reset when the Reset Delay reaches zero.</p> <p>Off : The trip will not auto reset</p>	Off	On	On		Read/Write
<p>PNU 20811 Advanced Auto Reset Reset Trips Low Current</p>	<p>Allows the user to select whether the unit will auto reset if a Low Current Trip occurs.</p> <p>On: The trip will auto reset when the Reset Delay reaches zero.</p> <p>Off: The trip will not auto reset.</p>	Off	On	On		Read/Write
<p>PNU 20812 Advanced Auto Reset Reset Trips Current Limit Time Out</p>	<p>Allows the user to select whether the unit will auto reset if a Current Limit Time Out Trip occurs.</p> <p>On: The trip will auto reset when the Reset Delay reaches zero.</p> <p>Off: The trip will not auto reset.</p>	Off	On	On		Read/Write

Operation

5.9 Advanced Menu (continued)

Menu	Description	Min	Max	Default	Unit	Reg. Type
PNU 20814 Advanced Auto Reset Reset Trips Shearpin	Allows the user to select whether the unit will auto reset if a Shearpin Trip occurs. On: The trip will auto reset when the Reset Delay reaches zero. Off: The trip will not auto reset.	Off	On	On		Read/Write
PNU 20823 Advanced Auto Reset Reset Trips Current sensor	Allows the user to select whether the unit will auto reset if a Current Sensor Trip occurs. On: The trip will auto reset when the Reset Delay reaches zero. Off: The trip will not auto reset.	Off	On	On		Read/Write
PNU 20806 Advanced Auto Reset Reset Trips Control Voltage Low	Allows the user to select whether the unit will auto reset if a Control Voltage Low Trip occurs Advanced Auto Reset Reset Trips Control Voltage Low On : The trip will auto reset when the Reset Delay reaches zero. Off : The trip will not auto reset	Off	On	On		Read/Write
PNU 20808 Advanced Auto Reset Reset Trips Fan	Allows the user to select whether the unit will auto reset if a Fan Trip occurs. On: The trip will auto reset when the Reset Delay reaches zero. Off: The trip will not auto reset.	Off	On	On		Read/Write
PNU 20816 Advanced Auto Reset Reset Trips External	Allows the user to select whether the unit will auto reset if an External Trip occurs. On: The trip will auto reset when the Reset Delay reaches zero. Off: The trip will not auto reset.	Off	On	Off		Read/Write
PNU 20817 Advanced Auto Reset Reset Trips Communications	Allows the user to select whether the unit will auto reset if a Communications Trip occurs. On: The trip will auto reset when the Reset Delay reaches zero. Off: The trip will not auto reset.	Off	On	On		Read/Write

Operation

5.9 Advanced Menu (continued)

Menu	Description	Min	Max	Default	Unit	Reg. Type
PNU 20818 Advanced Auto Reset Reset Trips Bypass	<p>Allows the user to select whether the unit will auto reset if a Bypass Trip occurs.</p> <p>On: The trip will auto reset when the Reset Delay reaches zero.</p> <p>Off: The trip will not auto reset.</p>	Off	On	Off		Read/Write
PNU 20815 Advanced Auto Reset Reset Trips PTC Thermistor	<p>Allows the user to select whether the unit will auto reset if a PTC Thermistor Trip occurs.</p> <p>On: The trip will auto reset when the Reset Delay reaches zero.</p> <p>Off: The trip will not auto reset.</p>	Off	On	Off		Read/Write
PNU 20821 Advanced Auto Reset Reset Trips Phase Rotation	<p>Allows the user to select whether the unit will auto reset if a Phase Rotation Trip occurs.</p> <p>On: The trip will auto reset when the Reset Delay reaches zero.</p> <p>Off: The trip will not auto reset.</p>	Off	On	On		Read/Write
PNU 20826 Advanced Auto Reset Reset Trips Operation 1	<p>Allows the user to select whether the unit will auto reset if an Operation 1 Trip occurs</p> <p>On : The trip will auto reset when the Reset Delay reaches zero.</p> <p>Off : The trip will not auto reset</p>	Off	On	On		Read/Write
PNU 20824 Advanced Auto Reset Reset Trips Operation 2	<p>Allows the user to select whether the unit will auto reset if an Operation 2 Trip occurs.</p> <p>On: The trip will auto reset when the Reset Delay reaches zero.</p> <p>Off: The trip will not auto reset.</p>	Off	On	On		Read/Write
PNU 20822 Advanced Auto Reset Reset Trips Operation 4	<p>Allows the user to select whether the unit will auto reset if an Operation 4 Trip occurs.</p> <p>On: The trip will auto reset when the Reset Delay reaches zero.</p> <p>Off: The trip will not auto reset.</p>	Off	On	On		Read/Write



Operation

5.9 Advanced Menu (continued)

Menu	Description	Min	Max	Default	Unit	Reg. Type
PNU 20827 Advanced Auto Reset Reset Trips Operation 5	Allows the user to select whether the unit will auto reset if an Operation 5 Trip occurs. On: The trip will auto reset when the Reset Delay reaches zero. Off: The trip will not auto reset.	Off	On	On		Read/Write

Operation

5.10 Input/Output Menu

Menu	Description	Min	Max	Default	Unit	Reg. Type
PNU 10880 I/O Digital Inputs  Digital Input Voltage	<p>The digital inputs D1-1I D1-2I D2-1I D2-2I are designed to work with a range of control supplies</p> <p>230V : 'Active high level' Input voltage must be in the range 195.5V - 253V</p> <p>110V : 'Active high level' Input voltage must be in the range 93.5V - 132V</p> <p>24V : 'Active high level ' input voltage must be in the range 20.4V-26.4V</p> <p> It is important to ensure the "Digital input Voltage" corresponds to the voltage applied to the input. Failure to do so may result in damage.</p>	230V	24Vdc	230V		Read/Write
PNU 59392 I/O Digital Inputs  Control Method	<p>Local Touch Screen : Control using the buttons on the keypad.</p> <p>User Programmable : Control using the terminals. Function defined in "I/O" menu.</p> <p>Two Wire Control : Control using terminals. Functions fixed as shown on screen.</p> <p>Three Wire Control : Control using terminals. Functions fixed as shown on screen.</p> <p>Modbus RTU : Control via remote Modbus RTU network or Modbus TCP</p>	Local Touch Screen	Modbus RTU	Local Touch Screen		Read/Write
PNU 10944 I/O Digital Inputs Digital Input 1 (D1-1I) Select Function	<p>Allows the Digital input (D1-1I) to be mapped to different functions.</p> <p>The selected function will change in proportion with the input.</p> <p>Digital inputs can only be mapped if the "Control Method" is set to "User Programmable".</p>	Off	End of list	Start/Stop		Read/Write

Operation

5.10 Input/Output Menu (continued)

Menu	Description	Min	Max	Default	Unit	Reg. Type
PNU 11264 I/O Digital Inputs Digital Input 1 (D1-1I) High Input = 1 Sets Value	Allows the polarity of the input to be reversed On : When the input is on the selected function will be on. Off : When the input is off the selected function will be on.	Off	On	On		Read/Write
PNU 10945 I/O Digital Inputs Digital Input 2 (D1-2I) Select Function	Allows the Digital input (D1-2I) to be mapped to different functions. The selected function will change in proportion with the input. Digital inputs can only be mapped if the "Control Method" is set to "User Programmable".	Off	End of list	Off		Read/Write
PNU 11266 I/O Digital Inputs Digital Input 2 (D1-2I) High Input = 1 Sets Value	Allows the polarity of the input to be reversed. On: When the input is on the selected function will be on. Off: When the input is off the selected function will be on.	Off	On	On		Read/Write
PNU 10946 I/O Digital Inputs Digital Input 3 (D2-1I) Select Function	Allows the Digital input (D2-1I) to be mapped to different functions. The selected function will change in proportion with the input. Digital inputs can only be mapped if the "Control Method" is set to "User Programmable".	Off	End of list	Reset		Read/Write
PNU 11268 I/O Digital Inputs Digital Input 3 (D2-1I) High Input = 1 Sets Value	Allows the polarity of the input to be reversed. On: When the input is on the selected function will be on. Off: When the input is off the selected function will be on.	Off	On	On		Read/Write

Operation

5.10 Input/Output Menu (continued)

Menu	Description		Min	Max	Default	Unit	Reg. Type
PNU 10947 I/O Digital Inputs Digital Input 4 (D2-2I) Select Function	<p>Allows the Digital input (D2-2I) to be mapped to different functions.</p> <p>The selected function will change in proportion with the input.</p> <p>Digital inputs can only be mapped if the "Control Method" is set to "User Programmable".</p>		Off	End of list	Off		Read/Write
PNU 11270 I/O Digital Inputs Digital Input 4 (D2-2I) High Input = 1 Sets Value	<p>Allows the polarity of the input to be reversed.</p> <p>On: When the input is on the selected function will be on.</p> <p>Off: When the input is off the selected function will be on.</p>		Off	On	On		Read/Write
PNU 11584 I/O Digital Outputs Digital Output 1 N/C(12) Select Function	<p>Allows the Digital output (N/C (12)) to be mapped to different functions.</p> <p>The digital output will change in accordance with the selected function</p>		Off	End of list	Error		Read/Write
PNU 11904 I/O Digital Outputs Digital Output 1 N/C(12) High Output = 1 When Value	<p>Allows the polarity of the output to be reversed.</p> <p>On: When the selected function is on the output will be on.</p> <p>Off: When the selected function is on the output is off.</p>		Off	On	On		Read/Write
PNU 11585 I/O Digital Outputs Digital Output 2 N/O(24) Select Function	<p>Allows the Digital output (N/O (24)) to be mapped to different functions.</p> <p>The digital output will change in accordance with the selected function</p>		Off	End of list	Error		Read/Write
PNU 11906 I/O Digital Outputs Digital Output 2 N/O(24) High Output = 1 When Value	<p>Allows the polarity of the output to be reversed.</p> <p>On: When the selected function is on the output will be on.</p> <p>Off: When the selected function is on the output is off.</p>		Off	On	On		Read/Write





Operation

5.10 Input/Output Menu (continued)

Menu	Description	Min	Max	Default	Unit	Reg. Type
PNU 11586 I/O Digital Outputs Digital Output 3 N/O(34) Select Function	<p>Allows the Digital output (N/O (34)) to be mapped to different functions.</p> <p>The digital output will change in accordance with the selected function</p>	Off	End of list	Running		Read/Write
PNU 11908 I/O Digital Outputs Digital Output 3 N/O(34) High Output = 1 When Value	<p>Allows the polarity of the output to be reversed.</p> <p>On: When the selected function is on the output will be on.</p> <p>Off: When the selected function is on the output is off.</p>	Off	On	On		Read/Write
PNU 11587 I/O Digital Outputs Digital Output 4 (N/O(44)) Select Function	<p>Allows the Digital output (N/O (44)) to be mapped to different functions.</p> <p>The digital output will change in accordance with the selected function</p>	Off	End of list	End of Start		Read/Write
PNU 11910 I/O Digital Outputs Digital Output 4 N/O(44) High Output = 1 When Value	<p>Allows the polarity of the output to be reversed.</p> <p>On: When the selected function is on the output will be on.</p> <p>Off: When the selected function is on the output is off.</p>	Off	On	On		Read/Write
PNU 11588 I/O Digital Outputs Digital Output 5(N/O(54)) Select Function	<p>Allows the Digital output (N/O (54)) to be mapped to different functions.</p> <p>The digital output will change in accordance with the selected function</p>	Off	End of list	End of Start		Read/Write
PNU 11912 I/O Digital Outputs Digital Output 5 N/O(54) High Output = 1 When Value	<p>Allows the polarity of the output to be reversed.</p> <p>On: When the selected function is on the output will be on.</p> <p>Off: When the selected function is on the output is off.</p>	Off	On	On		Read/Write



Operation

5.10 Input/Output Menu (continued)

Menu	Description	Min	Max	Default	Unit	Reg. Type
PNU 9600 I/O Analogue Inputs  Analogue Input Type	Defines the function of the analogue input (AI). 0-10V: The input voltage varies from 0-10V. 4-20mA: The input varies from 4 to 20mA.	0 - 10V	4 - 20mA	0 - 10V		Read/Write
PNU 9664 I/O Analogue Inputs  Select Function	Allows the Analogue input to be mapped to different functions The selected function will change in proportion with the input By default the function will be at its maximum when the input is at its maximum	Off	End of List	Off		Read/Write
PNU 9728 I/O Analogue Inputs  Scaling Level	Allows the selected function to be scaled. The selected function will change in proportion with the input. The function will be at its "Scaling Level" when the input is at its maximum.	0	Max value	Max value	%	Read/Write
PNU 8960 I/O Analogue Outputs  Analogue Output Type	Defines the physical function of the analogue output (AO). 0-10V: The output voltage varies from 0 to 10V. 4-20mA: The output current varies from 4 to 20mA.	0 - 10V	4 - 20mA	0 - 10V		Read/Write
PNU 9024 I/O Analogue Outputs  Select Function	Allows the Analogue output to be mapped to different PNU functions. The output will change in proportion with the selected function. By default, the output will be at a maximum when the selected function equals its maximum value.	Off	End of list	Off		Read/Write

Operation

5.10 Input/Output Menu (continued)

Menu	Description	Min	Max	Default	Unit	Reg. Type
PNU 9088 I/O Analogue Outputs  Scaling Level	<p>Allows the selected function to be scaled.</p> <p>The output will change in proportion with the selected function.</p> <p>The output will be at a maximum when the selected function equals the "Scaling Level".</p>	0	Max value	0	%	Read/Write
PNU 53794 I/O   PTC Motor Thermistor Trip	<p>A single PTC motor thermistor or set of PTC motor thermistors can be connected to the PTC terminals.</p> <p>On: The Unit will trip if the motor thermistor exceeds its response temperature or the PTC input is open circuit.</p> <p>Off: The Unit will continue to operate.</p>	Off	On	Off		Read/Write

Operation

5.11 Monitor Menu

Menu	Description	Min	Max	Default	Unit	Reg. Type
PNU 32000 Monitor ↓ ↓ Line Frequency	The frequency of the 3-phase supply.	45	65	-	Hz	Read Only
PNU 32064 Monitor ↓ ↓ Phase Rotation	Indicates the phase sequence of the incoming supply. RYB = L1-L2-L3. RBY = L1-L3-L2.	L1-L2-L3	L1-L3-L2	L1-L2-L3		Read Only
PNU 33536 Monitor ↓ ↓ I1	The RMS current on phase L1.	0	10000	0	A	Read Only
PNU 33538 Monitor ↓ ↓ I2	The RMS current on phase L2.	0	10000	0	A	Read Only
PNU 33540 Monitor ↓ ↓ I3	The RMS current on phase L3.	0	10000	0	A	Read Only
PNU 32896 Monitor ↓ ↓ Current Irms	The RMS motor current. This is the maximum of the 3 phases. This value is used for the overload and power calculations.	0	10000	0	A	Read Only

Operation

5.11 Monitor Menu (continued)

Menu	Description	Min	Max	Default	Unit	Reg. Type
PNU 33920 Monitor ↓ ↓ V1	The voltage on phase L1	0	1000	0	V	Read Only
PNU 33921 Monitor ↓ ↓ V2	The voltage on phase L2	0	1000	0	V	Read Only
PNU 33922 Monitor ↓ ↓ V3	The voltage on phase L3	0	1000	0	V	Read Only
PNU 32960 Monitor ↓ ↓ Voltage Vrms	<p>The RMS 3-phase supply voltage.</p> <p>This is the average of the 3 phases. This value is used for power calculations.</p> <p>This value is derived internally. If a higher level of accuracy is required a "Fixed Voltage" value can be used.</p>	0	1000	0	V	Read Only
PNU 36544 Monitor ↓ ↓ HeatSink Temp	<p>The temperature of the internal Unit heatsink.</p> <p>The Unit will trip when the heatsink temperature exceeds 90°C.</p> <p>The internal cooling fans will turn on if this temperature exceeds 40°C.</p>	-20	90	0	°C or °F	Read Only

Operation

5.11 Monitor Menu (continued)

<p>PNU 33024 Monitor</p> <p style="text-align: center;">↓ ↓</p> <p>True Power Factor</p>	<p>The True Power Factor = (Displacement Power Factor x Distortion Power Factor)</p>	0	1	0		Read Only
<p>PNU 34688 Monitor</p> <p style="text-align: center;">↓ ↓</p> <p>True Power P</p>	<p>Total true power (Estimated). This is an addition of the 3 phases.</p>	0	10000	0	kW	Read Only
<p>PNU 34816 Monitor</p> <p style="text-align: center;">↓ ↓</p> <p>Apparent Power S</p>	<p>Total Apparent Power This is an addition of the 3 phases.</p>	0	10000	0	kVA	Read Only
<p>PNU 34944 Monitor</p> <p style="text-align: center;">↓ ↓</p> <p>Reactive Power Q</p>	<p>Total Reactive Power This is an addition of the 3 phases.</p>	0	10000	0	kvar	Read Only
<p>PNU 35008 Monitor</p> <p style="text-align: center;">↓ ↓</p> <p>iERS Saving Level</p>	<p>Indicates the level of potential saving. 100% indicates that Unit is saving at its maximum level. Does not indicated real percentage saving.</p>	0	100	0	%	Read Only
<p>PNU 22400 Monitor</p> <p style="text-align: center;">↓ ↓</p> <p>Delay Angle</p>	<p>Internal firing delay angle in Degrees. Displayed for diagnostic purposes.</p>	0	60	0	Deg	Read Only

Operation

5.11 Monitor Menu (continued)

Menu	Description	Min	Max	Default	Unit	Reg. Type
PNU 23040 Monitor ↓ ↓ BackStop	<p>The maximum possible Delay angle for the current iERS saving phase.</p> <p>Displayed for diagnostic purposes.</p> <p>May decrease during heavy load periods or instability.</p>	0	55	0	Deg	Read Only
PNU 22464 Monitor ↓ ↓ Delay Max	<p>The maximum possible delay for iERS saving.</p> <p>Displayed for diagnostic purposes.</p>	0	55	0	Deg	Read Only
PNU 21824 Monitor ↓ ↓ Pres PF Degrees	<p>The Present Power Factor used by the iERS saving function</p> <p>This is the actual Power Factor for the iERS saving function.</p> <p>The "Delay" is constantly adjusted to minimise the control loop error between "Pres PF Degrees" and "Ref PF Degrees"</p> <p>The parameter displays the displacement part of the True Power Factor and is used for diagnostic purposes.</p>	0	90	0	Deg	Read Only
PNU 21760 Monitor ↓ ↓ Ref PF Degrees	<p>The Reference Power Factor used by the iERS saving function</p> <p>This is the target Power Factor for the iERS saving function.</p> <p>The parameter will change dynamically dependant on motor operation</p> <p>The parameter displays the displacement part of the True Power Factor and is used for diagnostic purposes.</p>	0	90	0	Deg	Read Only







Operation

5.11 Monitor Menu (continued)

Menu	Description	Min	Max	Default	Unit	Reg. Type
<p>PNU 21320</p> <p>Monitor</p> <p style="text-align: center;">↓</p> <p style="text-align: center;">↓</p> <p>Start Saving Level</p>	<p>The current in Amps at which the iERS is enabled or disabled.</p> <p>The iERS function is active when the motor current is less than the "Start Saving Level".</p> <p>When the iERS function is disabled internal bypass relays close to improve efficiency.</p>	50% I-motor	80% I-motor	80% I-motor	A	Read Only
<p>PNU 38400</p> <p>Monitor</p> <p style="text-align: center;">↓</p> <p style="text-align: center;">↓</p> <p>Last Peak Current</p>	<p>Displays the peak current of the last successful start.</p>	0	10000	0	A	Read Only
<p>PNU 10432</p> <p>Monitor</p> <p style="text-align: center;">↓</p> <p style="text-align: center;">↓</p> <p>Motor Thermistor</p>	<p>Indicates the state of the Unit PTC input. Designed for single or double or triple PTC in series</p> <p>PTC thermistor standards DIN44081 / EN60738-1 apply (< 300R @ 25°C. Typically 4K @ nominal temperature)</p> <p>The value indicated is a not in degrees Celsius but is an internal representation.</p> <p>At 25°C the value displayed should be less than 100 and the Unit trips when value > 400 (open circuit = 1024)</p> <p>The value will increase rapidly when the motor thermistors approach their nominal temperature.</p> <p>If thermistors are connected the "Thermistor trip" should be turned "on"</p>	0	1024	1024		Read Only

Operation

5.11 Monitor Menu (continued)

Menu	Description	Min	Max	Default	Unit	Reg. Type
PNU 33408 Monitor   Overload	<p>The Unit has an "Overload" function that is an electronic equivalent to a thermal overload.</p> <p>"Overload" displays the overload level which is a measure of how close the Unit to tripping on "Overload Trip"</p> <p>When "Current Irms" is greater than the "Overload Level" the "Overload" increases in accordance with the "Trip Class".</p> <p>When "Current Irms" is less than "Overload Level" the "Overload" decreases exponentially (if greater than 50%)</p> <p>When the "Overload" reaches 100% the Unit will trip.</p> <p>During situations when (i-motor) is equal to (i-Unit) the overload will indicate 50%</p>	0	100	0	%	Read Only
PNU 37376 Monitor   Auto Reset Pending	<p>Indicates that the Reset Delay counter is counting down.</p> <p>Yes: The Auto Reset Delay is counting down.</p> <p>No: The Auto Reset Delay is not counting down.</p> <p>To map to digital output, refer to PNU11584-PNU11587.</p>	No	Yes	No		Read Only
PNU 37568 Monitor   Auto Reset Exceeded	<p>Indicates that the maximum number of reset attempts has been reached.</p> <p>Yes: The number of reset attempts has exceeded the value set.</p> <p>No: The number of reset attempts has not exceeded the value set".</p> <p>To map to digital output, refer to PNU11584-PNU11587.</p>	No	Yes	No		Read Only

Operation

5.11 Monitor Menu (continued)

Menu	Description	Min	Max	Default	Unit	Reg. Type
PNU 20864 Monitor ↓ ↓ Reset Delay	The amount of time remaining in the Reset Delay counter.	0	7200	0	s	Read Only
PNU 20865 Monitor ↓ ↓ Reset Attempts	The number of Reset Attempts remaining.	0	10	0		Read Only
PNU 20866 Monitor ↓ ↓ Trip Free Time	This is the amount of time remaining in the Trip Free Time counter.	0	7200	600	A	Read Only
PNU 20867 Monitor ↓ ↓ Trip Event	This is the trip that occurred just prior to the auto reset.	100	2700	0		Read Only

Operation

5.11 Monitor Menu (continued)

Menu	Description	Min	Max	Default	Unit	Reg. Type
<p style="text-align: center;"> PNU 33409 Monitor  Dynamic Reset </p>	<p>Dynamically tracks the thermal capacity needed for a successful restart after an overload trip. It averages the thermal capacity consumed in the previous three successful starts and calculates a thermal capacity to start.</p> <p>The calculated thermal capacity is stored in the "Dynamic Reset" register. After tripping on overload, the thermal "Overload" register must have regained the amount recorded in "Dynamic Reset" before a reset will be allowed.</p> <p>If there is insufficient capacity to start the unit it will be inhibited from starting. The unit can be reset when there is sufficient capacity to start and the start stop signal is not present.</p>	0	100	0	%	Read Only

Operation

5.12 Log Menu

Menu	Description	Min	Max	Default	Unit	Reg. Type
PNU 60608 Log Trip Log ↓ Last Trip	Displays the last Fault trip.	0	65535	0		Read Only
PNU 60609 Log Trip Log ↓ Last Trip -1	Displays the last Fault trip - 1.	0	65535	0		Read Only
PNU 60610 Log Trip Log ↓ Last Trip -2	Displays the last Fault trip - 2.	0	65535	0		Read Only
PNU 60611 Log Trip Log ↓ Last Trip -3	Displays the last Fault trip - 3.	0	65535	0		Read Only
PNU 60612 Log Trip Log ↓ Last Trip -4	Displays the last Fault trip - 4.	0	65535	0		Read Only
PNU 60613 Log Trip Log ↓ Last Trip -5	Displays the last Fault trip - 5.	0	65535	0		Read Only

Operation

5.12 Log Menu (continued)

Menu	Description	Min	Max	Default	Unit	Reg. Type
PNU 60614 Log Trip Log ↓ Last Trip -6	Displays the last Fault trip – 6.	0	65535	0		Read Only
PNU 60615 Log Trip Log ↓ Last Trip -7	Displays the last Fault trip – 7.	0	65535	0		Read Only
PNU 60616 Log Trip Log ↓ Last Trip -8	Displays the last Fault trip – 8.	0	65535	0		Read Only
PNU 60617 Log Trip Log ↓ Last Trip -9	Displays the last Fault trip -9.	0	65535	0		Read Only
PNU - Log Trip Log Trip Code Descriptions 101 Input Side Phase Loss	Phase L1 missing at the instant of start up. The L1 phase is either missing or at a very low level. Check all incoming connections. If a main contactor is being controlled by a digital output set to "Running", check contactor delay is sufficient.					Read Only

Operation

5.12 Log Menu (continued)

Menu	Description	Min	Max	Default	Unit	Reg. Type
<p>PNU - Log Trip Log Trip Code Descriptions 102 Input Side Phase Loss</p>	<p>Phase L2 missing at the instant of start up.</p> <p>The L2 phase is either missing or at a very low level.</p> <p>Check all incoming connections.</p> <p>If a main contactor is being controlled by a digital output set to "Running", check contactor delay is sufficient.</p>					Read Only
<p>PNU - Log Trip Log Trip Code Descriptions 103 Input Side Phase Loss</p>	<p>Phase L3 missing at the instant of start up.</p> <p>The L3 phase is either missing or at a very low level.</p> <p>Check all incoming connections.</p> <p>If a main contactor is being controlled by a digital output set to "Running" check contactor delay is sufficient.</p>					Read Only
<p>PNU - Log Trip Log Trip Code Descriptions 104 – 117 Input Side Phase Loss</p>	<p>Any or all phases missing when the motor is being controlled.</p> <p>L1 L2 or L3 phase are missing or at a very low level.</p> <p>Check all incoming connections.</p> <p>Check any fuses/breakers incorporated in the power circuit.</p>					Read Only
<p>PNU - Log Trip Log Trip Code Descriptions 150 Voltage Imbalance</p>	<p>The three phase input voltages are imbalanced</p> <p>The maximum voltage is determined and the other voltages are compared to it.</p> <p>Check all incoming connections.</p> <p>Check any fuses / breakers incorporated in the power circuit</p>					Read Only

Operation

5.12 Log Menu (continued)

Menu	Description	Min	Max	Default	Unit	Reg. Type
<p>PNU - Log Trip Log Trip Code Descriptions 201 Max. Temp. Exceeded</p>	<p>Internal heatsink temperature has exceeded 90°C.</p> <p>It is possible the Unit is operating outside specified limits.</p> <p>Check enclosure ventilation and airflow around the Unit. If the unit trips immediately the internal temperature sensor could be faulty.</p>					Read Only
<p>PNU - Log Trip Log Trip Code Descriptions 208 Thermal Sensor Trip</p>	<p>Thermal sensor Failure.</p> <p>The internal temperature sensor has failed.</p> <p>Contact the supplier.</p>					Read Only
<p>PNU - Log Trip Log Trip Code Descriptions 301-308 Thyristor Firing Trip</p>	<p>One or more of the internal control thyristors (SCRs) have failed to turn on properly. (In-Line "Firing Mode").</p> <p>The Unit has detected that the SCRs are not operating as expected.</p> <p>Check all incoming and outgoing connections.</p>					Read Only
<p>PNU - Log Trip Log Trip Code Descriptions 350-358 Thyristor Firing Trip</p>	<p>One or more of the internal control thyristors (SCRs) have failed to turn on properly. (Delta "Firing Mode").</p> <p>The Unit has detected that the SCRs are not operating as expected.</p> <p>Check all incoming and outgoing connections.</p>					Read Only

Operation

5.12 Log Menu (continued)

Menu	Description	Min	Max	Default	Unit	Reg. Type
<p>PNU - Log Trip Log Trip Code Descriptions 401 Motor Side Phase Loss</p>	<p>One or all of the phases are missing on the motor side during the instant of start up.</p> <p>T1 T2 or T3 phase are missing or at a very low level.</p> <p>Check that the motor is connected to T1 T2 and T3. Ensure any disconnecting device between the Unit and the motor is closed at the instant of start.</p>					Read Only
<p>PNU - Log Trip Log Trip Code Descriptions 402-403 Motor Side Phase Loss</p>	<p>One or all of the phases are missing on the motor side during the instant of start up when the motor being controlled.</p> <p>T1 T2 or T3 phase are missing or at a very low level.</p> <p>Check all incoming and outgoing connections.</p>					Read Only
<p>PNU - Log Trip Log Trip Code Descriptions 601 Control Voltage Too Low</p>	<p>The internal control supply of the Unit level has fallen to a low level.</p> <p>Can be caused by a weak 24Vdc control supply.</p> <p>Ensure 24Vdc supply meets the requirements specified in the Quick Start Guide.</p>					Read Only
<p>PNU - Log Trip Log Trip Code Descriptions 701-710 Sensing Fault Trip</p>	<p>One or more of the internal control thyristors (SCRs) have failed to turn on properly.</p> <p>The Unit has detected that the SCRs are not operating as expected.</p> <p>Check connections all incoming and outgoing connections.</p>					Read Only
<p>PNU - Log Trip Log Trip Code Descriptions 801-802 Fan Problem</p>	<p>One or more of the internal cooling fans has failed.</p> <p>To ensure the heatsink is cooled sufficiently the Unit will trip if the fans fail to operate.</p> <p>Check Unit fans for signs of damage or contamination.</p>					Read Only

Operation

5.12 Log Menu (continued)

<p>PNU - Log Trip Log Trip Code Descriptions 1001 Short Circuit Thyristor</p>	<p>One or more of the internal control thyristors (SCRs) have failed short circuit.</p> <p>The Unit has detected that the SCRs are not operating as expected.</p> <p>ISOLATE SUPPLY + MOTOR Disconnect supply. Check by measuring the resistance between L1-T1 L2-T2 L3-T3 (Anything < 10R is assumed short circuit).</p>					Read Only
<p>PNU - Log Trip Log Trip Code Descriptions 1101 Low Current Trip</p>	<p>The motor current has been lower than the low trip level for the low trip time.</p> <p>This trip is not active during soft start and soft stop and is "off" by default.</p> <p>If the low current trip is not required turn "off" in "Trip Settings".</p>					Read Only
<p>PNU - Log Trip Log Trip Code Descriptions 1201 Current Limit Timeout Trip</p>	<p>The motor has been held in current limit longer than the "Start current limit Time".</p> <p>It is likely that the current limit level has been set too low for the application.</p> <p>Increase the current limit level or timeout period.</p>					Read Only
<p>PNU - Log Trip Log Trip Code Descriptions 1202 Current Limit Timeout Trip</p>	<p>The motor has been held in current limit longer than the "Stop current limit Time".</p> <p>It is likely that the current limit level has been set too low for the application.</p> <p>Increase the current limit level or timeout period.</p>					Read Only
<p>PNU - Log Trip Log Trip Code Descriptions 1301 Overload Trip</p>	<p>The "Overload" has exceeded 100%.</p> <p>The Unit is attempting to start an application that is outside its capacity or it is starting too often.</p> <p>Refer to the overload trip curves to determine whether the Unit has been sized correctly.</p>					Read Only

Operation

5.12 Log Menu (continued)

Menu	Description	Min	Max	Default	Unit	Reg. Type
<p>PNU - Log Trip Log Trip Code Descriptions 1302 Overload Trip</p>	<p>The motor current has exceeded 475% (i-Unit) for a time greater than 250ms.</p> <p>The Unit is attempting to start an application that is outside its capacity with a "high current limit level" set.</p> <p>Refer to the overload trip curves to determine whether the Unit has been sized correctly and check current limit level.</p>					Read Only
<p>PNU - Log Trip Log Trip Code Descriptions 1401 Shearpin Trip</p>	<p>The motor current has been higher than the "Shearpin Trip Level" for the trip time.</p> <p>This trip is not active during soft start and soft stop and is "off" by default.</p> <p>If Shearpin trip is not required turn "off" in "Trip Settings".</p>					Read Only
<p>PNU - Log Trip Log Trip Code Descriptions 1501 PTC Thermistor Trip</p>	<p>The PTC thermistor value has exceeded the trip level.</p> <p>The PTC thermistor connected to the PTC input has exceeded its response temperature or the PTC input is open circuit.</p> <p>If the PTC TRIP is not required turn "off" in "Trip Settings".</p>					Read Only
<p>PNU - Log Trip Log Trip Code Descriptions 1601 External Trip</p>	<p>External Trip.</p> <p>The input programmed to External Trip is active.</p> <p>If the External trip is not required turn "off" in "Trip settings".</p>					Read Only
<p>PNU - Log Trip Log Trip Code Descriptions 1701 Communications Trip</p>	<p>Modbus RTU Communications failure</p> <p>The command or status PNU has not been polled in the time set in the "Timeout" period.</p> <p>If the communication trip is disabled, the Unit cannot be stopped in the communications fail.</p>					Read Only

Operation

5.12 Log Menu (continued)

Menu	Description	Min	Max	Default	Unit	Reg. Type
<p>PNU - Log Trip Log Trip Code Descriptions 1702 Communications Trip</p>	<p>Modbus TCP Communications failure</p> <p>The command or status PNU has not been polled in the time set in the "Timeout" period.</p> <p>If the communication trip is disabled, the Unit cannot be stopped in the communications fail.</p>					Read Only
<p>PNU - Log Trip Log Trip Code Descriptions 1703 Communications Trip</p>	<p>Anybus Communications failure</p> <p>The command or status PNU has not been polled in the time set in the "Timeout" period.</p> <p>If the communication trip is disabled, the Unit cannot be stopped in the communications fail.</p>					Read Only
<p>PNU - Log Trip Log Trip Code Descriptions 1704 Communications Trip</p>	<p>Keypad Communications failure</p> <p>The communications bus has failed or become inactive between the keypad and the main unit.</p> <p>If the communication trip is disabled, the Unit cannot be stopped in the communications fail.</p>					Read Only
<p>PNU - Log Trip Log Trip Code Descriptions 1801-1802 Bypass Relay Trip</p>	<p>One or more of the internal bypass relays has failed to close.</p> <p>The internal bypass relay has failed, or the control supply is too weak.</p> <p>Ensure 24Vdc supply meets the requirements specified in the Quick Start Guide.</p>					Read Only
<p>PNU - Log Trip Log Trip Code Descriptions 1803 Bypass Relay Trip</p>	<p>One or more of the internal bypass relays has failed to open.</p> <p>The internal bypass relay has failed, or the control supply is too weak.</p> <p>Ensure 24Vdc supply meets the requirements specified in the Quick Start Guide.</p>					Read Only

Operation

5.12 Log Menu (continued)

Menu	Description	Min	Max	Default	Unit	Reg. Type
PNU - Log Trip Log Trip Code Descriptions 2001-2003 Remote Start is Enabled	<p>The remote start signal is active.</p> <p>The remote start signal was active during power up or Reset or Parameter Load.</p> <p>Turn off remote or if Remote On trip is not required turn "off" in "Trip Settings".</p>					Read Only
PNU - Log Trip Log Trip Code Descriptions 2101 Rotation L1 L2 L3 Trip	<p>The input phase rotation is RYB (L1-L2-L3).</p> <p>The phase rotation is opposite to that required.</p> <p>Change phase rotation or if "RYB" trip is not required turn "off" in trip settings.</p>					Read Only
PNU - Log Trip Log Trip Code Descriptions 2102 Rotation L1 L3 L2 Trip	<p>The input phase rotation is RBY (L1-L3-L2).</p> <p>The phase rotation is opposite to that required.</p> <p>Change phase rotation or if "RBY" trip is not required turn "off" in trip settings.</p>					Read Only
PNU - Log Trip Log Trip Code Descriptions 2201-2299 MPU Trip	<p>Internal Unit Failure.</p> <p>The Unit has failed internally and is unable to recover automatically.</p> <p>Cycle the control supply.</p> <p>If the fault is not cleared, then contact the supplier.</p>					Read Only
PNU - Log Trip Log Trip Code Descriptions 2301-2303 Current Sensor Trip	<p>Current sensor failure.</p> <p>One or more of the internal sensors used to measure current has failed or is reading a low value.</p> <p>Check the connections to the supply and motor as disconnection will result in a zero current reading.</p> <p>Check the plate FLA of the motor being controlled is at least 25% of the "i-motor" rating.</p>					Read Only

Operation

5.12 Log Menu (continued)

Menu	Description	Min	Max	Default	Unit	Reg. Type
<p>PNU - Log Trip Log Trip Code Descriptions 2401-2499 Operation 2 Trip</p>	<p>Fail Safe operation (Operation 2)</p> <p>A process associated with the Main micro controller has been affected and is unable to recover automatically</p> <p>The trip MUST be reset by either the digital input or keypad or the bus command depending on the control method set.</p> <p>This trip is a special case and it is NOT possible to reset this trip by cycling the control supply</p>					Read Only
<p>PNU - Log Trip Log Trip Code Descriptions 2601-2699 Operation 1 Trip</p>	<p>Fail Safe operation (Operation 1)</p> <p>A process associated with the Logging function has been affected and is unable to recover automatically</p> <p>The trip can be reset by either the digital input or keypad or the bus command depending on the control method set.</p> <p>It is also possible to reset this trip by cycling the control supply</p>					Read Only
<p>PNU - Log Trip Log Trip Code Descriptions 2701-2799 MPU Trip</p>	<p>Internal Unit Failure (MPU / Operation 5)</p> <p>The Unit has failed internally and is unable to recover automatically.</p> <p>Cycle the control supply.</p> <p>If the fault is not cleared then contact the supplier</p>					Read Only
<p>PNU 38400 Log Trip Log ↓ Last Peak Current</p>	<p>Displays the peak current of the last successful start.</p>	0	10000	0	A	Read Only

Operation

5.12 Log Menu (continued)

Menu	Description	Min	Max	Default	Unit	Reg. Type
PNU 38402 Log Trip Log ↓ Last peak start current -1	Displays the peak current of the last successful start -1.	0	10000	0	A	Read Only
PNU 38404 Log Trip Log ↓ Last peak start current -2	Displays the peak current of the last successful start -2.	0	10000	0	A	Read Only
PNU 38406 Log Trip Log ↓ Last peak start current -3	Displays the peak current of the last successful start -3.	0	10000	0	A	Read Only
PNU 38408 Log Trip Log ↓ Last peak start current -4	Displays the peak current of the last successful start -4.	0	10000	0	A	Read Only
PNU 38410 Log Trip Log ↓ Last peak start current -5	Displays the peak current of the last successful start -5.	0	10000	0	A	Read Only

Operation

5.12 Log Menu (continued)

Menu	Description	Min	Max	Default	Unit	Reg. Type
PNU 38412 Log Trip Log ↓ Last peak start current -6	Displays the peak current of the last successful start -6.	0	10000	0	A	Read Only
PNU 38414 Log Trip Log ↓ Last peak start current -7	Displays the peak current of the last successful start -7.	0	10000	0	A	Read Only
PNU 38416 Log Trip Log ↓ Last peak start current -8	Displays the peak current of the last successful start -8.	0	10000	0	A	Read Only
PNU 38418 Log Trip Log ↓ Last peak start current -9	Displays the peak current of the last successful start -9.	0	10000	0	A	Read Only
PNU 39040 Log Trip Log ↓ Last peak stop current	Displays the peak current of the last successful stop.	0	10000	0	A	Read Only

Operation

5.12 Log Menu (continued)

Menu	Description	Min	Max	Default	Unit	Reg. Type
PNU 39042 Log Trip Log ↓ Last peak stop current -1	Displays the peak current of the last successful stop -1.	0	10000	0	A	Read Only
PNU 39044 Log Trip Log ↓ Last peak stop current -2	Displays the peak current of the last successful stop -2.	0	10000	0	A	Read Only
PNU 39046 Log Trip Log ↓ Last peak stop current -3	Displays the peak current of the last successful stop -3.	0	10000	0	A	Read Only
PNU 39048 Log Trip Log ↓ Last peak stop current -4	Displays the peak current of the last successful stop -4.	0	10000	0	A	Read Only
PNU 39050 Log Trip Log ↓ Last peak stop current -5	Displays the peak current of the last successful stop -5.	0	10000	0	A	Read Only







Operation

5.12 Log Menu (continued)

Menu	Description	Min	Max	Default	Unit	Reg. Type
PNU 39052 Log Trip Log ↓ Last peak stop current -6	Displays the peak current of the last successful stop -6.	0	10000	0	A	Read Only
PNU 39054 Log Trip Log ↓ Last peak stop current -7	Displays the peak current of the last successful stop -7.	0	10000	0	A	Read Only
PNU 39056 Log Trip Log ↓ Last peak stop current -8	Displays the peak current of the last successful stop -8.	0	10000	0	A	Read Only
PNU 39058 Log Trip Log ↓ Last peak stop current -9	Displays the peak current of the last successful stop -9.	0	10000	0	A	Read Only
PNU 39680 Log Trip Log ↓ Last temperature	Displays the heatsink temperature at the end of the last successful start.	-20	80		°C	Read Only







Operation

5.12 Log Menu (continued)

Menu	Description	Min	Max	Default	Unit	Reg. Type
PNU 39681 Log Trip Log  Last temperature -1	Displays the heatsink temperature at the end of the last successful start -1.	-20	80		°C	Read Only
PNU 39682 Log Trip Log  Last temperature -2	Displays the heatsink temperature at the end of the last successful start -2.	-20	80		°C	Read Only
PNU 39683 Log Trip Log  Last temperature -3	Displays the heatsink temperature at the end of the last successful start-3.	-20	80		°C	Read Only
PNU 39684 Log Trip Log  Last temperature -4	Displays the heatsink temperature at the end of the last successful start-4.	-20	80		°C	Read Only
PNU 39685 Log Trip Log  Last temperature -5	Displays the heatsink temperature at the end of the last successful start-5.	-20	80		°C	Read Only
PNU 39686 Log Trip Log  Last temperature -6	Displays the heatsink temperature at the end of the last successful start-6.	-20	80		°C	Read Only







Operation

5.12 Log Menu (continued)

Menu	Description	Min	Max	Default	Unit	Reg. Type
PNU 39687 Log Trip Log  Last temperature -7	Displays the heatsink temperature at the end of the last successful start-7.	-20	80		°C	Read Only
PNU 39688 Log Trip Log  Last temperature -8	Displays the heatsink temperature at the end of the last successful start-8.	-20	80		°C	Read Only
PNU 39689 Log Trip Log  Last temperature -9	Displays the heatsink temperature at the end of the last successful start-9.	-20	80		°C	Read Only
PNU 40320 Log Trip Log  Last overload	Displays the overload level at the end of the last successful start.	0	100	0	%	Read Only
PNU 40321 Log Trip Log  Last overload-1	Displays the overload level at the end of the last successful start -1.	0	100	0	%	Read Only
PNU 40322 Log Trip Log  Last overload-2	Displays the overload level at the end of the last successful start -2.	0	100	0	%	Read Only

Operation

5.12 Log Menu (continued)

Menu	Description	Min	Max	Default	Unit	Reg. Type
PNU 40323 Log Trip Log  Last overload-3	Displays the overload level at the end of the last successful start -3.	0	100	0	%	Read Only
PNU 40324 Log Trip Log  Last overload-4	Displays the overload level at the end of the last successful start -4.	0	100	0	%	Read Only
PNU 40325 Log Trip Log  Last overload-5	Displays the overload level at the end of the last successful start -5.	0	100	0	%	Read Only
PNU 40326 Log Trip Log  Last overload-6	Displays the overload level at the end of the last successful start -6.	0	100	0	%	Read Only
PNU 40327 Log Trip Log  Last overload-7	Displays the overload level at the end of the last successful start -7.	0	100	0	%	Read Only
PNU 40328 Log Trip Log  Last overload-8	Displays the overload level at the end of the last successful start -8.	0	100	0	%	Read Only













Operation

5.12 Log Menu (continued)

Menu	Description	Min	Max	Default	Unit	Reg. Type
PNU 40329 Log Trip Log ↓ Last overload-9	Displays the overload level at the end of the last successful start -9.	0	100	0	%	Read Only
PNU 35840 Log Totals Log ↓ Number of Starts	The total number of successful starts.	0	4294836225	0		Read Only
PNU 35904 Log Totals Log ↓ Motor Running Time	The total time the motor has been running.	0	4294836225	0	s	Read Only
PNU 35906 Log Totals Log ↓ Control Supply On Time	The total time the Unit has been powered up.	0	4294836225	0	s	Read Only
PNU - Log ↓ ↓ Download Log File	Download the full log file on to the USB stick. The Unit logs several parameters during normal and fault conditions. Data is stored in CSV format. Please send all downloaded files on request					Read/Write
PNU 62081 Log ↓ ↓ Clear Trip Log	Deletes all of the history in the Trip Log.	No	Yes	No		Read/Write

Operation

5.13 Device Menu

Menu	Description	Min	Max	Default	Unit	Reg. Type
PNU - Device   Update Firmware	<p>Used to upgrade to the latest version of software using a USB stick</p> <p>Details for the upgrading process are supplied with the updated version of software</p>					Read/Write
PNU - Device   Date	<p>Enter current date.</p> <p>Date format can be set to either dd/mm/yyyy or mm/dd/yyyy. Refer to "Date format" parameter.</p>					Read/Write
PNU 14720 Device   Time	<p>Allows the time to be changed to 'local' time.</p> <p>By default, the time is set to GMT.</p>	hh:mm:ss	hh:mm:ss	GMT time	hh:mm:ss	Read/Write
PNU - Device   Language	<p>Selects the display language for the keypad</p> <p>Enter the required language from the displayed list</p>	0	End of List	0		Read/Write
PNU - Device   Passcode	<p>Stops unauthorised access to read/ write parameters.</p> <p>For the passcode be active the "Screen lock" must be turned on.</p>	0	Max Value	0		Read/Write
PNU - Device   Backlight Timeout	<p>Time for backlight on display</p> <p>After the period set the back light on the screen will turn off</p> <p>To reactivate touch screen anywhere. To disable set to 0</p>	0	3600	60	s	Read/Write









Operation

5.13 Device Menu (continued)

Menu	Description	Min	Max	Default	Unit	Reg. Type
PNU 16000 Device Networks Modbus Network Settings Address	Sets the Modbus station number	1	32	1		Read/Write
PNU 16064 Device Networks Modbus Network Settings Baud Rate	Sets the serial communications baud rate. The available baud rates are 9600 19200 38400 57600 or 115200.	9600	115200	19200		Read/Write
PNU 16128 Device Networks Modbus Network Settings Parity	Sets the serial communications parity bit. The available parity options are None Even Odd. Also sets the stop bits. No parity uses 2 stop bits. Odd or even parity uses 1 stop bit.	None	Odd	Even		Read/Write
PNU 14080 Device Networks Modbus Network Settings Traffic LEDS	Allows the user to check the state of the modbus communication network. Red LED receive. Green LED Transmit. On: The Red and Green LEDS display the traffic on the Modbus communications network. Off: The Red and Green LEDs display the Unit status information.	Off	On	Off		Read/Write
PNU - Device Networks  Anybus	Anybus expansion module. Only active with Anybus module fitted.					Read Only











Operation

5.13 Device Menu (continued)

Menu	Description	Min	Max	Default	Unit	Reg. Type
PNU 15808 Device Networks  Timeout ms	<p>Communications trip Timeout period.</p> <p>To prevent a 'Communications Trip' (If enabled) the bus must be kept active.</p> <p>To keep the bus active there must be at least one Modbus read or write (any PNU) during the "Timeout ms" period.</p>	0	60000	5000	ms	Read/Write
PNU 53802 Device Networks  Communications Shutdown	<p>This works in conjunction with the 'Communications Trip'.</p> <p>On: If the 'Communication Trip' is turned 'On' the unit will shut down instead of tripping if the communications fail.</p> <p>Off: If the 'Communication Trip' is turned 'On' the unit will trip if the communications fail.</p>	Off	On	Off		Read/Write
PNU 62080 Device   Reset Defaults	Restores the Unit to the factory defaults.	No	Yes	No		Read/Write
PNU - Device   About	<p>Gives the Model number. Serial Number and current software versions.</p> <p>The software versions are SGY1xxxxxx SGY2xxxxxx and SGY3xxxxxx.</p>					Read Only
PNU - Device   Screen Lock	Stops unauthorised access to read/ write parameters.	Off	On	Off		Read/Write

Operation

5.13 Device Menu (continued)

Menu	Description	Min	Max	Default	Unit	Reg. Type
PNU - Device   Date Format	Allows the date format to be changed dd/mm/yyyy or mm/dd/yyyy.	dd/mm/yyyy	mm/dd/yyyy	dd/mm/yyyy		Read/Write
PNU - Device   Temperature Format	Selects °C or °F for displayed temperatures. °C: All displayed temperatures are °C. °F: All displayed temperatures are °F.	°C	°F	°C		Read/Write
PNU - Device   Parameters to USB	Allows the user to save parameters. Downloads the parameters from the Unit to the USB drive. Data is stored in CSV format.	No	Yes	No		Read/Write
PNU - Device   Parameters from USB	Allows the user to load parameters stored on a USB flash drive. Uploads the parameters from the USB drive to the Unit. Data is stored in CSV format.	No	Yes	No		Read/Write
PNU - 53765 Device   Keypad Trip	Detects if the communications bus has failed or become inactive between the keypad and the main unit. On :Keypad trip enabled. Off : Keypad trip disabled.	Off	On	On		Read/Write

Operation

5.13 Device Menu (continued)

Menu	Description	Min	Max	Default	Unit	Reg. Type
PNU 15809 Device ↓ ↓ Timeout ms	Keypad Communications trip Timeout period When enabled the unit will trip if there is a loss of communication greater than the "Timeout ms" period	0	60000	50000	ms	Read/Write
PNU 13120 Device ↓ ↓ Service Code	Diagnostic parameter. For Internal use only.					

Operation

5.14 Functional Summaries

5.14.1 Automatic Settings

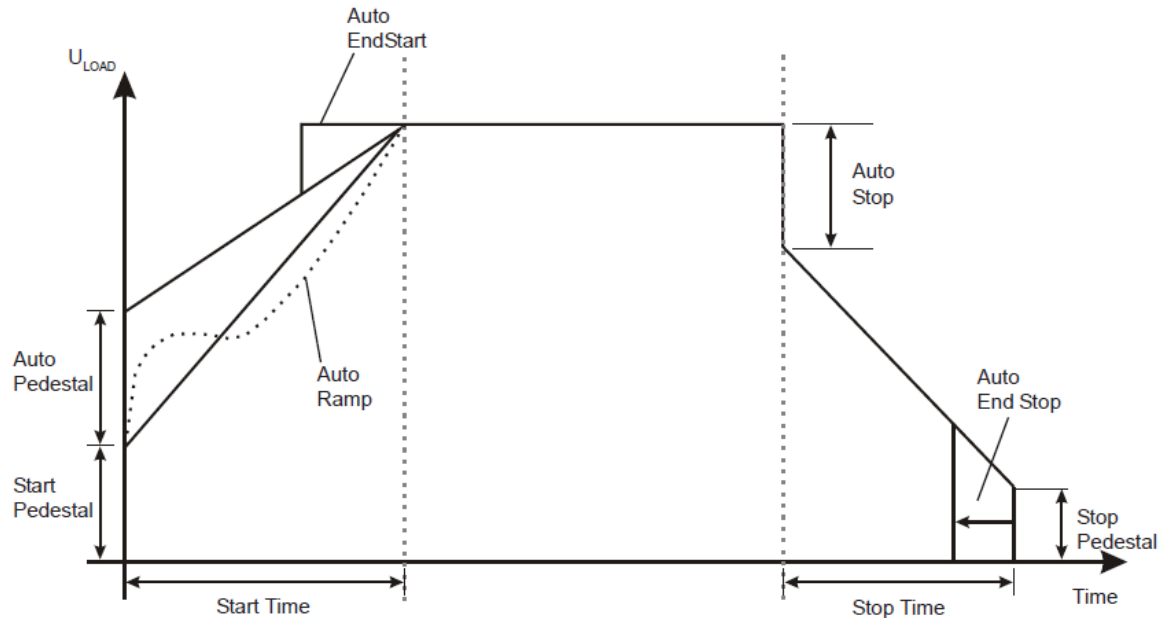

Automatic Pedestal - Automatic overriding of the start pedestal. When On the unit approximately detects the start of motor rotation and tries to adjust the pedestal to suit..

Automatic End Start - Automatic detection of motor full speed during the start-up. Having detected motor full speed achieved before the end of the programmed ramp, this menu item brings forward the end of the ramp cutting short an overlong programmed start.

Automatic Ramp - Automatically detects motor acceleration and dynamically adjusts the ramp to give smoother acceleration. This menu item works in conjunction with the Start Time parameter which should be set to the estimated start time of the load. This would be suitable for starts with varying loads.

Automatic Stop - Automatic adjustment of the soft stop. When On the unit attempts to automatically adjust the soft stop profile to suit the load.

Automatic End Stop - Automatic detection of a stalled motor during soft stop. When On and the motor has stopped before the end of the unit's programmed soft stop the unit will attempt to detect the stall and turn off the thyristors thus truncating the soft stop time.

Auto End Stop - Automatic detection of a stalled motor during soft stop. When On and the motor has stopped before the end of the unit's programmed soft stop the unit will attempt to detect the stall and turn off the thyristors thus truncating the soft stop time.

Operation

5.14 Functional Summaries (continued)

5.14.2 Low Current Protection

A Low Current trip occurs when the current output measured by the unit falls below the level specified by the Low amps level parameter for a length of time specified by the Low Amps Time parameter

1. I_{LOW} = Low Amps Level.
2. If I_{LOAD} drops below 'Low Amps Level' and 'Low Current' is set to 'on', and 'Low Amps Time' is set to minimum then the unit will trip as indicated by the short thick dotted line.
3. If 'Low Amps Time' is set to maximum and I_{LOAD} rises above 'Low Amps Level' before 'Low Amps Time' has elapsed then the unit will not trip.

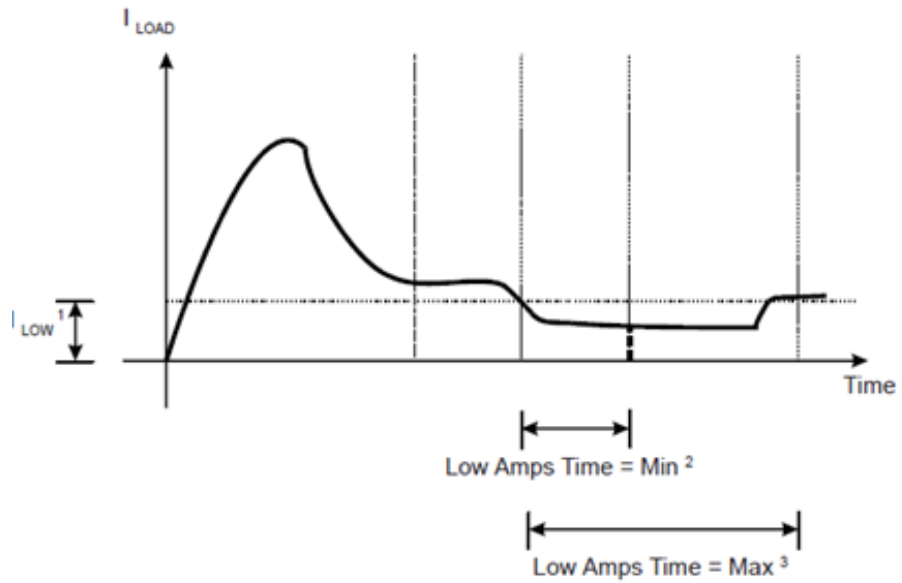

5.14.3 Current Limit

1. If I_{LOAD} exceeds 'Current Limit Level' for time 'Limit Time Out' and 'C/L Time Out' is on, the unit will trip at the thick dotted line. If 'C/L Time Out' is off the unit will continue ramping until T.O.R. and then enter the Dwell period.
2. If the unit current limits during start-up the start time will be elongated by the amount of time that the unit was current limiting.
3. The actual current rises slightly above the level set in 'Current Limit' because the unit manages the current through control of the thyristor firing delay angle.

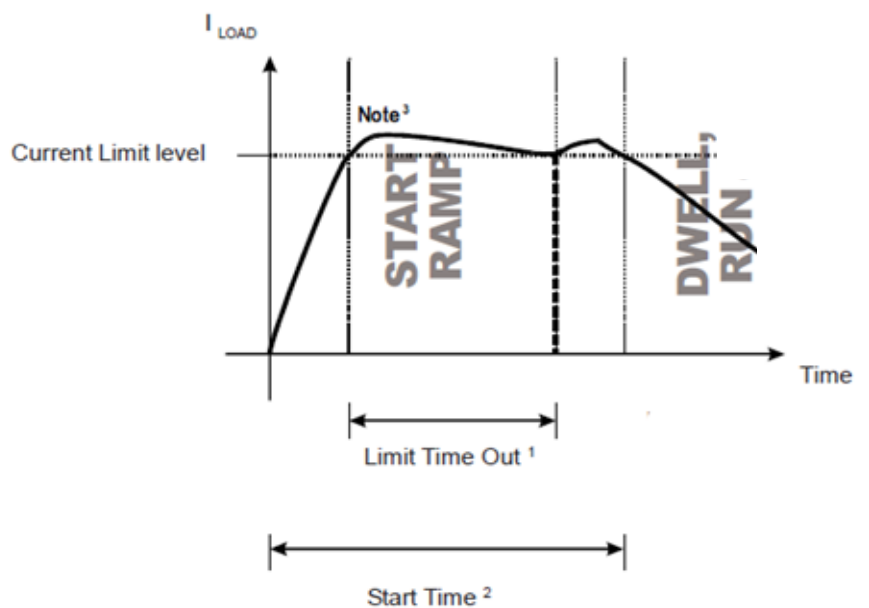

Operation

5.14.4 Shearpin

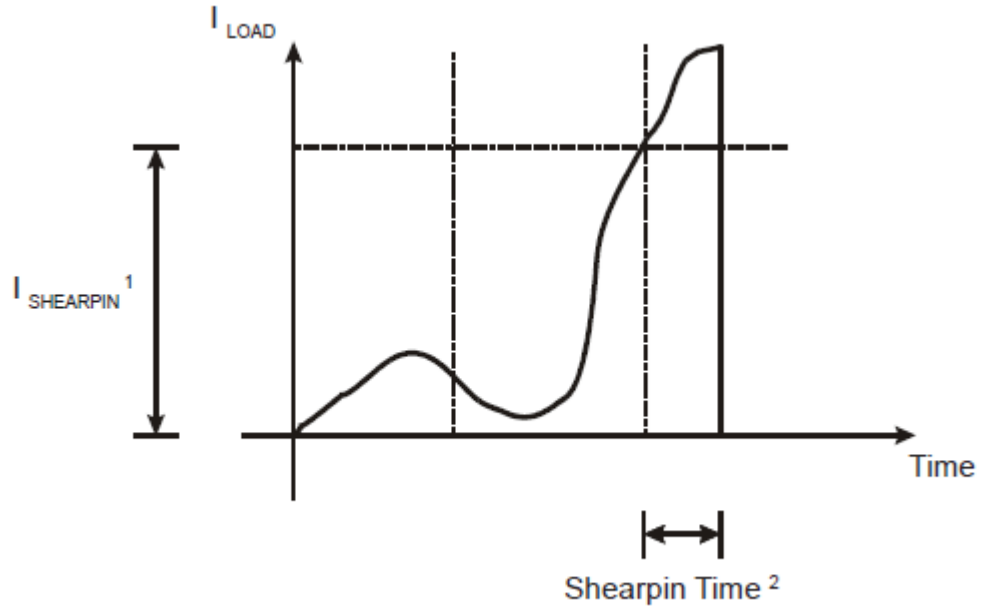

1. $I_{SHEARPIN}$ = Shearpin Level.

2. If I_{LOAD} exceeds $I_{SHEARPIN}$ for a time equal to 'Shearpin Time', and 'Shearpin' is set to 'on', then the unit will trip

Operation

5.15 Touchscreen Menu Paths

5.15.1 Advanced Menu

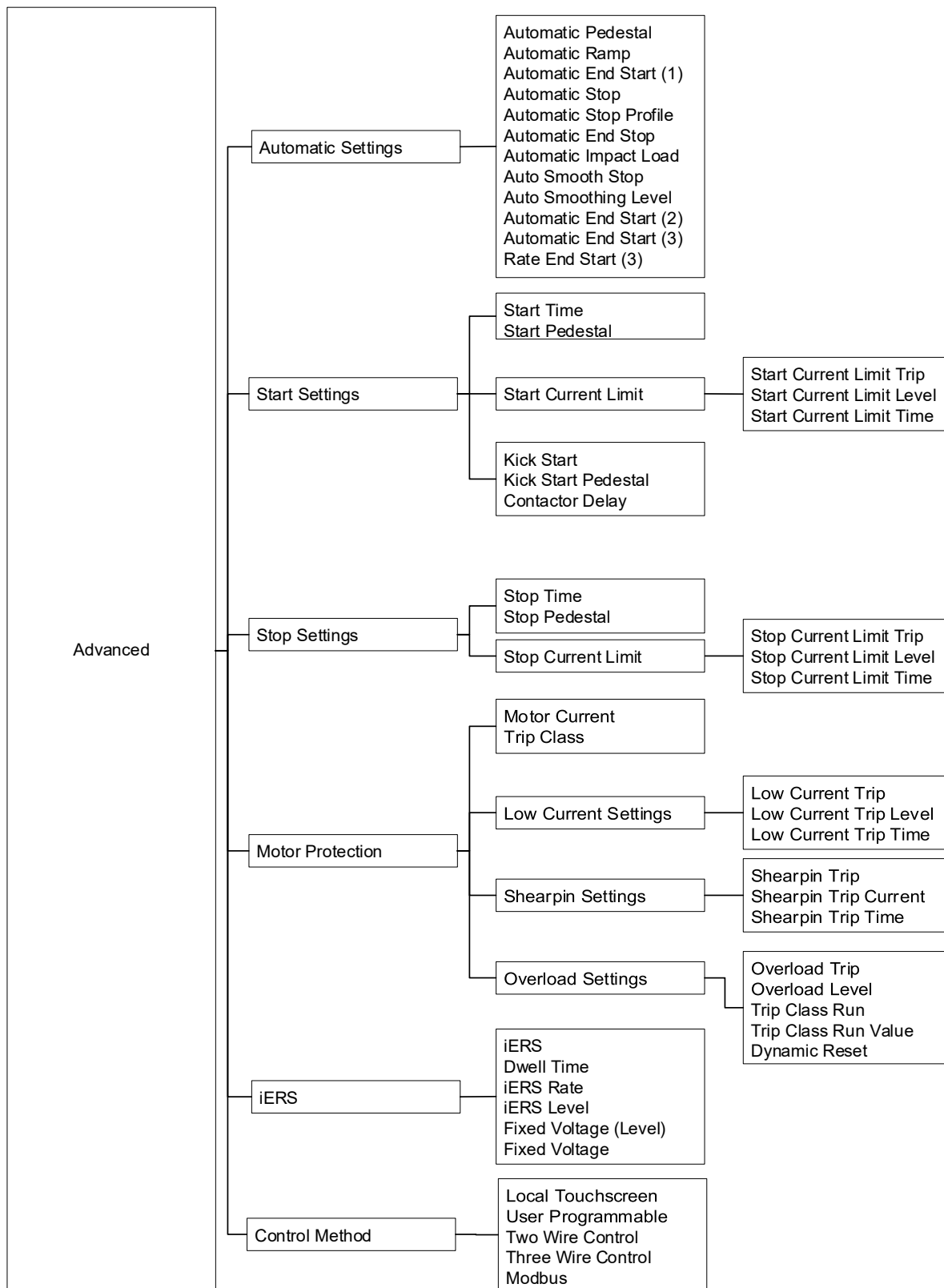

Operation

5.15.1 Advanced (continued)

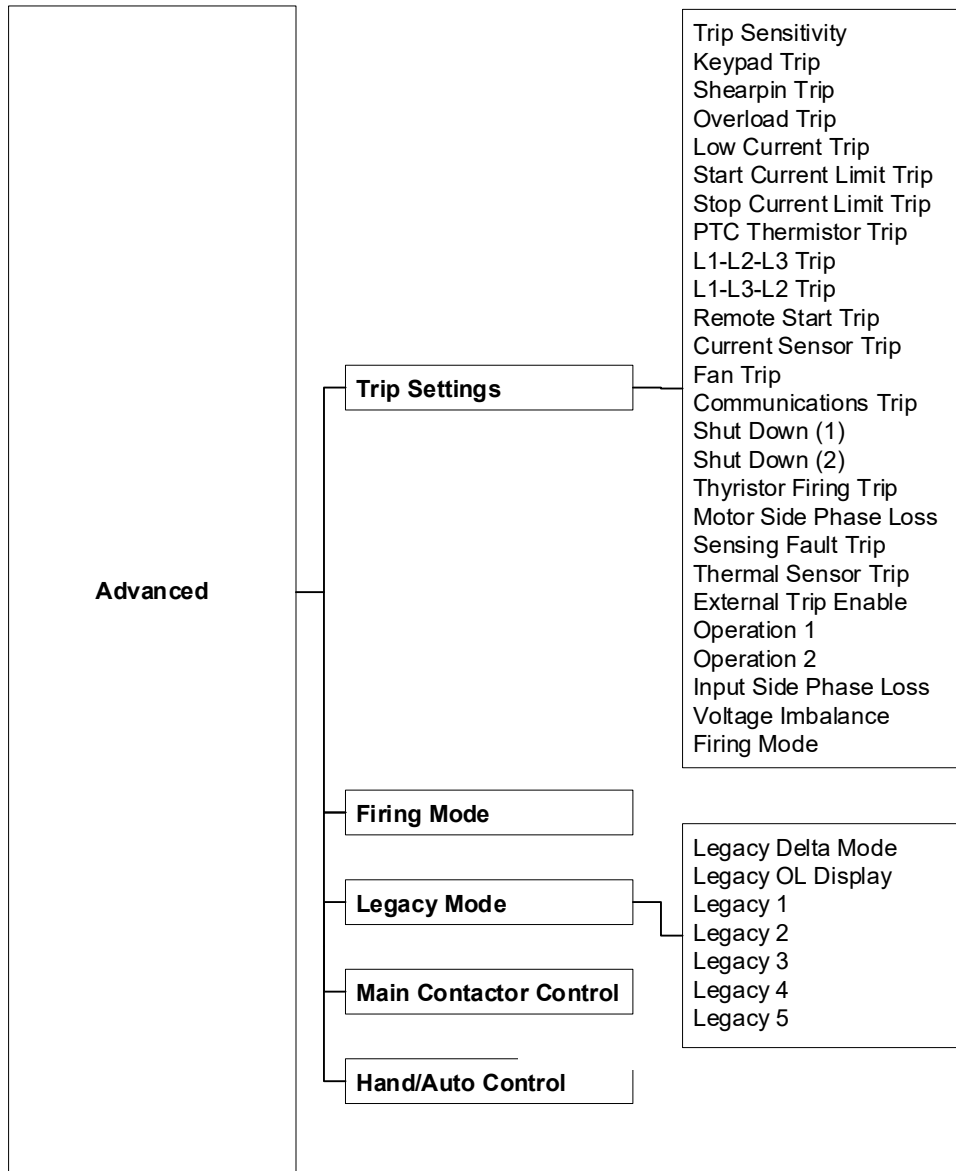

Operation

5.15.1 Advanced (continued)

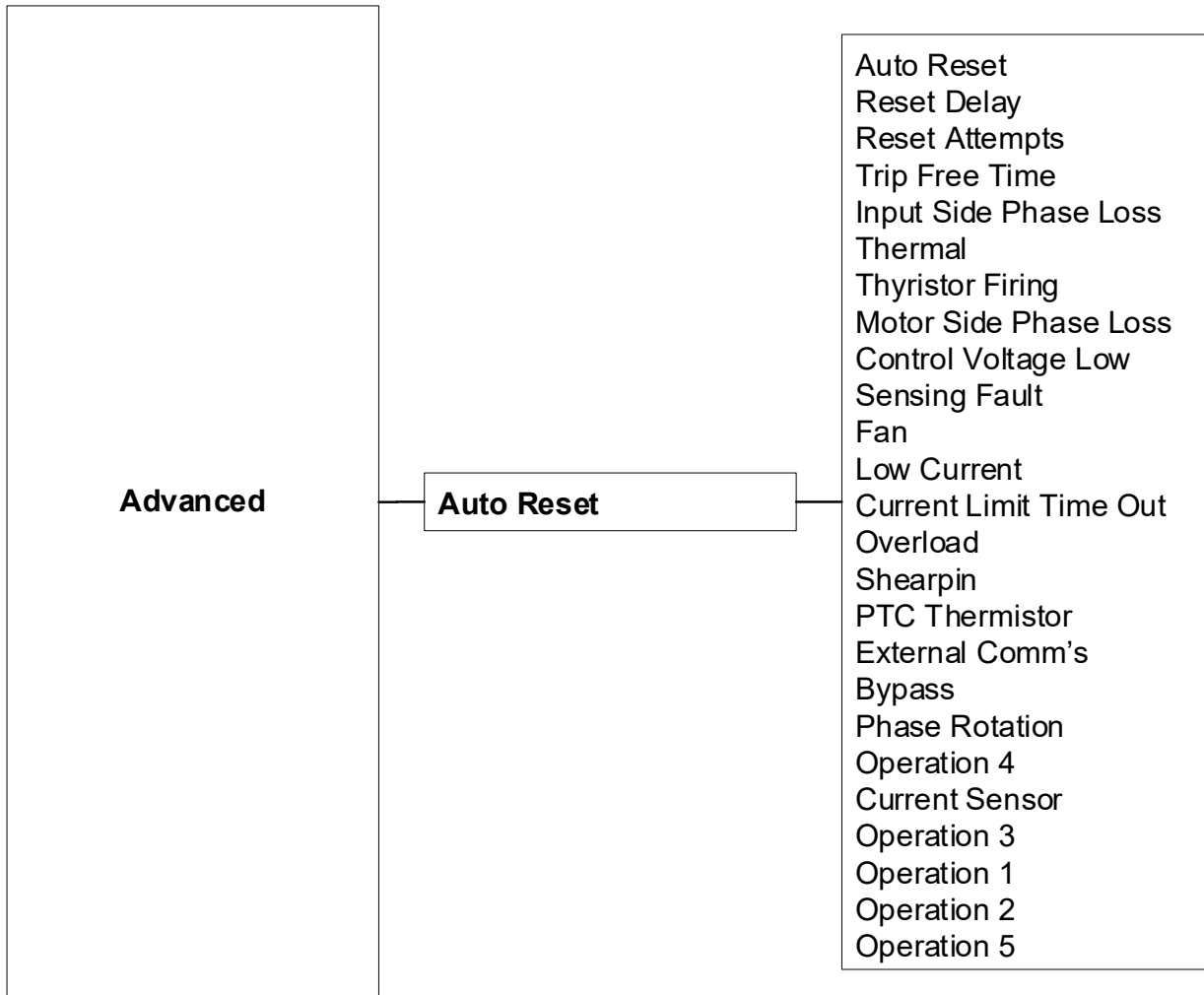

Operation

5.15.2 Input / output Menu

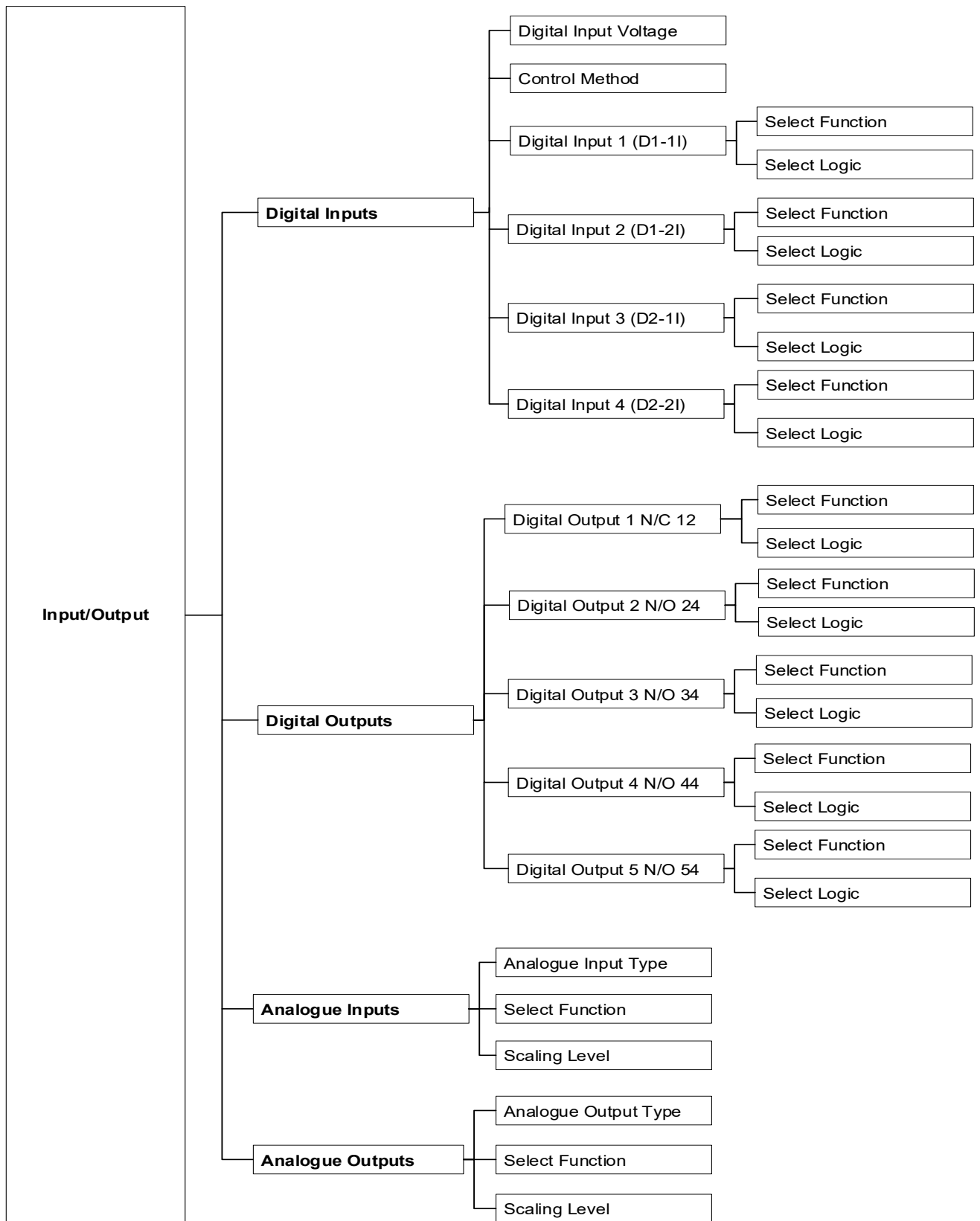

Operation

5.15.3 Monitor

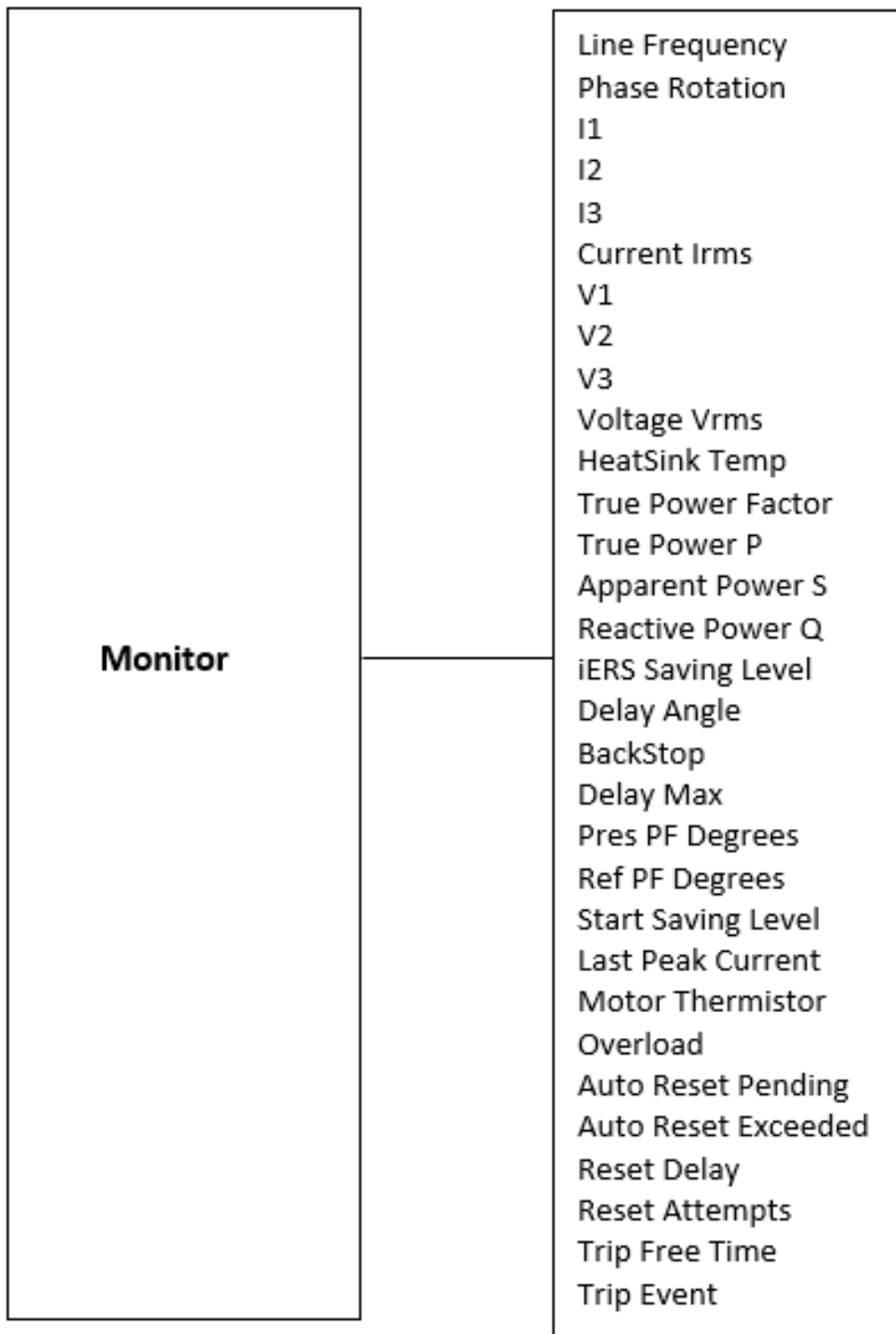

Operation

5.15.4 Log Menu

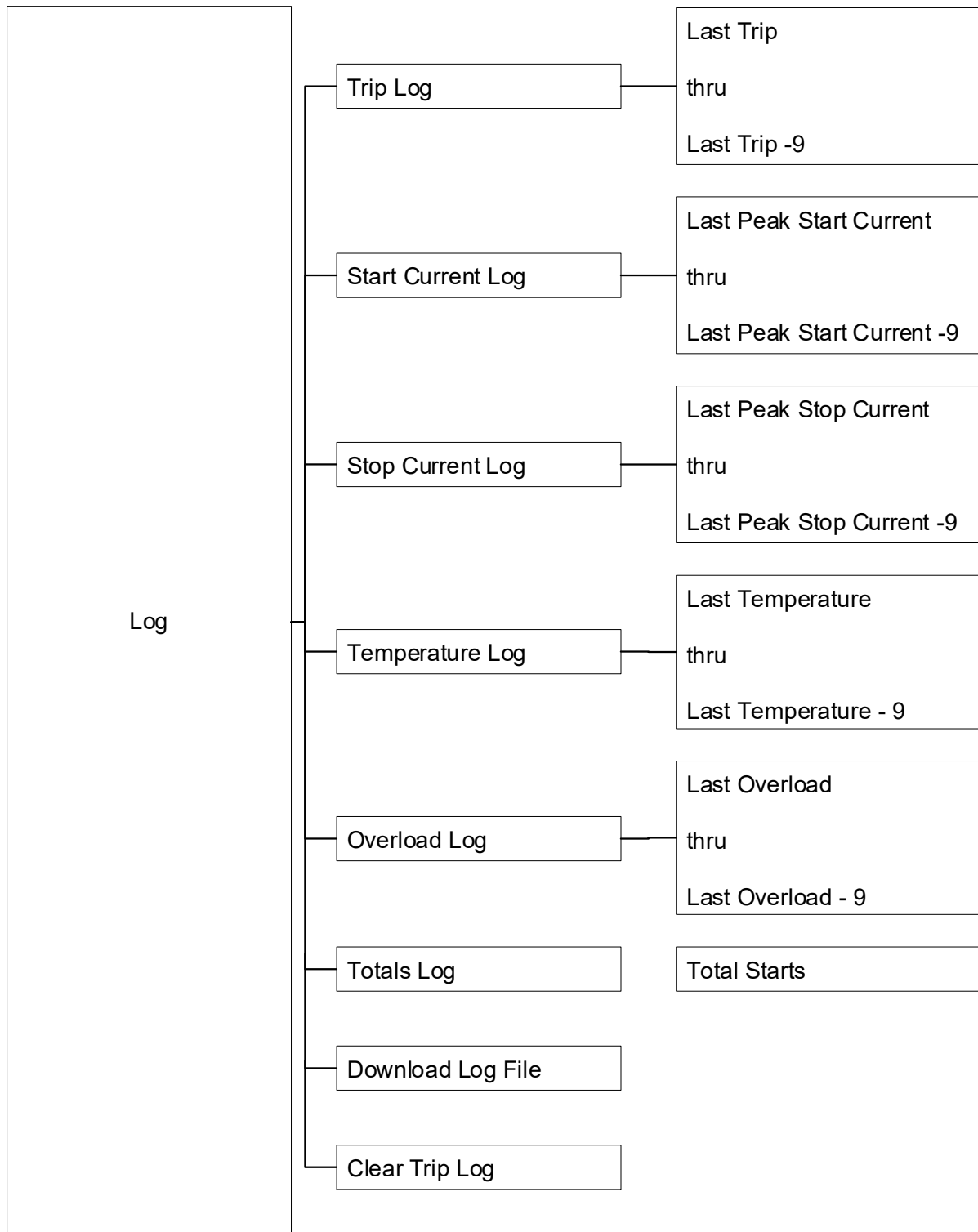

Trip and Fault Codes

6 Trip and Fault Codes

6.1 Trip Code Descriptions

Number & Name	Description
101 Input Side Phase Loss	<p>Phase L1 missing at the instant of start up.</p> <ul style="list-style-type: none"> The L1 phase is either missing or at a very low level. Check all incoming connections. If a main contactor is being controlled by a digital output set to "Running," check that "Contactor Delay" (under "Start Settings") is sufficient.
102 Input Side Phase Loss	<p>Phase L2 missing at the instant of start up.</p> <ul style="list-style-type: none"> The L2 phase is either missing or at a very low level. Check all incoming connections. If a main contactor is being controlled by a digital output set to "Running," check that "Contactor Delay" (under "Start Settings") is sufficient.
103 Input Side Phase Loss	<p>Phase L3 missing at the instant of start up.</p> <ul style="list-style-type: none"> The L3 phase is either missing or at a very low level. Check all incoming connections. If a main contactor is being controlled by a digital output set to "Running," check that "Contactor Delay" (under "Start Settings") is sufficient.
104 - 117 Input Side Phase Loss	<p>Any or all phases missing when the motor is being controlled (running).</p> <ul style="list-style-type: none"> L1, L2, or L3 are missing or at a very low level. Check all incoming connections. Check any fuses/breakers incorporated in the power circuit.
150 Voltage Imbalance Trip	<p>The three phase input voltages are imbalanced</p> <ul style="list-style-type: none"> The maximum voltage is determined, and the other voltages are compared to it. Check all incoming connections Check any fuses/ breakers incorporated in the power circuit.
201 Maximum Temperature Exceeded	<p>Internal heatsink temperature has exceeded 80°C.</p> <ul style="list-style-type: none"> It is possible the VMX-Synergy Plus™ is operating outside specified limits. Check enclosure ventilation and airflow around the VMX-Synergy Plus™ If the unit trips immediately, the internal temperature sensor could be faulty.
208 Thermal Sensor Trip	<p>Thermal sensor failure.</p> <ul style="list-style-type: none"> The internal temperature sensor has failed. Contact your supplier.
301-308 Thyristor Firing Trip	<p>One or more of the internal control thyristors (SCRs) have failed to turn on properly (In-Line "Firing Mode").</p> <ul style="list-style-type: none"> The VMX-Synergy Plus™ has detected that the SCRs are not operating as expected. Check all incoming and outgoing connections.

Trip and Fault Codes

6.1 Trip Code Descriptions (continued)

Number & Name	Description
350-358 Thyristor Firing Trip	<p>One or more of the internal control thyristors (SCRs) have failed to turn on properly (Delta "Firing Mode").</p> <ul style="list-style-type: none"> The VMX-Synergy Plus™ has detected that the SCRs are not operating as expected. <p>Check all incoming and outgoing connections.</p>
401 Motor Side Phase Loss	<p>One or all of the phases are missing on the motor side during the instant of start up.</p> <ul style="list-style-type: none"> T1, T2, or T3 are missing or at a very low level. Check that the motor is connected to T1, T2 and T3. Ensure any disconnecting device between the VMX-Synergy Plus™ and the motor is closed at the instant of start up.
402-403 Motor Side Phase Loss	<p>One or all of the phases are missing on the motor side during the instant of start up when the motor is being controlled.</p> <ul style="list-style-type: none"> T1, T2 or T3 are missing or at a very low level. Check all incoming and outgoing connections.
601 Control Voltage Too Low	<p>The internal control supply of the VMX-Synergy Plus™ level has fallen to a low level.</p> <ul style="list-style-type: none"> Can be caused by a weak 24Vdc/115Vac/230Vac control supply. Ensure 24Vdc/115Vac/230Vac supply meets the requirements specified in "Electrical Installation" Chapter 2 or the Quick Start Guide.
701-710 Sensing Fault Trip	<p>One or more of the internal control thyristors (SCRs) have failed to turn on properly.</p> <ul style="list-style-type: none"> The VMX-Synergy Plus™ has detected that the SCRs are not operating as expected. Check connections all incoming and outgoing connections.
801-802 Fan Problem	<p>One or more of the internal cooling fans has failed.</p> <ul style="list-style-type: none"> To ensure the heatsink is cooled sufficiently, the VMX-Synergy Plus™ will trip if the fans fail to operate. Check VMX-Synergy Plus™ fans for signs of damage or contamination.
1001 Short Circuit Thyristor	<p>One or more of the internal control thyristors (SCRs) have failed short circuit.</p> <ul style="list-style-type: none"> The VMX-Synergy Plus™ has detected that the SCRs are not operating as expected. Check all incoming and outgoing connections.
1101 Low Current Trip	<p>The motor current has been lower than the low trip level for the low trip time.</p> <ul style="list-style-type: none"> This trip is not active during soft start and soft stop and is "off" by default. If the low current trip is not required turn "off" in "Trip Settings".
1201 Current Limit Timeout Trip	<p>The motor has been held in current limit longer than the "Start Current Limit Time."</p> <ul style="list-style-type: none"> It is likely that the current limit level has been set too low for the application. Increase the current limit level or timeout period.
1202 Current Limit Timeout Trip	<p>The motor has been held in current limit longer than the "Stop Current Limit Time."</p> <ul style="list-style-type: none"> It is likely that the current limit level has been set too low for the application. Increase the current limit level or timeout period.
1301 Overload Trip	<p>The "Overload" has exceeded 100%.</p> <ul style="list-style-type: none"> The VMX-Synergy Plus™ is attempting to start an application that is outside its capacity or it is starting too often. Refer to the overload trip curves to determine whether the VMX-Synergy Plus™ has been sized correctly.

Trip and Fault Codes

6.1 Trip Code Descriptions (continued)

Number & Name	Description
1302 Overload Trip	The motor current has exceeded 475% (i-Synergy Plus) for a time greater than 250ms. <ul style="list-style-type: none"> The VMX-Synergy Plus™ is attempting to start an application that is outside its capacity with a “high current limit level” set. Refer to the overload trip curves to determine whether the VMX-Synergy Plus™ has been sized correctly and check current limit level.
1401 Shearpin Trip	The motor current has been higher than the “Shearpin Trip Level” for the “Shearpin Trip Time.” <ul style="list-style-type: none"> This trip is not active during soft start and soft stop and is “off” by default. If “Shearpin Trip” is not required, turn “off” in “Trip Settings.”
1501 PTC Thermistor Trip	The PTC thermistor value has exceeded the trip level (4kΩ). <ul style="list-style-type: none"> The PTC thermistor connected to the PTC input has exceeded its response temperature, or the PTC input is open circuit. If the PTC Trip is not required, turn “off” in “Trip Settings.”
1601 External Trip	External Trip <ul style="list-style-type: none"> The input programmed to External Trip is active If the External trip is not required turn "off" in "Trip settings"
1701 Communications Trip	Modbus RTU Communications failure. <ul style="list-style-type: none"> The command or status PNU has not been polled in the time set in the "Timeout" period The command or status PNU has not been polled in the time set in the "Timeout" period
1702 Communications Trip	Modbus TCP Communications failure. <ul style="list-style-type: none"> The command or status PNU has not been polled in the time set in the "Timeout" period If the communication trip is disabled, the Unit cannot be stopped if the communications fail
1703 Communications Trip	Anybus Communications failure. <ul style="list-style-type: none"> The command or status PNU has not been polled in the time set in the "Timeout" period If the communication trip is disabled, the Unit cannot be stopped if the communications fail
1704 Communications Trip	Keypad Communications failure. <ul style="list-style-type: none"> The communications bus has failed or become inactive between the keypad and the main unit. If the communication trip is disabled, the Unit cannot be stopped if the communications fail
1801-1802 Bypass Relay Trip	One or more of the internal bypass relays has failed to close. <ul style="list-style-type: none"> The internal bypass relay has failed, or the control supply is too weak. Ensure 24Vdc supply meets the requirements specified in “Electrical Installation” Chapter 2 or the Quick Start Guide.
1803 Bypass Relay Trip	One or more of the internal bypass relays has failed to open. <ul style="list-style-type: none"> The internal bypass relay has failed, or the control supply is too weak. Ensure 24Vdc supply meets the requirements specified in “Electrical Installation” Chapter 2 or the Quick Start Guide.
2001 Remote Start is Enabled	The Remote Start signal is active. <ul style="list-style-type: none"> The “Start/Stop” signal was active during power up or Reset. Turn off “Start/Stop,” or if Remote Start trip is not required, turn “off” in “Trip Settings.”
2101 Rotation L1 L2 L3 Trip	The input phase rotation is RYB (L1, L2, L3). <ul style="list-style-type: none"> The phase rotation is opposite to that required. Change phase rotation, or if “RYB” trip is not required, turn “off” in “Trip Settings.”

Trip and Fault Codes

6.1 Trip Code Descriptions (continued)

Number & Name	Description
2102 Rotation L1 L3 L2 Trip	The input phase rotation is RBY (L1, L3, L2). <ul style="list-style-type: none">• The phase rotation is opposite to that required.• Change phase rotation, or if “RBY” trip is not required turn “off” in “Trip Settings.”
2013 Rotation Undetermined Trip	The phase rotation is undetermined. <ul style="list-style-type: none">• The VMX-Synergy Plus™ is unable to determine whether the input phase rotation is L1, L2, L3 or L1, L3, L2.• Check all incoming and outgoing connections.
2201-2209 MPU Trip	Internal VMX-Synergy Plus™ failure of the main processing unit. <ul style="list-style-type: none">• The VMX-Synergy Plus™ has failed internally and is unable to recover automatically.• Cycle the control supply• If the fault is not cleared, contact your supplier.
2301-2303 Current Sensor Trip	Current sensor failure <ul style="list-style-type: none">• One or more of the internal sensors used to measure current has failed or is reading a low value.• Check the connections to the supply and motor as disconnection will result in a zero-current reading.• Check the plate FLA of the motor being controlled is at least 25% of the Motor Current set in the Protection menu
2701-2799 MPU Trip	Internal Unit Failure (MPU / Operation 5) <ul style="list-style-type: none">• The VMX-Synergy Plus™ has failed internally and is unable to recover automatically.• Cycle the control supply.• If the fault is not cleared, then contact the supplier

Trip and Fault Codes

6.2 Fail-Safe Codes

6.2.1 Main Board Trip Operation 2 (2402 – 2436)

A trip number in the range of 2402 to 2436 indicates that a process on the main board has been affected in some way and is unable to recover automatically.

- The trip is turned ON and OFF via the “Main Board Trip” (Advanced/Trips)
- The default for this trip is ON
- The trip MUST be reset using either the digital input, touchscreen, or bus command depending on the control method set.
- As this is a special case, it is NOT possible to reset this trip by cycling the control supply.

Code #	Description
2402	Initialization process has been unsuccessful.
2404	Initialization of the Parameters has been unsuccessful.
2406	Initialization of the Overload has been unsuccessful.
2408	Initialization of the Parameter Read has been unsuccessful.
2410	Initialization of the Overload Read has been unsuccessful.
2412	Initialization of the Current Measurement has been unsuccessful.
2420	A main process on the Main Board has been affected and is unable to recover automatically.
2422	A main process on the Main Board has been affected and is unable to recover automatically.
2424	A main process on the Main Board has been affected and is unable to recover automatically.
2426	Communication between the Main Board and Touchscreen Board has been affected and is unable to recover automatically.
2428	The Modbus communication has been affected and is unable to recover automatically.
2430	The parameter save has been unsuccessful.
2432	The logging function has been unsuccessful.
2434	A main process on the Main Board has been affected and is unable to recover automatically.
2436	The Anybus communication has been affected and is unable to recover automatically.

Trip and Fault Codes

6.2.2 Logging Operation 2 Trip (2601 – 2603)

Trip numbers that are in the range of 2601 to 2603 indicate that a process associated with the logging has been affected in some way and has been unable to recover automatically.

- The trip is turned ON and OFF via the “Logging Trip” (Advanced/Trips).
- The default for this trip is OFF.
- With the trip OFF, the logging function will temporarily be disabled if a continual failure is detected.
- When the trip is turned ON, it is reset using either the digital input or keypad or bus command, depending on the control method set.
- It is possible to reset this trip by cycling the control supply.

Code #	Description
2601	The initialization of the event logging function has been unsuccessful for 20 consecutive attempts.
2602	The event logging function has been unsuccessful for 20 consecutive attempts.
2603	The SD card could not be accessed after 20 consecutive attempts.

Communication

7 Communication

7.1 Modbus RTU Serial Communications

All VMX-Synergy Plus™ soft starts support Modbus RTU as standard. The RS-485 serial communications are accessible from the RJ45 connector (see below).

Note: ASCII and RTU transmission modes are defined in the Modbus protocol specification. VMX-Synergy Plus™ uses *only the RTU mode* for the message transmission.

For Modbus RTU parameter tables see MAN-VMX-SGY-MOD

7.1.1 Modbus RTU Connection

Dual RJ45 Socket Location and Pinout

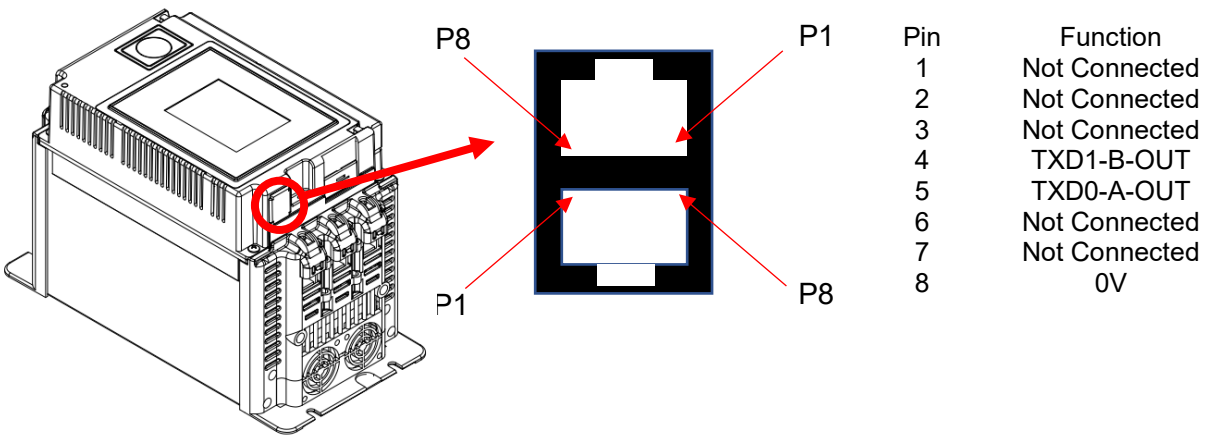

Single VMX-Synergy Plus™ to PLC

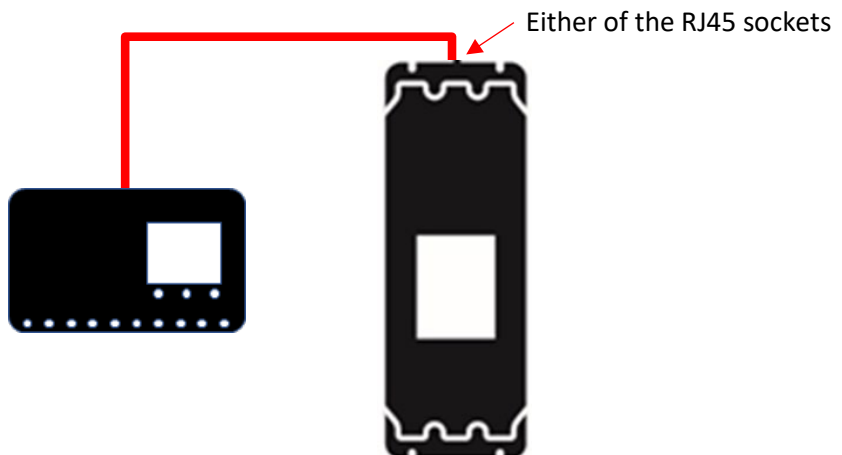

Communication

Multiple VMX-Synergy Plus™ to PLC

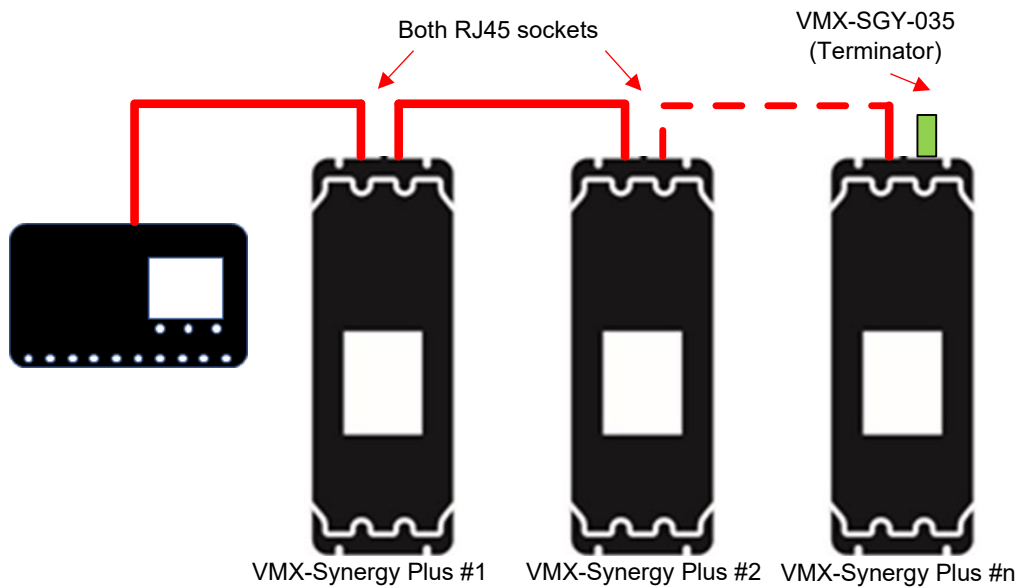

Ensure all units (including the PLC) have the same Baud rate and Parity.
Each VMX-Synergy Plus™ and the PLC must be set to different address numbers (1 to 32)

7.1.2 Modbus Communications Configuration

The Modbus communication settings may be configured from the Device menu:

- Device >> Networks >> Modbus Network Settings >> Address (1 – 32)
- Device >> Networks >> Modbus Network Settings >> Baud (9600 – 115200)
- Device >> Networks >> Modbus Network Settings >> Parity (Odd/Even)
- (Data bits = 8, Stop bits = 1)

The communication parameters should be set before connecting the Modbus master.

Communication

7.1.3 Message Structure for RTU Mode

The Modbus RTU structure uses a master-slave system for message exchange. In the case of the VMX-Synergy Plus™ system, it allows up to 32 slaves, and one master. Every message begins with the master making a request to a slave, which responds to the master in a defined structure. In both messages (request and answer), the used structure is the same: Address, Function Code, Data and CRC.

Master (request message):

Address (1 byte)	Function (1 byte)	Request Data (n bytes)	CRC (2 bytes)
---------------------	----------------------	---------------------------	------------------

Slave (response message):

Address (1 byte)	Function (1 byte)	Response Data (n bytes)	CRC (2 bytes)
---------------------	----------------------	----------------------------	------------------

Address

The master initiates the communication by sending a byte with the address of the destination slave. When responding, the slave also initiates the message with its own address. Broadcast to address 0 (zero) is not supported.

Function Code

This field contains a single byte, where the master specifies the type of service or function requested to the slave (reading, writing, etc.). According to the protocol, each function is used to access a specific type of data.

Data Field

The format and contents of this field depend on the function used and the transmitted value.

CRC

The used method is the CRC-16 (Cyclic Redundancy Check). This field is formed by two bytes; where first the least significant byte is transmitted (CRC-), and then the most significant (CRC+). The CRC calculation form is described in the Modbus RTU protocol specification.

7.1.4 Supported Functions

Modbus RTU specification defines the functions used to access different types of data. VMX-Synergy Plus™ parameters are defined as holding type registers.

Note that VMX-Synergy Plus™ Modbus addressing starts at zero; not 1 as some devices do.

VMX-Synergy Plus™ 32-bit parameters are High Word/Low Word in Modbus format.

The following services are available:

Communication

Read Holding Registers

Description: reading register blocks of holding register type (block R/W limited to 125 registers).

Function code: 03

<i>Query</i>		<i>Response</i>	
<i>Field</i>	<i>Hex Byte</i>	<i>Field</i>	<i>Hex Byte</i>
Slave address	01	Slave	01
Function	03	Function	03
Start address Hi	00	Byte count	02
Start address Lo	01	Data Hi	01
No of registers	00	Data Lo	2C
No of registers	01	CRC Lo	B8
CRC Lo	D5	CRC Hi	09
CRC Hi	CA		

Write Single Register

Description: writing in a single register of the holding type.

Function code: 06

<i>Query</i>		<i>Response</i>	
<i>Field</i>	<i>Hex Byte</i>	<i>Field</i>	<i>Hex Byte</i>
Slave address	01	Slave	01
Function	06	Function	06
Address Hi	00	Address Hi	02
Address Lo	0C	Address Lo	0C
Data Hi	00	Data Hi	00
Data Lo	09	Data Lo	09
CRC Lo	48	CRC Lo	88
CRC Hi	0C	CRC Hi	77

Communication

Write Multiple Registers

Description: writing register blocks of holding register type (block R/W limited to 125 registers).

Function code: 16

<i>Query</i>		<i>Response</i>	
<i>Field</i>	<i>Hex Byte</i>	<i>Field</i>	<i>Hex Byte</i>
Slave address	1	Slave address	1
Function	10	Function	10
Address Hi	00	Address Hi	00
Address Lo	0C	Address Lo	0C
No. Reg Hi	0	No. Reg Hi	0
No. Reg Lo	n	No. Reg Lo	n
No. Bytes	n* 2	Crc Lo	71
Data 1 Hi	00	Crc Hi	A3
Data 1 Low	0C		
..	...		
Data nn Hi	??		
Data nn Lo	??		
Crc Lo	48		
Crc Hi	0C		

(n is the number of holding registers could be any number between 1 and 125)

Memory Map

VMX-Synergy Plus™ Modbus communication is based on reading or writing equipment parameters from or to the holding registers. The data addressing is zero offset, such that the parameter Modbus address corresponds to the register number.

<i>Parameter Modbus Address</i>	<i>Modbus Data Address</i>	
	<i>Decimal</i>	<i>Hexadecimal</i>
0000	0	0000h
0001	1	0001h
.	.	.
.	.	.
.	.	.
.	.	.
0128	128	0080h
.	.	.
.	.	.
.	.	.
.	.	.

Communication

Message Timing

In the RTU mode there is no specific start or stop byte that marks the beginning or the end of a message. Indication of when a new message begins or when it ends is achieved by the absence of data transmission for a minimum period of 3.5 times the transmission time of a data byte. Thus, in case a message is transmitted after this minimum time has elapsed; the network elements will assume that the first received character represents the beginning of a new message.

Communication

7.2 Modbus Register Address Aliasing

When addressing the Modbus interface, the positioning/grouping of the existing function registers may make PLC programming difficult in some applications. Grouping of required monitoring, as well as programming, registers may affect the efficiency of the PLC when it requires block fetching and setting of data. With this in mind, the Synergy Plus Modbus address map has a section of user programmable registers, through which up to 16 register aliases can be set. Alongside these there are 16 four byte addresses that correspond with the aliases and act as the data conduits for each select address.

Alias Register Addresses	16 bit Alias Registers	Data Address	32 bit values (2 Word)
17600	e.g. 32000 (base 10)	17664	0x12345678 (HEX)
17601		17666	
17602		17668	
..		...	
..		...	
..		...	
17615		17696	

The table shows the relationship between the Alias Registers and the Data Registers. The data can take any data type that can fit into 4 bytes. So any address that yields 6 bytes data, such as time, will be incomplete. The access of 1 and 2 byte datum will have redundant bytes in the frame used. Below is an example of what will happen with different sizes.

Alias Address Addresses	Alias Addresses base10	Name	Data addresses	Data Shown in 4 Bytes. Greyed have no meaning or affect.			
17600	26880	Start I Limit	17664	0x00	0x00	0xe8	0x6c
17601	26944	Start I Time	17666	0x00	0x00	0x01	0x0e
17602	704	Start Pedestal	17668	0x00	0x00	0x0c	0xcd
17603	21120	iERS enabled	17670	0x00	0x00	0x00	0x00
17604	21184	iERS rate	17672	0x00	0x00	0x00	0x00
17605	21320	Start Saving Level	17674	0x00	0x00	0x00	0x00

Using the above example, the gathered values may be seen in the following diagram. In this instance block setting of the 6 remapped registers is shown.

Communication

7.1 Modbus Register Address Aliasing (continued)

Set the 6 aliased addresses into 6 registers starting from 17600. Note, there can be up to 16 addresses.

The screenshot shows the Modbus software interface with the following configuration:

- Device:** 1
- Command:** Write Holding Register(s)
- # Registers:** 6
- Function:** 16
- Register:** 17600
- Options:** Loop Command (unchecked), Error Checking (checked), Show Error Dialog (unchecked)

The status bar shows:

- Valid Response(s):** 00000000
- Error Response(s):** 00000000
- Timeout(s):** 00000000

The data log shows the following values for registers 001..016:

26880	26944	704	21120	21184	21320	0	0	0	0	0	0	0	0	0	0
-------	-------	-----	-------	-------	-------	---	---	---	---	---	---	---	---	---	---

Block read the associated data from 17664 for 12 registers (two registers for each datum).

The screenshot shows the Modbus software interface with the following configuration:

- Device:** 1
- Command:** Read Holding Register(s)
- # Registers:** 12
- Function:** 3
- Register:** 17664
- Options:** Loop Command (unchecked), Error Checking (checked), Show Error Dialog (unchecked)

The status bar shows:

- Valid Response(s):** 00000002
- Error Response(s):** 00000000
- Timeout(s):** 00000000

The data log shows the following values for registers 001..016:

0000h	E86Ch	0000h	001Eh	0000h	0CCDh	0000h	0001h	0000h	1000h	0000h	0000h	-	-	-	-
-------	-------	-------	-------	-------	-------	-------	-------	-------	-------	-------	-------	---	---	---	---

Optionally, the data can be modified and written back to the same registers.

The screenshot shows the Modbus software interface with the following configuration:

- Device:** 1
- Command:** Write Holding Register(s)
- # Registers:** 12
- Function:** 16
- Register:** 17664
- Options:** Loop Command (unchecked), Error Checking (checked), Show Error Dialog (unchecked)

The status bar shows:

- Valid Response(s):** 00000003
- Error Response(s):** 00000000
- Timeout(s):** 00000000

The data log shows the following values for registers 001..016:

0000h	E800h	0000h	1Fh	0000h	CCCh	0000h	0h	0000h	1001h	0000h	FFh	-	-	-	-
-------	-------	-------	-----	-------	------	-------	----	-------	-------	-------	-----	---	---	---	---

Communication

7.1 Modbus Register Address Aliasing (continued)

Reading back from the same registers it can be seen all the modified data. Note that the last “Start Saving Level” datum has not changed, since 21320 is a Read only register.

The screenshot shows a software interface for Modbus communication. At the top, there is a configuration table with columns: Device, Command, # Registers, and Function. Below this are checkboxes for 'Loop Command', 'Error Checking', and 'Show Error Dialog'. The 'Error Checking' checkbox is checked. Below the configuration is a control panel with 'Start' and 'Stop' buttons, and three digital displays for 'Valid Response(s)', 'Error Response(s)', and 'Timeout(s)', each with a 'Reset' button. The 'Valid Response(s)' display shows '00000004'. Below the control panel are tabs for 'Read Registers', 'Write Registers', 'Raw Data', and 'Data Log'. The 'Read Registers' tab is active, showing a table of register addresses and their corresponding hexadecimal values.

Device	Command	# Registers	Function	Loop Command	Error Checking	Show Error Dialog
1	Read Holding Register(s)	12	3	<input type="checkbox"/>	<input checked="" type="checkbox"/>	<input type="checkbox"/>
Register	Write Single Holding Register		6			
17664	Write Holding Register(s)	12	16			

Valid Response(s)	Error Response(s)	Timeout(s)
00000004	00000000	00000000

Read Registers	Write Registers	Raw Data	Data Log													
001. 016:	0000h	E800h	0000h	001Fh	0000h	0CCCh	0000h	0000h	0000h	1001h	0000h	0000h	-	-	-	-
017. 032:	-	-	-	-	-	-	-	-	-	-	-	-	-	-	-	-

Once set the addresses can be saved in non-volatile memory if required. However, given that this is a programmable feature, best practice would be to program the aliases at the start of a PLC session. Saving can be done by either using the “Save Parameter” button in the Advanced section of the keypad, or by setting appropriate Modbus register (62144). The alias being processed may be cleared by setting each Alias Register Address to 0 or by performing a factory default.

Appendices

Appendix 1

A1.0 Updating VMX-Synergy Plus™ Firmware

1. Insert the USB flash drive into the USB connector on the VMX-Synergy Plus™ unit.

2. Use the touchscreen to navigate to the Update Firmware selection button. Home >> Device >> Update Firmware.

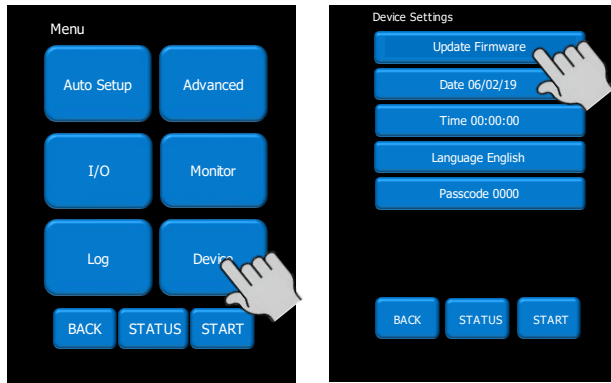

3. The next screen shows the 'current' installed firmware version and the firmware version previously copied to the USB flash drive. Press the Start Firmware Update button. Confirm the update

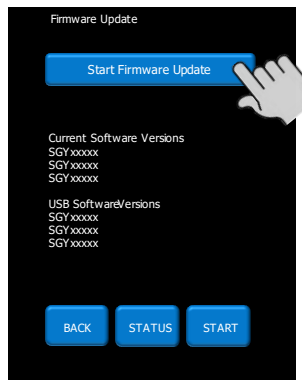

ENSURE POWER IS NOT REMOVED FROM THE UNIT DURING THE FIRMWARE UPDATE

Appendices

A1.1 Updating VMX-Synergy Plus™ Keypad Firmware

1. Remove the keypad using the release points shown in Section 2.9 -External Features
2. Insert the USB flash drive into the USB connector on the Keypad.

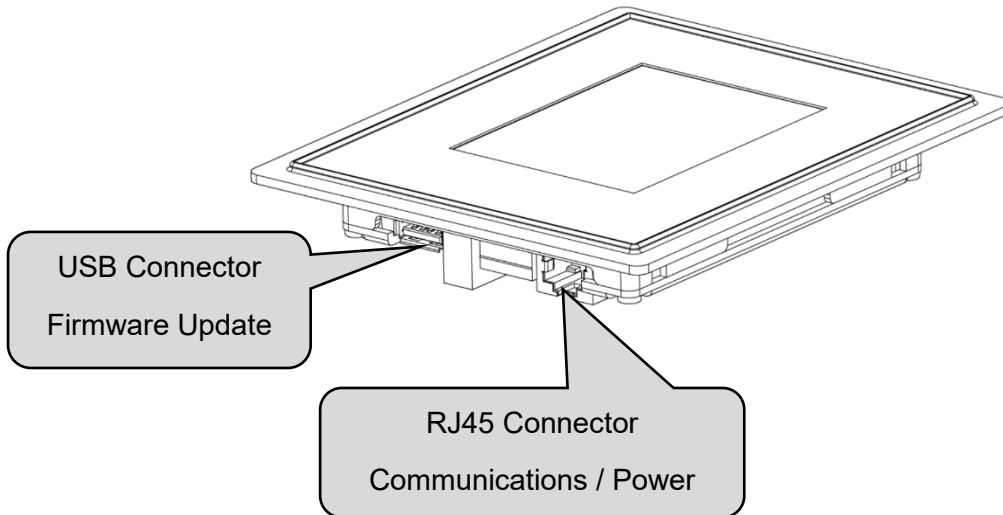

2. Use the touchscreen to navigate to the Update Firmware selection button. Home >> Device >> Update Firmware.

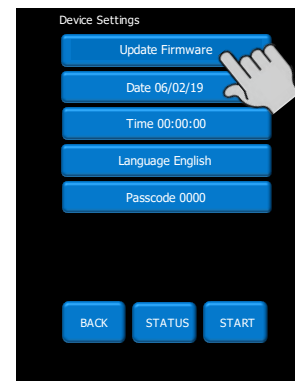
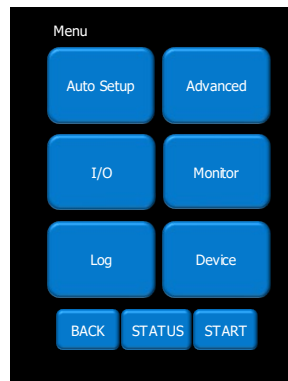

3. The next screen shows the 'current' installed firmware version and the firmware version previously copied to the USB flash drive. Press the Start Firmware Update button. Confirm the update

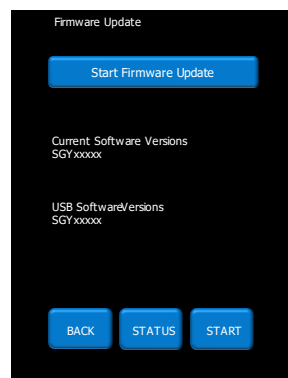

ENSURE POWER IS NOT REMOVED FROM THE UNIT DURING THE FIRMWARE UPDATE

Appendices

Appendix 2

A2.0 Remote Installation of the Touchscreen

If required, the VMX-Synergy Plus™ touchscreen may be removed and located remotely – for instance, on the enclosure door.

Procedure

1. Remove keypad from front of unit.
2. Remove short cable
3. Peel off backing on one side only of the provided pressure sensitive adhesive gasket. Attach the gasket to the back of the keypad.
4. Peel off the backing from the gasket attached to the keypad.
5. Place keypad on the outside of door or panel with a 91mm (3.6") (91mm) by 112 mm (4.4") inch cutout.
6. Attach the long cable to the keypad in place of the removed short one.
7. Remove orientation label after install is complete.

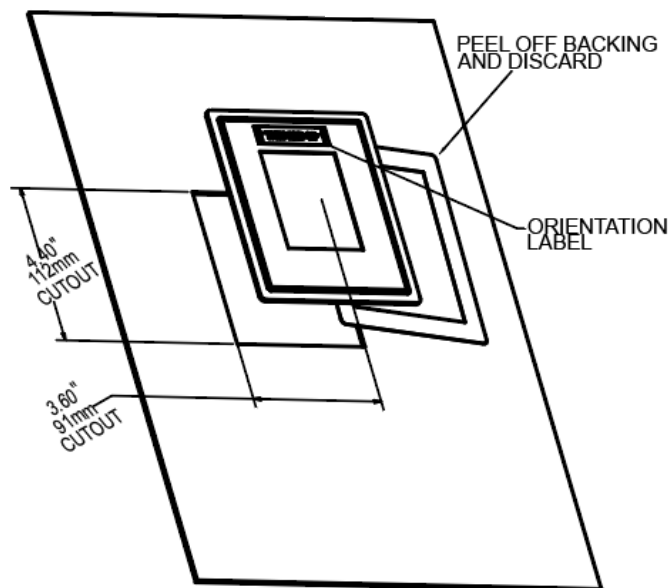
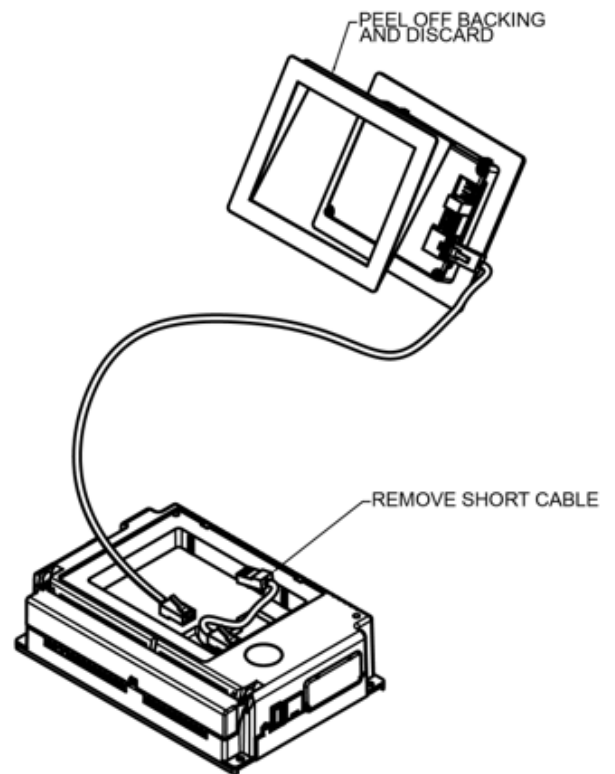

Electric current, Danger to life!

Only skilled or instructed persons may carry out the operations.

Lebensgefahr durch Strom!

Nur Elektrofachkräfte und elektrotechnisch unterwiesene Personen dürfen die im Folgenden beschriebenen Arbeiten ausführen.

Tension électrique dangereuse!

Seules les personnes qualifiées et averties doivent exécuter les travaux ci-après.

¡Corriente eléctrica! ¡Peligro de muerte!

El trabajo a continuación descrito debe ser realizado por personas cualificadas y advertidas.

Tensione elettrica: Pericolo di morte!

Solo persone abilitate e qualificate possono eseguire le operazioni di seguito riportate.

触电危险!

只允许专业人员和受过专业训练的人员进行下列工作。

Электрический ток! Опасно для жизни!

Только специалисты или проинструктированные лица могут выполнять следующие операции.

Levensgevaar door elektrische stroom!

Uitsluitend deskundigen in elektriciteit en elektrotechnisch geïnstrueerde personen is het toegestaan, de navolgend beschreven werkzaamheden uit te voeren.

Livsfare på grund af elektrisk strøm!

Kun uddannede el-installatører og personer der er instruerede i elektrotekniske arbejdsopgaver, må udføre de nedenfor anførte arbejder.

Προσοχή, κίνδυνος ηλεκτροπληξίας!

Οι εργασίες που αναφέρονται στη συνέχεια θα πρέπει να εκτελούνται μόνο από ηλεκτρολόγους και ηλεκτροτεχνίτες.

Perigo de vida devido a corrente eléctrica!

Apenas electricistas e pessoas com formação electrotécnica podem executar os trabalhos que a seguir se descrevem.

Livsfara genom elektrisk ström!

Endast utbildade elektriker och personer som undervisats i elektroteknik får utföra de arbeten som beskrivs nedan.

Hengenvaarallinen jännite!

Vain pätevät sähköasentajat ja opastusta saaneet henkilöt saavat suorittaa seuraavat työt.

Nebezpečí úrazu elektrickým proudem!

Niže uvedené práce smějí provádět pouze osoby s elektrotechnickým vzděláním.

Eluotlik! Elektrilöögiht!

Järgnevalt kirjeldatud töid tohib teostada ainult elektriala spetsialist või elektrotehnilise instrueerimise läbinud personal.

Életveszély az elektromos áram révén!

Csak elektromos szakemberek és elektrotechnikában képzett személyek végezhetik el a következőkben leírt munkákat.

Elektriskā strāva apdraud dzīvību!

Tālāk aprakstītos darbus drīkst veikt tikai elektrospeciālisti un darbam ar elektrotehniskām iekārtām instruētās personas!

Porazenie prądem elektrycznym stanowi zagrożenie dla życia!

Opisane poniżej prace mogą przeprowadzać tylko wykwalifikowani elektrycy oraz osoby odpowiednio poinstruowane w zakresie elektrotechniki.

Livsfara genom elektrisk ström!

Endast utbildade elektriker och personer som undervisats i elektroteknik får utföra de arbeten som beskrivs nedan.

Hengenvaarallinen jännite!

Vain pätevät sähköasentajat ja opastusta saaneet henkilöt saavat suorittaa seuraavat työt.

Nebezpečí úrazu elektrickým proudem!

Niže uvedené práce smějí provádět pouze osoby s elektrotechnickým vzděláním.

Eluotlik! Elektrilöögiht!

Järgnevalt kirjeldatud töid tohib teostada ainult elektriala spetsialist või elektrotehnilise instrueerimise läbinud personal.

Életveszély az elektromos áram révén!

Csak elektromos szakemberek és elektrotechnikában képzett személyek végezhetik el a következőkben leírt munkákat.

Elektriskā strāva apdraud dzīvību!

Tālāk aprakstītos darbus drīkst veikt tikai elektrospeciālisti un darbam ar elektrotehniskām iekārtām instruētās personas!

Pavojus gyvybei dėl elektros srovės!

Tik elektrikai ir elektrotechnikos specialistai gali atlikti žemiau aprašytus darbus.

Porazenie prądem elektrycznym stanowi zagrożenie dla życia!

Opisane poniżej prace mogą przeprowadzać tylko wykwalifikowani elektrycy oraz osoby odpowiednio poinstruowane w zakresie elektrotechniki.

Življenjska nevarnost zaradi električnega toka!

Spodaj opisana dela smejo izvajati samo elektrostrokovnjaki in elektrotehnično poučene osebe.

Nebezpečnostv ohrozenia života elektrickým prúdom!

Práce, ktoré sú nižšie opísané, smú vykonávať iba elektroodborníci a osoby s elektrotechnickým vzdelaním.

Опасност за живота от электрически ток!

Операциите, описани в следващите раздели, могат да се извършват само от специалисти-електротехници и инструктиран електротехнически персонал.

Atenție! Pericol electric!

Toate lucrările descrise trebuie efectuate numai de personal de specialitate calificat și de persoane cu cunoștințe profunde în electrotehnică.

Življenjska nevarnost zaradi električnega toka!

Spodaj opisana dela smejo izvajati samo elektrostrokovnjaki in elektrotehnično poučene osebe.

Nebezpečnostv ohrozenia života elektrickým prúdom!

Práce, ktoré sú nižšie opísané, smú vykonávať iba elektroodborníci a osoby s elektrotechnickým vzdelaním.

Опасност за живота от электрически ток!

Операциите, описани в следващите раздели, могат да се извършват само от специалисти-електротехници и инструктиран

Atenție! Pericol electric!

Toate lucrările descrise trebuie efectuate numai de personal de specialitate calificat și de persoane cu cunoștințe profunde în electrotehnică.

Pavojus gyvybei dėl elektros srovės!

Tik elektrikai ir elektrotechnikos specialistai gali atlikti žemiau aprašytus darbus.

California Customers: California Proposition 65 Warning

WARNING: this product and associated accessories may contain chemicals known to the State of California to cause cancer, birth defects, or other reproductive harm. For more information visit <https://p65warnings.ca.gov>

MAN-VMX-SGY-I-UM-V04

17/08/2021



MOTORTRONICS™

Solid State AC Motor Control

VMX-Synergy Plus™

Premium Digital Soft Starter

www.motortronics.com