





# FREQUENCY => CURRENT / VOLTAGE CONVERTER Z111

## GENERAL FEATURES

- Pulse input for all the most commonly-used sensors: mechanical contact, reed, npn with 2 and 4 wires, pnp with 3 wires and 24V DC power supply, Namur, photoelectric, variable reluctance, 24V and TTL pulses
- Maximum frequency from 1 mHz to 9.99 KHz, selectable fullscale from 10 mHz to 9.99 KHz;
- Full-scale can be easily set using rotating switches;
- Selection of the output mode (0/4.20 mA, 0/1..5V , 0/2..10V) using dip-switches;
- Possibility to set the number of pulses for the calculation of the pulse average;
- Indication of power supply presence and out-of-scale errors provided on front panel;
- 3-point insulation: 1500V AC.

## TECHNICAL SPECIFICATIONS

Power supply:	10..40 Vdc, 19..28 Vac 50..60 Hz, max 2,5 W
Input:	Pulses: mechanical contact, reed , npn with 2 and 3 wires , pnp with 3 wires and 24V DC power supply, Namur, photoelectric, "HALL" sensor, and variable reluctance. Maximum frequency 9.99 KHz
Output:	Active current 0..20 mA / 4..20 mA, max. load resistance: 600 ohm Voltage 0..5 V / 0..10 V / 1..5 V / 2..10 V , min. load resistance: 2500 ohm Error : < 0.3% of F.S.
Work conditions:	Temperature: 0 - 50°C , Min. humidity: 30% , Max. humidity: 90% at 40°C (non condensing)
Standards:  	The instrument conforms to the following standards: EN50081-2 (electromagnetic emission, industrial environments) EN50082-2 (electromagnetic immunity, industrial environments) EN61010-1 (safety) Notes: - Use with copper conductor. - Use in Pollution Degree 2 Environment . - Power Supply must be Class 2. - When supplied by an Isolated Limited Voltage/Limited Current power supply a fuse rated max 2.5A shall be installed in the field.

## INSTALLATION RULES

The Z111 modules have been designed for mounting on DIN 46277 guides in vertical position.

For long-lasting and optimum working life, the module(s) must be ensured adequate ventilation. Make sure to position the cable raceways and any other objects in such way as to avoid clogging the ventilation slots.

Also avoid positioning the modules above equipment that generates heat. For this reason, we recommend performing installation in the lower part of the panel.

### TAXING WORK CONDITIONS:

The following are considered taxing work conditions:

- *elevated power supply voltage (> 30V DC / > 26 V AC)*
- *providing power supply to sensor input.*
- *use of the active current output.*

When paired modules are installed, **they may require separation by at least 5 mm** in the following cases:

- With panel temperatures of more than 45°C in concomitance with at least one of the taxing work conditions above.
- With panel temperatures of more than 35°C in concomitance with at least two of the taxing work conditions above.

# ELECTRICAL CONNECTIONS

We recommend using shielded cables for the connection of the signals; the shield must be connected to a designated ground connection for the instrumentation. We also discourage passing the wires near the power supply cables for inverters, motors, or induction ovens, etc.

## POWER SUPPLY

- 2 — 19 ÷ 28 V~
- 3 — 19 ÷ 40 V=

The power supply voltage must be between 19 and 40 V DC (polarity not important), 19 and 28 V AC; also see the section entitled "**INSTALLATION RULES**".

**The upper limits must never be exceeded at the risk of creating serious damage to the module.**

The power supply source must be protected against all risk of module malfunction by the use of an well sized fuse.

## INPUTS

Contact / Reed    NPN (2 wires)    NPN 24V (3 wires)    PNP 24V (3 wires)

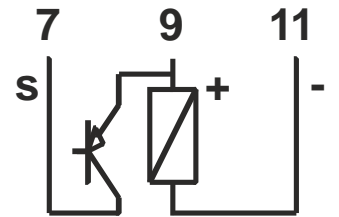
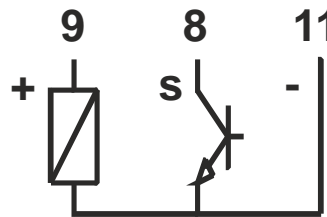
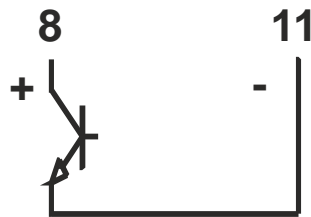
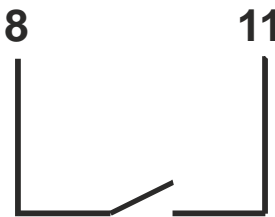

NAMUR

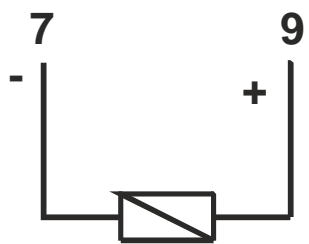
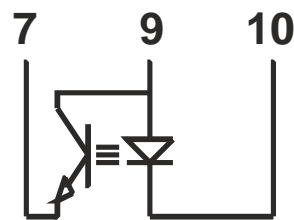
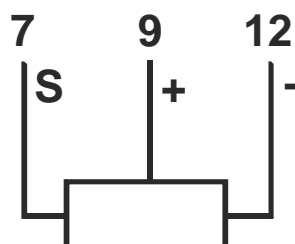

Photo-electric



"HALL" sensor



Input 24V

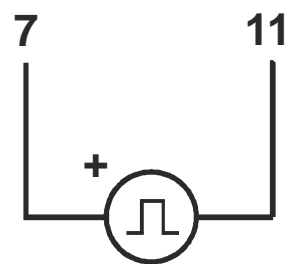

TTL input

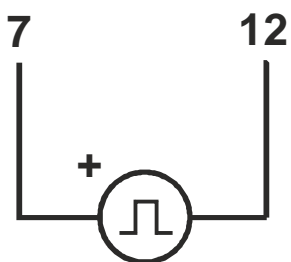

Variable reluctance

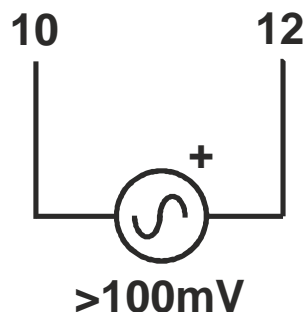

Turbine or oval gear "AICHI"

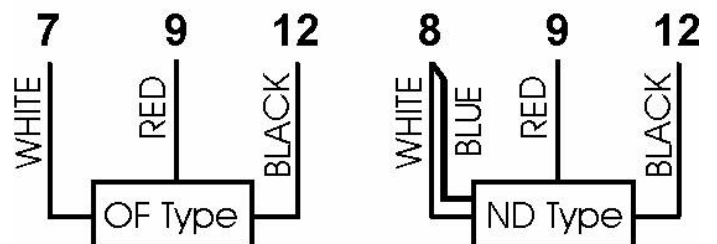

**NOTE :** In order to permit the use of the variable reluctance type input, the internal jumpers must be selected.

*Before setting the internal jumpers, the container's lateral closing panel must be removed by pulling it slightly outward. The instrument is supplied with internal jumpers set for **standard inputs**.*

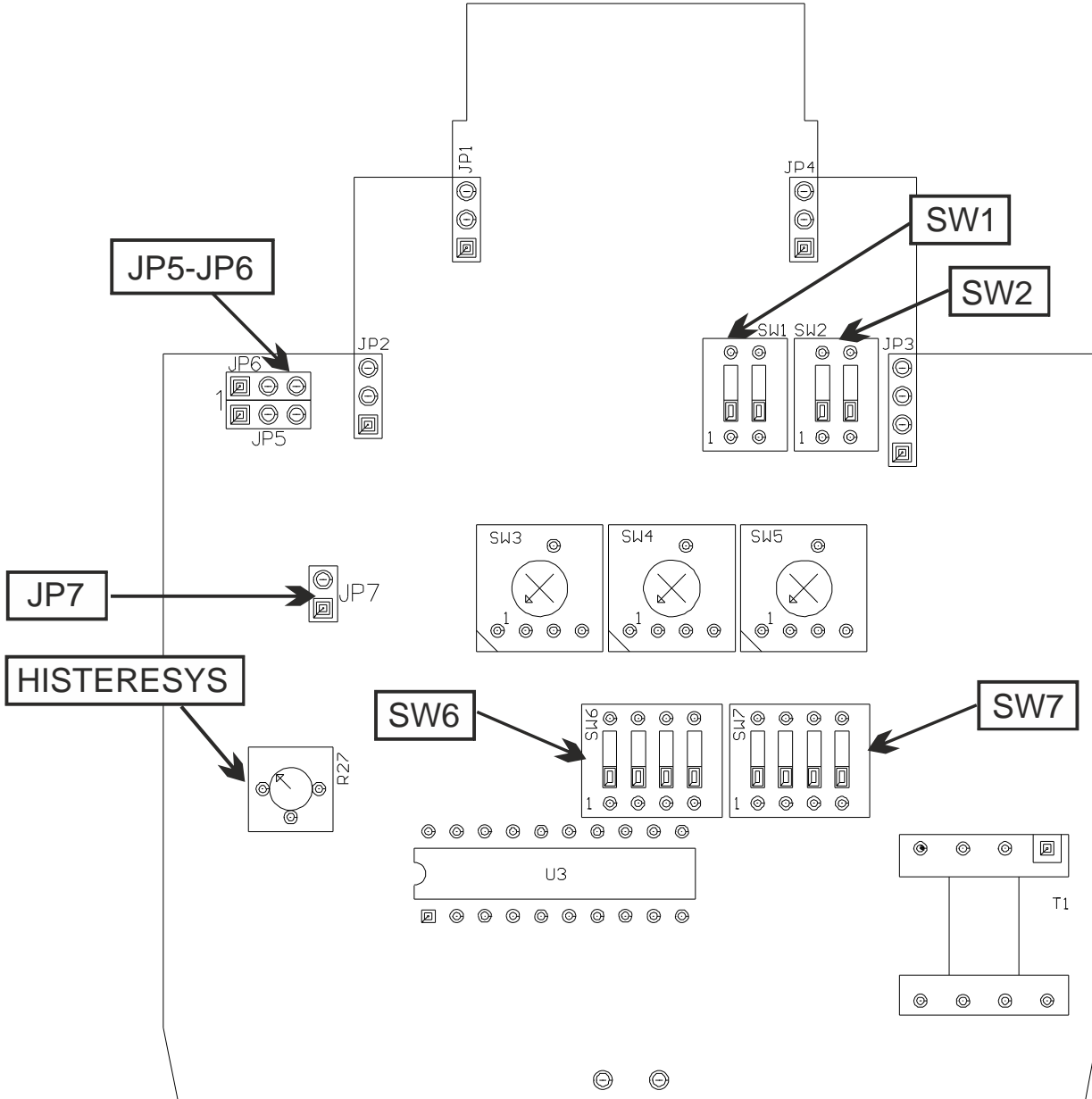

**Internal jumper setting for standard inputs:**

- JP5** in position 2-3
- JP6** in position 2-3
- JP7** open

**Internal jumper setting for variable reluctance inputs:**

- JP5** in position 1-2
- JP6** in position 1-2
- JP7** closed

Note: Pin number 1 on jumpers JP5 and JP6 stands on the left while looking at the card from the front.

# HISTERESYS CALIBRATION

This operation is only performed when the “variable reluctance” input is used.

For the hysteresis calibration, after first correctly setting the internal jumpers and the full-scale frequency, a tester must be connected to the device's output (it makes no difference whether the voltage or current output is used) and an input signal must be provided; then using a screwdriver, rotate the hysteresis trimmer completely counter-clockwise (the tester should indicate 0) and then the trimmer must be slowly rotated clockwise until the tester provides a stable input reading. At this point, rotate the trimmer clockwise by around 5% in order to have a sufficient calibration safety margin.

NOTE : remember that the minimum signal amplitude is 100 mV.

---

## RETRANSMITTED OUTPUT

Voltage

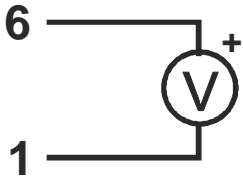

Active current

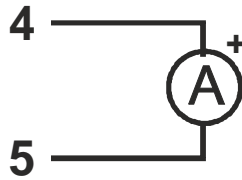

Ext. power supply current

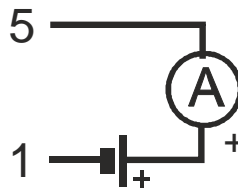

---

## FILTER SETTING

### SW6 - FILTER

 Filter OFF

 Filter ON

Whenever the input frequency is unstable, a filter can be set to stabilise the output signal. In order to set this filter, position **SW6** dip-switch no. 1 in the **ON** position (by shifting it upwards).

**N.B.:** The dip-switches must be set after first disconnecting power supply from the module in order to avoid damaging the module.

## RESPONSE TIME

RANGE	RESPONSE TIME	Led error after
x 0,0001	25 sec	1000 sec
x 0,001	2,5 sec	100 sec
x 0,01	0,25 sec	10 sec
x 0,1	0,25 sec	10 sec
x 1	0,25 sec	10 sec
x 10	0,25 sec	10 sec

# INPUT FREQUENCY SETTING

The input signal full-scale frequency can be easily set.

The three rotating selectors permit the setting of a value which when multiplied by the multiplication factor will provide the input signal full-scale frequency.

*Example 1 :* if the input frequency full-scale value = 563 Hz, the hundredths (100's) selector must be set to 5, the tenths (10's) selector must be set to 6, and the units (1's) selector must be set to 3. The multiplier must be set to x 1 ( $563 \times 1 = 563$  Hz).

*Example 2 :* if the input frequency full-scale value = 7850 Hz, the hundredths (100's) selector must be set to 7, the tenths (10's) selector must be set to 8, and the units (1's) selector must be set to 5. The multiplier must be set to x 10 ( $7850 \times 10 = 7850$  Hz).

**NOTE 1 :** The hundredths selector (100's) cannot be set to 0; the minimum full-scale value must therefore be 0,01 Hz.

**NOTE 2 :** The "Error" led blink if the input frequency is less lower than the values indicated in the table or more than selected fullscale.

## Multiplier setting



## Frequency setting selectors

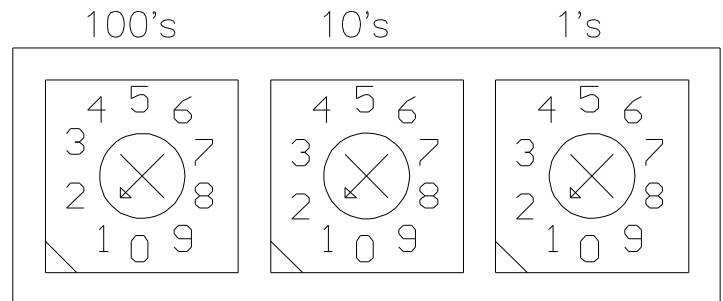

**NOTE: Dip-switch and rotating selector setting must be performed after first disconnecting module power supply in order to avoid damaging the module.**

## PULSE AVERAGE SETTING

Whenever the input signals present cyclically unstable frequency, a number of pulses on which the frequency measurement will be calculated can be set.

*Example :* the input signal is provided by a proximity sensor that indicates the passage of a number of bolts mounted on a wheel; if these bolts are not positioned at equal distances, an unstable sensor output frequency value will occur and this will create an unstable module Z11 output current and/or voltage value.

By setting the number of bolts applied to the wheel, such as 10, for example, as the “pulse average”, the device will count 10 pulses and then divide the time that elapses between the first and the last pulse by 10. This operation will permit an extremely stable module output signal to be obtained.

### SW7 - PULSE AVERAGE

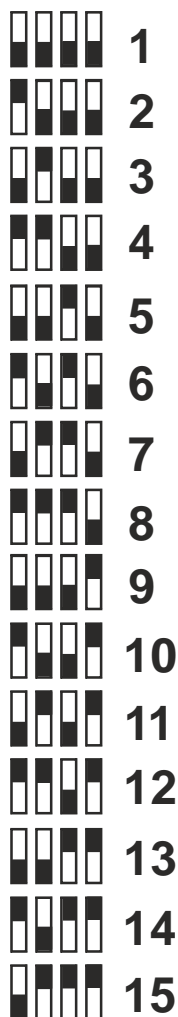

**NOTE :** if pulse average calculation is not required, leave all the **SW7** selector dip-switches **OFF** (shifted down).

**NOTE:** Dip-switch setting must be performed after first disconnecting module power supply in order to avoid damaging the module.

**NOTE:** The minimum measured frequency is normally **0.001Hz**. When the pulse average is set over **6**, the minimum frequency will be  **$n / 6000$** .

Ex: pulse average = 8 ,  
 $f_{\min} = 8/6000 = 0.00133\text{Hz}$ .

## OUTPUT SELECTION

### SW1 - OUTPUT MODE

 0..20mA/0..5V/0..10V

 4..20mA/1..5V/2..10V

### SW2 - OUTPUT VOLTAGE

 0/1..5V

 0/2..10V

SW1 unit dip-switches number 1 and 2 permit setting the setting of the output with or without zero elevation respectively.

SW2 unit dip-switches permit the selection of the output voltage.

**NOTE: Dip-switch setting must be performed after first disconnecting module power supply in order to avoid damaging the module.**



Disposal of Electrical & Electronic Equipment (Applicable throughout the European Union and other European countries with separate collection programs)

This symbol, found on your product or on its packaging, indicates that this product should not be treated as household waste when you wish to dispose of it. Instead, it should be handed over to an applicable collection point for the recycling of electrical and electronic equipment. By ensuring this product is disposed of correctly, you will help prevent potential negative consequences to the environment and human health, which could otherwise be caused by inappropriate disposal of this product. The recycling of materials will help to conserve natural resources. For more detailed information about the recycling of this product, please contact your local city office, waste disposal service or the retail store where you purchased this product.

This document is property of SENECA srl. Duplication and reproduction are forbidden, if not authorized. Contents of the present documentation refers to products and technologies described in it. All technical data contained in the document may be modified without prior notice Content of this documentation is subject to periodical revision.



**SENECA s.r.l.**

Via Austria, 26 - 35127 - PADOVA - ITALY

Tel. +39.049.8705355 - 8705359 - Fax +39.049.8706287

e-mail: [info@seneca.it](mailto:info@seneca.it) - [www.seneca.it](http://www.seneca.it)